

KRAFT

AGRITECH 2024-2025

Makineri Bujqësie
Makineri Kopshtarie
Pompa Uji dhe Lavazhe
Materiale Elektrike
Artikuj Hidraulik
Produkte Familjare



30

KRAFT VITE

“Besimi juaj është Forca jonë për të vazhduar,”

Të dashur partnerë,

Katalogu aktual që keni në duart tuaja, përmbledh gjithë rrugëtimin tonë të biznesit dhe është një mjet, që do të kontribuojë ndjeshëm në zhvillimin e biznesit tuaj. Prej 30 vitesh kemi zhvilluar baza të forta, për shërbimin optimal të dyqaneve të veglave të punës dhe kopshtarisë. Një sërë krizash në kohët e fundit kanë ndikuar ndjeshëm tregun botëror dhe natyrisht kanë patur efekte të konsiderueshme edhe në tregun e brendshëm. Gjatë gjithë kësaj kohe, ne jemi përpjekur dhe kemi arritur të qëndrojmë fort pranë partnerëve tanë, duke zgjeruar vazhdimisht gamën tonë të produkteve, duke ofruar më shumë se 15.000 artikuj, me më shumë se 120 marka, duke rritur me vetëdije stoqet tona dhe duke investuar në burime njerëzore. Ne këtë mënyrë sigurojmë të jemi zgjedhja kryesore për partnerët tanë në të gjithë Shqipërinë.

Synimi ynë është gjithmonë, ti shërbejmë biznesit tuaj në mënyrë të menjëhershme dhe optimale, përmes ofrimit të një game produktesh konkurruese, duke kërkuar në të njëjtën kohë ndershmëri dhe sinqeritet, për të siguruar partneritete afatgjata. Në strategjinë tonë të suksesit është shumë e rëndësishme pjesëmarrja e të gjithë departamenteve tona mbështetëse, të cilët me trajnimin e tyre të plotë janë gjithmonë pranë jush, për përgjigje dhe shërbim të menjëhershëm.

Dëshirojmë tui falenderojmë për besimin që keni treguar gjatë këtyre viteve ndaj nesh dhe përfitojmë nga rasti, për të mirëpritur të gjithë partnerët e rinj, që do të zgjedhin ti bashkohen familjes sonë të madhe të biznesit.

Ekipi KRAFT



Çmimet më të mira në treg

Ne arrijmë çmime të pakrahasueshme, duke siguruar produktet më cilësore



Disponueshmëri e lartë e mallrave

Kemi mbi 15.000 produkte të disponueshme dhe punojmë çdo ditë për ta shtuar gamën



Mbështetje eksperte

Specialistët tanë të shitjes janë gjithmonë pranë jush për të ofruar mbështetjen që ju nevojitet

ENGINEERED IN GERMANY MADE IN AUSTRIA / ITALIA



GERMANY
KÖTZ



AUSTRIA
OBDACH



ITALIA
REGGIO EMILIA

Kompania jonë ofron një gamë të gjerë të veglave të kopshtit dhe bujqësisë për të përmbushur nevojat e gjëra të përdoruesve. PREMIUM PRO ofron teknologji dhe performancë të përparuar për aplikime të vështira. COMFORT PRO ofron zgjidhje të rehatshme nga markat me te njohura. EASY PRO siguron pajisje të lehta dhe të fuqishme për të apasionuarit dhe mirëmbajtjen e kopshteve dhe lëndinave të mesme.

PREMIUM*pro*

Me veglat PREMIUM PRO, ju sigurisht do të përmirësoni cilësinë e punës në kopshtari dhe bujqësi. Duke ofruar teknologji dhe performancë të përparuar, veglat e kësaj game janë zgjidhja e duhur për kushte të ndryshme të punës. Nga kultivimi i tokës deri te kujdesi për kopshtin tuaj, veglat PREMIUM PRO ofrojnë një nivel të lartë të efikasitetit dhe lehtësisë së përdorimit. Ju merni vetëm më të mirën nga markat SOLO, FELCO, OREGON, SPERONI, GARDENA, KRAUSE, MINOS NIK, ANNOVI REVERBERI, etj.

- ✓ FUSHA BUJQËSORE DHE FERMA PRODHIMI
- ✓ KOPSHTË TË MËDHENJ DHE LËNDINA
- ✓ SIGURI E LARTË TEKNIKE
- ✓ TIPARE INOVATIVE DHE SMART
- ✓ TË QËNDRUESHËM PËR KËRKESA PROFESIONALE

COMFORT*pro*

Punë e thjeshtë, komode falë funksionalitetit më të lartë dhe paisjeve profesionale me veçori inovative. Me markat AL-KO, McCULLOCH, EINHELL, NAKAYAMA, KAMIKAZE, LAUNTOP, FITT, BORMANN, kjo është ajo që ju premtojmë në kategorinë tonë COMFORT PRO. Performanca ideale dhe qëndrueshmëria e provuar sigurojnë rezultate të shpejta pune që është mbresëlënëse.

- ✓ KOPSHTË TË MËDHENJ
- ✓ QËNDRUESHMËRI E LARTË
- ✓ TIPARE INOVATIVE
- ✓ PËR KËRKESA TË LARTA

EASY*pro*

Produkte për kopshte të mesme dhe të mëdha nga markat INGCO, FORCE, CELLFAST, VOREL, sepse kur ka shumë punë për të bërë, ajo që ka rëndësi është lehtësia e përdorimit, fleksibiliteti dhe funksionet shtesë, që e bëjnë cdo hap më të lehtë. Me produktet tona në kategorinë EASY PRO, jeni gjithmonë të mirëpërgatitur.

- ✓ KOPSHTË TË MESËM
- ✓ TË SHPEJTË DHE TË LEHTË
- ✓ FUNKSIONALITETE SHITESË
- ✓ PAISJE PËR TË APASIONUARIT

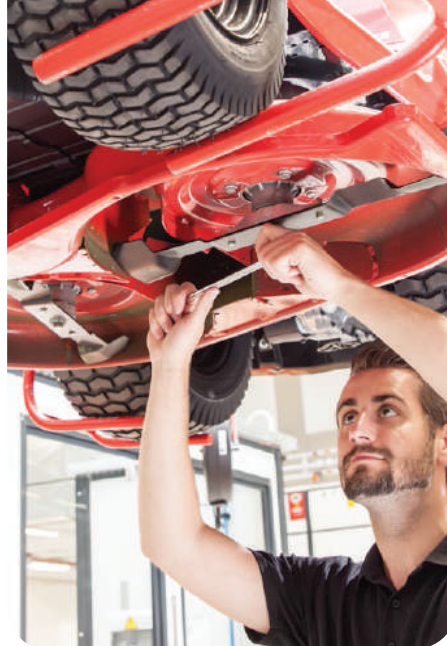



**Korrese bari dhe
Aksesore**



**Motokosa, Elektrokosa
dhe Aksesore**



**Krasitese Ligustrash,
Fryrese Gjethesh
dhe Motosharra**



**Freza, Turriela
dhe Sperkaese**



**Pompa Uji, Motopompa
dhe Gjeneratore**



**Lavazhe, Aspiratore
dhe Lavamoket**



**Gershere Krasitje,
Tuba uji, Karroca
dhe Rakorderi**











**Shkalle, Skela, Rafta
Metalike, Karrela dhe
Karroca Dore**



**Produkte Elektrike
dhe Hidraulike**

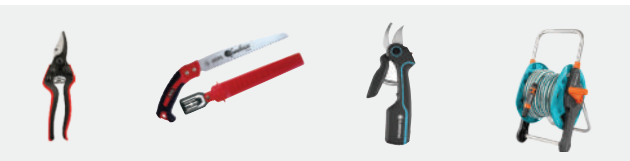

**Produkte Familjare
dhe Outdoor**

<p>Korrese bari me bateri Korrese bari elektrike Korrese bari me benzine Traktor me benzine Aksessore motosharre</p>	<p>Vaj motori Set aksesoresh Mbjatëse thike Set rotash Zgjatues kabulli</p>		<p>06-24 1</p>
<p>Motokosa me bateri Motokosa me benzine Aksessore elektrokose Vaj motokose Elektrokosa</p>	<p>Koke motokose Disk Motokose Fije Motokose Paisje mrojtesë Rrip per mbajtje</p>		<p>25-42 2</p>
<p>Krasitese ligustrash Krasitese elektrike Krasitese me benzine Shpata Zinxhire</p>	<p>Fryrese gjethesh me bateri Fryrese gjethesh elektrike Fryrese gjethesh me benzine Motosharre me bateri Elektrosharre</p>		<p>43-68 3</p>
<p>Traktor me nafte Freza toke me nafte Freze toke me benzine Aksessore freze Turrjele me benzine</p>	<p>Sperkatese me bateri Sperkatese me benzine Sperkatese mekanike Aksessore sperkatesesh Steka sperkatje</p>		<p>69-86 4</p>
<p>Pompe presioni Pompe volumetrike Pompe centrifugale Pompe zhytëse Pompe pusi</p>	<p>Motopompe me benzin Gjenerator me benzin Gjenerator silencioz Gjenerator me nafte Kuader elektrik</p>		<p>87-120 5</p>
<p>Lavazh me bateri Lavazhe familjar Lavazhe profesional Aspirator me bateri Aspirator elektrik</p>	<p>Pastruese me avull Lavamoket Aksessore per lavazhe dhe aspiratore Bombul shkume</p>		<p>121-135 6</p>
<p>Gershere me bateri Gershere mekanike Sharra krasitje Sharre teleskopike Gershere ligustrash</p>	<p>Karroce uji Zorra uji Rakorderi uji Aksessore vaditje Furca per larje</p>		<p>136-186 7</p>
<p>Shkalle familjare Shkalle profesionale Shkalle alumini Shkalle metalike Shkalle druri</p>	<p>Skela Karrela Karroce dore Rafte me kate Aksessore sinjalistike</p>		<p>187-210 8</p>
<p>Ndricues Spote Shirit LED Projektor Baladez</p>	<p>Priza/Adaptor Set dushi Rubinet Lavamani Mishelator Rakorderi hidraulike</p>		<p>211-272 9</p>
<p>Fisheke Celesa Doreze Dryn Kasaforte</p>	<p>Barbekju Elektroshtepiake Nderese rrobash Aksessore outdoor Set ndenje per kopesht</p>		<p>273-323 10</p>

Korrëse Robotike GARDENA

Korrëse bari inteligjente robotike, SILENO.

Kositëset robotike të barit GARDENA janë pajisje inteligjente që paraqesin Full Connect, AI-precize dhe Auto Weather & Terreni dhe janë më të qetat në klasën e tyre. SILENO-t tanë inteligjentë përfshijnë një pjesë të harduerit të quajtur Inteligjenca LONA™ që mundëson lokalizimin dhe navigimin e makinës suaj robotike të barit.* Zbuloni të ardhmen niveli i kujdesit inteligjent të lëndinës me gjurmimin e vendndodhjes, hartën e kopshtit, menaxhimin e zonave, mbrojtjen e zonës dhe shumë më shumë veçori që do të vijjnë.



Inteligjencë e përmirësuar me

LONA™
Intelligence



Lidhje direkte

Lidhje direkte me sistemin Inteligent Smart. Kujdesuni për kopshtin tuaj kudo që të jeni.

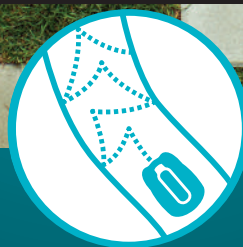

Prerje preçize

Roboti LONA™ mëson, skicon dhe përshtatet me kopshtin tuaj individual.





Prerje silencieze

Me i qeti në klasën e tij.



Të pandikuar nga moti dhe terreni

SILENO punon në çdo mot në shi, diell në kopësht të thjeshtë dhe kompleks.

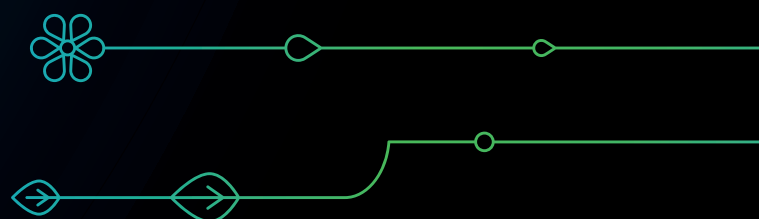

SILENO life

Korrësja silencieze për kopësht mbi 1500 m²



Roboti Inteligent LONA™
Mëson, skicon dhe përshtatet me kopshtin tuaj.

TASTIERA & EKRANI

Mund të bëhet edhe programimi direkt dhe tek roboti

KORRËS I QETË

Niveli i zhurmës vetëm 57 dB(A) i garantuar***

KORIDORE TË NGUSHTA

Falë dizajnit kompakt dhe kontrollit inteligjent mund të kalojë dhe në koridore të ngushta 60 cm

PJERRËSIA PRERJES

Deri në 35 %

PËRSHTATJA ME TERRENIN

Dy rrotat e integruara e bëjnë korrësen robotike të manovrueshëm dhe të qëndrueshëm në sipërfaqe të pabarabarta.

LEHTËSISHT I PASTRUESHËM ME TUB UJI

ZVENDOSJE E LEHTE E STACIONIT TË KARIKIMIT

Edhe në vendet më të vështira për tu arritur dhe jashtë zonës së korrjes.

PËRDORIMI I INSTALIMIT ASISTENT PËR TË CAKTUAR KOHËT E KORRJES

Shkruani madhësinë tuaj të lëndinës dhe kohën e korrjes dhe kjo automatikisht llogarit dhe gjeneron orarin.

PRERJA E PËRQËNDRUAR

E përqëndruar, korrje spirale e zonave me bar të lartë

SENSOR NDAJ NGRIRJES

SENSOR KONTROLLI

Rregullimi i shpeshtësisë së korrjes në varësi të shpejtësisë së rritjes së barit

TË PANDIKUAR NGA MOTI

Punon në çdo mot në shi, diell

Të disponueshme në



Aplikacioni Bluetooth® GARDENA

Kontroll i menjëhershëm deri në 10 m





Aplikacioni inteligjent GARDENA**
Kontroll i menjëhershëm nga kudo



Të dyja Aplikacionet unike GARDENA janë në dispozicion





S Për kopësht të vogël

		
Të dhëna	SILENO minimo	SILENO minimo
Per sipërfaqe	Deri ne 250 m ²	Deri ne 500 m ²
Aksesoret	150 m tel rrethues, 150 grepa, 4 ciftezuese, 5 bashkuese	150 m tel rrethues, 150 grepa, 4 ciftezuese, 5 bashkuese
Parametrat	-	-
Sistemi baterise	Bateri Lithium-ion	Bateri Lithium-ion
Pjerrësia maksimale	Deri ne 25%	Deri ne 25%
Rregullimi i lartësise se prerjes	20-45 mm	20-45 mm
Pesha	6.5 kg	6.5 kg
Siguria	Kod Pin	Kod Pin
Pastrimi me tub uji	•	•
Niveli i zhurmës, dB(A)	57 (dB)A	57 (dB)A
Prerje ne korridore te ngushta	•	•
Sensor ngrirje	•	•
Prerje e perqendruar	•	•
Koha e korrjes dhe karikimit	5.5 h	12.0 h
Kodi modelit me Bluetooth 	15201-32	15202-32
Kodi modelit Smart 	-	-
Çmimi	79.000	99.000

M Për kopësht mesatar

		
Të dhëna	SILENO life	SILENO life
Për sipërfaqe	Deri ne 1250 m ²	Deri ne 1500 m ²
Aksesorët	250 m tel rrethues, 300 grepa, 4 ciftezuese, 5 bashkuese	250 m tel rrethues, 300 grepa, 4 ciftezuese, 5 bashkuese
Parametrat	•	•
Sistemi baterisë	Bateri Lithium-ion	Bateri Lithium-ion
Pjerrësia maksimale	Deri ne 35%	Deri ne 35%
Rregullimi i lartësise se prerjes	20-50 mm	20-50 mm
Pesha	8.3 kg	8.3 kg
Siguria	Kod Pin, alarm	Kod Pin, alarm
Pastrimi me tub uji	•	•
Niveli i zhurmës, dB(A)	57 (dB)A	57 (dB)A
Prerje ne korridore te ngushta	•	•
Sensor ngrirje	•	•
Prerje e perqendruar	•	•
Koha e korrjes dhe karikimit	19.0 h	22.5 h
Kodi modelit me Bluetooth 	15103-32	15108-32
Kodi modelit Smart 	-	-
Çmimi	149.000	179.900

 Kontrolloni nëpërmjet aplikacionit GARDENA Bluetooth®. Pa pagesë për t'u shkarkuar, pa tarifa abonimi, i disponueshëm për smartphone dhe tablet. Kërkesat: smartphone ose tablet Android ose iOS me funksion Bluetooth®.

 Kontrolloni nëpërmjet aplikacionit inteligjent GARDENA**. Pa pagesë për t'u shkarkuar, pa tarifa abonimi, i disponueshëm për smartphone, tablet dhe ueb. Kërkesat: router Wi-Fi dhe akses në internet, smartphone, tablet ose kompjuter. *** Për maksimum. zona – vlera të përafërta, në varësi të formës së kopshut, lëndinës dhe kushteve mjedisore dhe moshës së baterisë.

AKSESORË SILENO



Garazhi i korreseve Robotike Sileno

Kodi 15020-20
Cmimi **26.500**



Kit per mirembajtjen, pastrimin e korreseve Robotike Sileno

Kodi 4091-20
Cmimi **2.100**



Kuti per mbrojtjen ndaj ftohtit te korreseve Robotike Sileno

Kodi 4056-20
Cmimi **2.350**

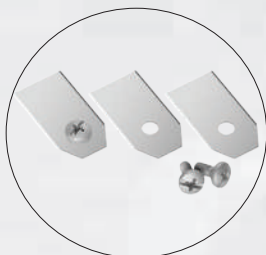

Thika prerje per korrese Robotike Sileno

Kodi 4087-20
Cmimi **2.690**



Kit konektoresh per lishje elektrike per korreseve Robotike Sileno

Kodi 4089-20
Cmimi **2.100**



Kunja per korreset Robotike Sileno

Kodi 4090-20
Cmimi **2.450**



Cante magazinimi per korreset Robotike Sileno

Kodi 4057-20
Cmimi **8.590**



Varese ne mur per korreset Robotike Sileno

Kodi 4045-60
Cmimi **8.590**



Furca per rrota per korreset Robotike Sileno

Kodi 4030-20
Cmimi **3.490**



Kit (Kunja + tel + lidhese shtrimi per korreset Robotike Sileno

Kodi 4059-60
Cmimi **3.690**



Tel shtrimi i perforcuar 50 m per korreset Robotike Sileno

Kodi 4058-60
Cmimi **4.690**



Tel shtrimi i perforcuar 150 m per korreset Robotike Sileno

Kodi 4088-60
Cmimi **11.900**

KORRESE BARI ME BATERI

- PowerMax 37/36V
- Motori 36V
- Me 2 bateri 18 V / 4.0 Ah
- Gjeresi prerje 37 cm
- Koshi 45 L

Kodi : 14638-20

ÇMIMI
59.900 Lek

MADE IN
GERMANY



KORRESE BARI ME BATERI

- 4757 Li SP
- Bateri 42 V / 7.5 Ah Lithium-Ion
- Me funksion te copezimit te barit dhe shkarkim anesore
- Gjeresi prerje 46 cm

Kodi : 127414

ÇMIMI
99.900 Lek

MADE IN
GERMANY



KORRESE BARI ME BATERI

- Moweo 42.0 Li
- Per lendina deri ne 400 m²
- Bateri 40 V / 5.0 Ah
- Motor pa karboncina
- Doreze ergonomike
- Gjeresi prerje 42 cm

Kodi : 119933

ÇMIMI
66.900 Lek

MADE IN
GERMANY



KORRESE BARI ME BATERI

- GE-CM 18/30 Li
- Me 1 bateri 18 V / 3.0 Ah
- Koshi: 25 L
- Gjeresi prerje: 30 cm
- Pa karboncina

Kodi : 34.131.55

ÇMIMI
19.500 Lek



1

2

3

4

5

6

7

8

9

10

KORRESE BARI ME BATERI

- | Motori 40 V, pa karboncina
- | Gjeresia e prerjes 51 cm
- | Me 2 bateri 20 V / 5.0 Ah
- | Koshi 60 lt
- | Shasi metalike

Kodi : LMLI20202

ÇMIMI
39.900 Lek



KORRESE BARI ME BATERI

- | Motori 40 V, pa karboncina
- | Gjeresia e prerjes 46 cm
- | Me 2 bateri 20 V / 5.0 Ah
- | Lartesia e prerjes e regullueshme 30-80 mm
- | Koshi 60 lt
- | Shasi metalike
- | Me 3 funksione

Kodi : LMLI20186

ÇMIMI
29.900 Lek



KORRESE BARI ME BATERI

- | Motori 40 V, pa karboncina
- | Gjeresia e prerjes 46 cm
- | Me 2 bateri 20 V / 5.0 Ah
- | Koshi 60 lt
- | Shasi metalike

Kodi : LMLI20182

ÇMIMI
27.900 Lek



KORRESE BARI ME BATERI

- | Motori 40 V
- | Koshi: 30 L
- | Gjeresi prerje : 34 cm
- | Lartesia e prerjes e regullueshme 20-70 mm
- | Vetem trup

Kodi : LMLI2014

ÇMIMI
11.900 Lek



GARDENA PowerMax Korrëse bari elektrike

Të fuqishme dhe ergonomike

Kositëset tona elektrike PowerMax™ ofrojnë mbulim optimal të barit dhe rezultate të shkëlqyera prerjeje falë motorit të fuqishëm PowerPlus dhe tehut dyfishhtë të përforcuar DuraEdge.



KORRESE BARI

- | PowerMax 42E
- | Koshi: 45 L
- | Gjeresi prerje : 42 cm
- | Fuqia 1800 W
- | Per sip. deri ne 800 m²
- Kodi : 5042-20**

ÇMIMI
26.900 Lek

MADE IN GERMANY



KORRESE BARI

- | PowerMax 37E
- | Koshi: 45 L
- | Gjeresi prerje : 37 cm
- | Fuqia 1600 W
- | Per sip. deri ne 500 m²
- Kodi : 14637-20**

ÇMIMI
24.900 Lek

MADE IN GERMANY



Dorezë ergonomike e harkuar

Përdorim i thjeshtë. Doreza **ErgoTec** siguron fleksibilitet gjatë punës dhe mundëson përdorimin e korrëses në një pozicion natyral të dorës.



Motor PowerPlus

Motori me fuqi të lartë dhe moment të lartë rrotullimi që jep rezultate precize prerjeje. Veçanërisht efikase për një jetë shumë të gjatë shërbimi.

Më shumë bar i mbledhur në koshin e pasëm falë qarkullimit të mirë të ajrit, që do të thotë zbrazje më e rrallë dhe kursim kohe.



KORRESE BARI

- | PowerMax 1200/32
- | Koshi: 30 L
- | Gjeresi prerje : 32 cm
- | Fuqia 1200 W
- | Per sip. deri ne 300 m²
- Kodi : 14633-20

ÇMIMI
14.900 Lek



KORRESE BARI

- | PowerMax 1100/32
- | Koshi: 29 L
- | Gjeresi prerje : 32 cm
- | Fuqia 1100 W
- | Per sip. deri ne 250 m²
- Kodi : 5031-20

ÇMIMI
13.500 Lek



KORRESE BARI

- | 3.82 SE
- | Koshi: 37 L
- | Gjeresi prerje : 38 cm
- | Fuqia 1400 W
- | Per sip. deri ne 550 m²
- Kodi : 112856

ÇMIMI
12.900 Lek



KORRESE

- | 3.22 SE
- | Koshi: 30 L
- | Gjeresi prerje : 32 cm
- | Fuqia 1000 W
- | Per sip. deri ne 250 m²
- Kodi : 112805

ÇMIMI
9.900 Lek



KORRESE BARI



- | Motor me induksion
- | Koshi: 50 L
- | Gjeresi prerje : 38 cm
- | Fuqia 1600 W
- Kodi : LM383

ÇMIMI
14.900 Lek



KORRESE BARI



- | Koshi: 45 L
- | Gjeresi prerje : 38 cm
- | Fuqia 1600 W
- | Lartesia e prerjes: 28 / 48 / 68mm
- Kodi : LM385

ÇMIMI
9.900 Lek



KORRESE BARI



- | Koshi: 28 L
- | Gjeresi prerje : 32 cm
- | Fuqia 1200 W
- | Per sip. deri ne 300 m²
- Kodi : LM321

ÇMIMI
7.500 Lek



KORRESE BARI



- | Koshi: 30 L
- | Gjeresi prerje : 32 cm
- | Fuqia 1000 W
- | Per sip. deri ne 300 m²
- Kodi : 34.002.57

ÇMIMI
7.900 Lek



1
2
3
4
5
6
7
8
9
10



KORRESE BARI ELEKTRIKE

- | Gjeresi prerje : 33cm
- | Lartesia: 20-60mm
- | Koshi : 30 Lt
- | Fuqia : 1300 W
- Kodi : WEN3205

CMIMI
7.500 Lek



KORRESE BARI ELEKTRIKE

- | Gjeresi prerje : 32cm
- | Lartesia: 25-65mm
- | Koshi : 30 Lt
- | Fuqia : 1200 W
- Kodi : WEN3201

CMIMI
6.500 Lek



NGJESHES TOKE

- | Gjeresia e punes: 57 cm
- | Volumi i rrullit: 46 L
- | Pesha bosh: 10.5 kg

Kodi : 34.153.02

CMIMI
9.500 Lek



KORRESE BARI MANUALE

- | 28.1 HM Easy
- | Per lendina deri ne 250 m²
- | Gjeresia e prerjes 28 cm
- | Lartesia e prerjes : 14 - 35 mm
- | Rotat 128 mm

Kodi 113864

CMIMI
9.900 Lek



KORRESE BARI ME BENZINE

- | Rezultatet optimale te korrjes dhe kapjes fale formes aerodinamike te karkases
- | Doreza e përparme per transport komod
- | Karkase celiku me cilesi te larte
- | Motor OHV per ndezje te shpejte
- | Rregullim i lartesisë qendrore te prerjes



HONDA

KORRESE BARI ME BENZINE

solo
by AL-KO

- | 5231 SP-H
- | Gjeresi prerje 51 cm
- | 3.2 kW HONDA GCVx 170
- | Per lendina deri ne 1.800 m²
- | Koshi 71 L
- | Me rrota aktive
- | Shkarkimi anesor i integruar

Kodi 127605



CMIMI
99.000 Lek

KORRESE BARI ME BENZINE

AL-KO

- | PREMIUM 520 VS-B
- | Gjeresi prerje 51 cm
- | 2.6 kW B&S Series 675EXi
- | Per lendina deri ne 1.800 m²
- | Koshi 70 L
- | Me rrota aktive
- | Shkarkimi anesor i integruar

Kodi 119949



CMIMI
79.000 Lek



**KORRESE BARI
ME BENZINE**

- | Motori 196 cc
- | Gjeresi prerje 56 cm
- | 6 pozicione prerje 25-75 mm
- | Koshi 65 L
- | 4 ne 1 funksione
- | Me shpejtesi te ndryshueshme
- | Me rrota aktive

Kodi PM5860

**CMIMI
49.900 Lek**



**KORRESE BARI
ME BENZINE**

- | Motori 196 cc
- | Gjeresi prerje 53 cm
- | 6 pozicione prerje 25-75 mm
- | Koshi 65 L
- | Me shpejtesi te ndryshueshme
- | Me rrota aktive

21" THIKA

Kodi PM5810

**CMIMI
45.900 Lek**



**KORRESE BARI
ME BENZINE**

- | Motori 170 cc
- | Gjeresi prerje 51 cm
- | 6 pozicione prerje 25-75 mm
- | Me shpejtesi te ndrvshueshme
- | Koshi 65 L

Kodi PM5310

**CMIMI
39.900 Lek**



KORRESE BARI ME BENZINE

KORRESE BARI ME BENZINE

AL-KO

- | Easy 5.10 SP-S
- | Gjeresi prerje 51 cm
- | Per lendina deri ne 1.800 m²
- | Koshi 60 L
- | Me rrota aktive
- | Shkarkimi anesor i integruar

4 IN ONE function

Kodi 113796



CMIMI
45.900 Lek

EASY



KORRESE BARI ME BENZINE

AL-KO

- | Easy 4.60 SP-S
- | Gjeresi prerje 46 cm
- | Per lendina deri ne 1.400m²
- | Koshi 60 L
- | Lartesia e prerjes : 30 - 75 mm
- | Me rrota aktive

Kodi 113795



CMIMI
36.900 Lek

EASY



KORRESE BARI ME BENZINE

AL-KO

- | Easy 4.2 P-S
- | Gjeresi prerje 42 cm
- | Per lendina deri ne 800 m²
- | Koshi 50 L
- | Lartesia e prerjes : 30 - 75 mm

Kodi 113794

CMIMI
29.900 Lek

EASY



KORRESE BARI ME BENZINE

Einhell

- | Motori 170 cm³
- | Fuqja 2.7 kW
- | Gjeresi prerje 51 cm
- | Koshi 70 L



4in1
- MOWING
- MULCHING
- SIDE DISCHARGE
- CATCHING



NDEZJE
ELEKTRIKE

Kodi 34.048.70

CMIMI
36.900 Lek



KORRESE BARI

LAUNTOP

- | Gjeresi prerje : 50 cm
- | Me 7 nivele prerje
- | Koshi : 70 L
- | Fuqia : 175 cc
- | Me rrota aktive



Kodi : LV50Z4

CMIMI
29.900 Lek



KORRESE BARI

LAUNTOP

- | Gjeresi prerje : 46 cm
- | Lartesia e prerjes : 25 - 75 mm
- | Me 6 nivele prerje
- | Fuqia: 150 cc
- | Koshi 70 Lt



Kodi : LV46Z52

CMIMI
26.900 Lek



KORRESE BARI

LAUNTOP

- | Gjeresi prerje : 41 cm
- | Koshi : 55 L
- | Lartesia e prerjes : 25 - 75 mm
- | Me 6 nivele prerje
- | Fuqia : 150 cc
- | 4-Kohë OHV EURO 5

Kodi : LV43T1

CMIMI
19.900 Lek



KORRESE BARI

FORCE
MACHINERY - TOOLS

- | Gjeresi prerje 51 cm
- | Koshi : 60 L
- | Fuqia : 196cc
- | Me rrota aktive



Kodi : WX-SM5104B

CMIMI
27.900 Lek

*3 në 1 - Prerje, bluarje,
mbledhje, shkarkim anësor*



KORRESE BARI



- | Gjeresi prerje 51 cm
 - | Me 7 nivele prerje
 - | Koshi : 65 L
 - | Fuqia : 196cc
 - | Me rrota aktive
- Kodi : GLM196200



CMIMI
28.900 Lek



KORRESE BARI



- | Gjeresi prerje 51 cm
 - | Me 7 nivele prerje
 - | Koshi : 60 L
 - | Fuqia : 196cc
 - | Me rrota aktive
- Kodi : GLM196201



CMIMI
27.900 Lek



KORRESE BARI



- | Gjeresi prerje 51 cm
 - | Me 5 nivele prerje
 - | Koshi : 65 L
 - | Fuqia : 171cc
- Kodi : GLM171200



3.0kW/171cc

510mm(20")

CMIMI
25.900 Lek



Self-propelled



KORRESE BARI



- | Gjeresi prerje : 46 cm
 - | Me 7 nivele prerje
 - | Koshi : 55 L
 - | Fuqia : 141cc
- Kodi GLM141180

CMIMI
19.900 Lek



TRAKTOR SOLO



- | Model T15-93.7 HD-A
- | Traktor kompakt
- | Gjeresi prerje 93 cm
- | Motor i fuqishem 7.7 kW
- | Koshi 220 Lt
- | Per lendina deri ne 6.000 m²

Kodi 127417

CMIMI
429.000 Lek



TRAKTOR SOLO



- | Model T18-105.4 HD V2
- | Gjeresia e prerjes 105 cm
- | Motor i fuqishem 9.1 Kw
- | Koshi 310 Lt
- | Perdorim i lehte
- | Per lendina deri ne 8.000 m²

Kodi 127707

CMIMI
590.000 Lek



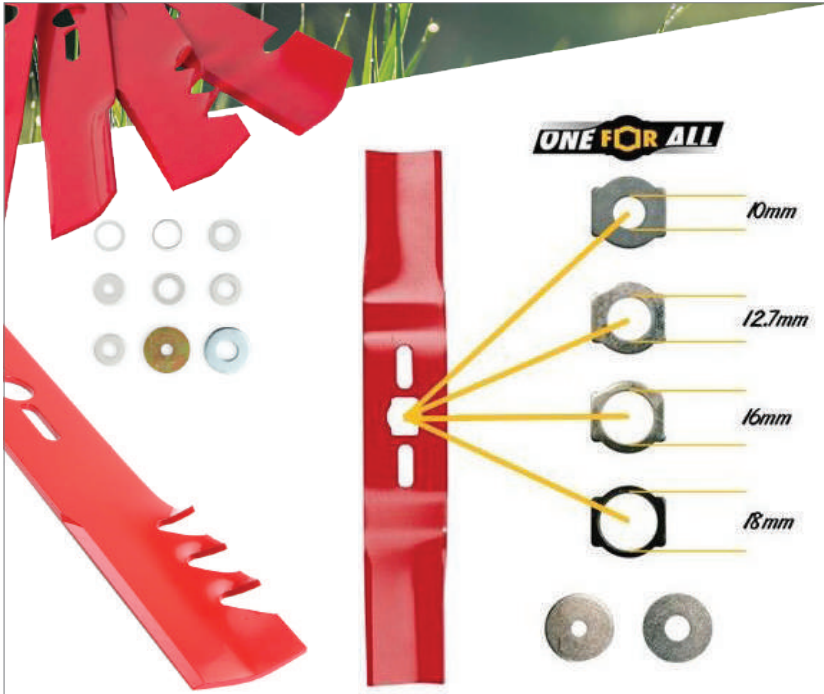

Thikat universale ONE FOR ALL përshtaten me të gjitha llojet e korrëseve të barit me benzinë, MTD, Alpina, Stiga, Stihl, Husqvarna, Einhell, Force.

Thika universale per korrëse bari

Kodi	Madhesia	Çmimi
69-248-0	40 cm	2.200
69-249-0	42 cm	2.290
69-258-0	45 cm	2.390
69-259-0	48 cm	2.490
69-260-0	50 cm	2.590
69-261-0	52 cm	2.690

GARDENA

4080-20	4081-20	4016-20	4017-20
			
Çmimi 2.990	Çmimi 2.990	Çmimi 3.290	Çmimi 3.590
Thike rezerve per korrëse	Thike rezerve per korrëse	Thike rezerve per korrëse	Thike rezerve per korrëse
Gjatesia 32 cm	Gjatesia 36 cm	Gjatesia 37 cm	Gjatesia 42 cm

AL-KO

440125	474260	474544	492242
			
Çmimi 4.690	Çmimi 2.900	Çmimi 3.500	Çmimi 2.990
Thike rezerve per korrëse	Thike rezerve per korrëse	Thike rezerve per korrëse	Thike rezerve per korrëse
Classic 4.66 SP-A, 46 cm	Classic 3.22 SE, 32 cm	Classic 3.82 SE, 38 cm	Easy 4.2 P-S, 42 cm
492208	492209	461742	461742
			
Çmimi 3.950	Çmimi 3.990	Çmimi 4.900	Çmimi 4.900
Thike rezerve per korrëse	Thike rezerve per korrëse	Thike per traktor	Thike per traktor
Easy 4.6 SP-S, 46 cm	Easy 5.10 SP-S, 51cm	Majtas	Djahtas

1
2
3
4
5
6
7
8
9
10

LM321-SP-30 	LM383-SP-18 	LM385-SP-30 	LMLI2014-SP-22 
 Çmimi 590	 Çmimi 990	 Çmimi 990	 Çmimi 1.150
Thike rezerve per korrese LM321	Thike rezerve per korrese LM383	Thike rezerve per korrese Gjatesia 38 cm	Thike rezerve per korrese Gjatesia 34 cm
GLM141181-SP-B3 	GLM196201-SP-B3 	LM383-SP-22 	34.070.00 
 Çmimi 1.390	 Çmimi 1.590	 Çmimi 1.990	 Çmimi 1.890
Thike rezerve per korrese GLM14118, 46 cm	Thike rezerve per korrese GLM196201, 51 cm	Kosh rezerve per korresen LM383	Pompe Mekanike Benzin&vaj Per korrese me depozite 1.6Lt
Set rrotash 6" dhe 8" 	Set rrotash per LM385 	GLM196201-SP-B15 	LM383-SP-7 
		 Çmimi 1.590	 Çmimi 190
Kodi Cmimi	Kodi Te dhena Cmimi	Rrote komplet 8" Per korresen GLM196201	Mbrojtese rrote LM383
GLM141181-SP-B12 990 GLM141181-SP-B29 1.250	LM385-SP-34 prapa 690 LM385-SP-36 perpara 590	577616435 	Zgjatues kabulli IP44 Me prize spine dhe kapak 
577616401 	577616821 	 Çmimi 450	
 Vaj SAE30 me 4 kohe 0.6 L	 Shiringe per depozite Vaj	 Stabilizator karburanti 200ml 2T/4T	Kodi Peshkrimi Cmimi
			5970010 10 m 1.490 5970020 20 m 2.390 5970030 30 m 2.790 5970035 35 m 2.990



**MOTOKOSA DHE
ELEKTROKOSA**

Einhell

MOTOKOSE ME BATERI

- | Motokose me bateri AGILLO 18/200
- | Nr rrotullimeve: 7.500 min-1
- | Gjeresia prerjes (Disk): 20 cm
- | Gjeresia prerjes (fije): 30 cm
- | Sistemi Spindle-Lock-System per te ndryshuar lehtesisht nga fije ne disk
- | Vetem trup

Kodi 34.113.10

**CMIMI
11.900 Lek**

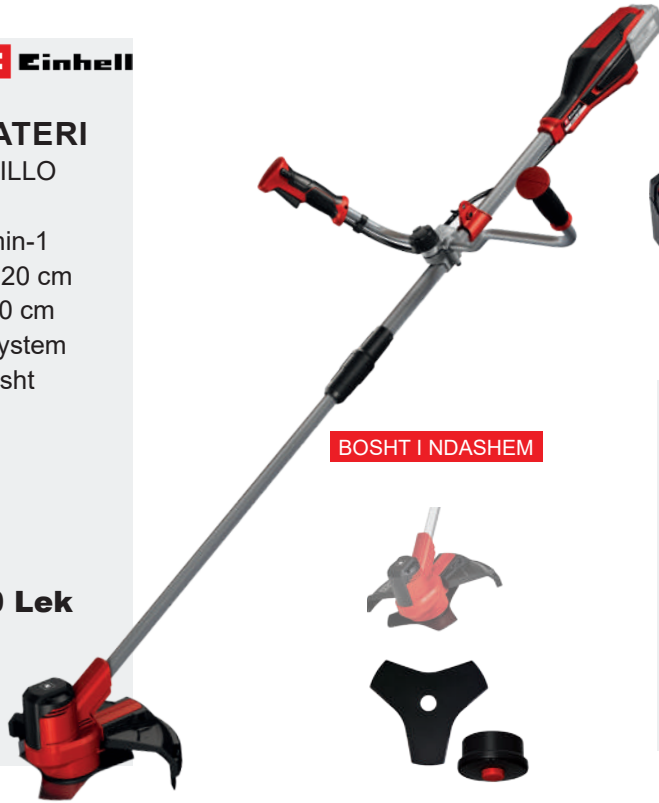

POWER X-CHANGE



BOSHT I NDASHEM



Einhell

STARTER KIT

- | Set me bateri 18 V / 4.0 + karikues

Kodi 45.120.42

**CMIMI
7.500 Lek**

INGCCO
Professional Tools Built Stronger

MOTOKOSE ME BATERI 40 V

- | Nr rrotullimeve 75000 / min
- | Gjatesia prerjes 330 mm
- | Me 2 bateri 20 V / 4.0 Ah
- | Pajisur me koke me fije dhe top me fije dhe disk
- | Pa karboncina

Kodi CSTLI20252

**CMIMI
21.900Lek**

P20S BL MOTOR



INGCCO
Professional Tools Built Stronger

MOTOKOSE ME BATERI 40 V

- | Nr rrotullimeve 75000 / min
- | Gjatesia prerjes 330 mm
- | Pa karboncina
- | Pajisur me koke me fije dhe top me fije dhe disk
- | Vetem trup

Kodi CSTLI20018

**CMIMI
14.500 Lek**

P20S BL MOTOR



**MOTOKOSE
ME BENZINE**

- | BC 500 B
- | Motor me 2-kohe
- | Fuqia 50 cc / 1.9 kW
- | Gjeresia prerjes 41 cm fije / 25 cm teh
- | Koka e fijos automatike
- | E perfshire mbajtes rripi

Kodi 113785

**CMIMI
26.900 Lek**



MADE IN GERMANY



AL-KO
QUALITY FOR LIFE

**MOTOKOSE
ME BENZINE**

- | BC 400 B
- | Motor me 2-kohe
- | Fuqia 39.8 cc / 1.25 kW
- | Gjeresia prerjes 41 cm fije / 25 cm teh
- | Koka e fijos automatike
- | E perfshire mbajtes rripi

Kodi 113784

**CMIMI
24.900 Lek**



MADE IN GERMANY



**MOTOKOSE
ME BENZINE**

- | BC 330 B
- | Motor me 2-kohe
- | Fuqia 32.6 cc / 0.9 kW
- | Gjeresia prerjes 41 cm fije / 25 cm teh
- | Koka e fijos automatike
- | E perfshire mbajtes rripi

Kodi 113758

**CMIMI
22.900 Lek**

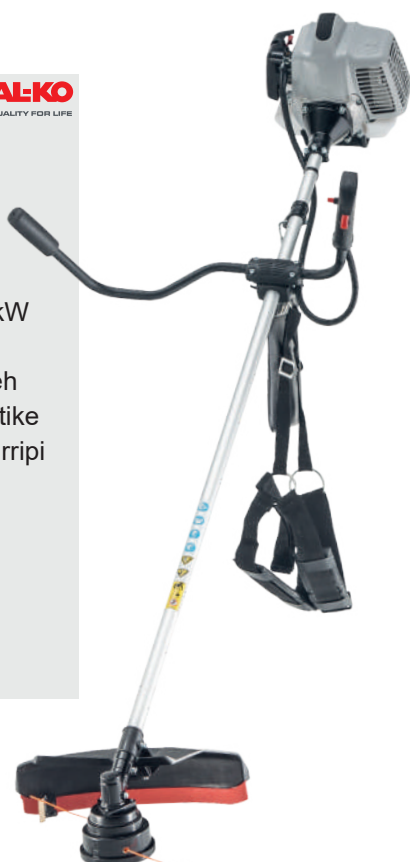

MADE IN GERMANY



AL-KO
QUALITY FOR LIFE

**MOTOKOSE
ME BENZINE**

- | BC 223 B
- | Motor me 2-kohe
- | Fuqia 22.5 cc / 0.7 kW
- | Gjeresia prerjes 41 cm fije / 25 cm teh
- | Koka e fijos automatike
- | E perfshire mbajtes rripi

Kodi 113692

**CMIMI
19.900 Lek**

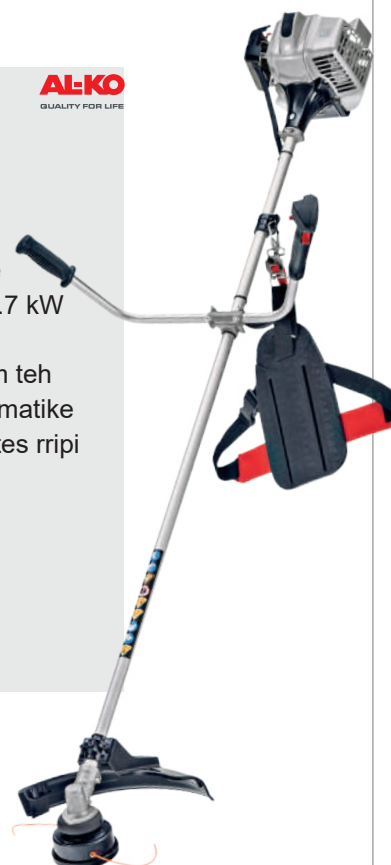

MADE IN GERMANY



**MOTOKOSE
ME BENZINE**

- | Fuqia 62 cc / 3.0 Hp
- | Aksi nje pjesesh 28 mm me sistem antidridhje
- | Timoni ergonomik forma U
- | Depozita karburantit 900 ml
- | Perfshin koken gjysme automatike dhe disk

Kodi PB6310

CMIMI
22.500 Lek



**MOTOKOSE
ME BENZINE**

- | Fuqia 62 cc / 3.0 Hp
- | Timoni ergonomik U
- | Depozita karburantit 900 ml
- | Perfshin koken gjysme automatike, diskun 3 T

Kodi PB6210

CMIMI
16.900 Lek



**MOTOKOSE
ME BENZINE**

- | Fuqia 52 cc
- | Timoni ergonomik forma U
- | Depozita karburantit 900 ml
- | Perfshin koken gjysme automatike, diskun 3 T.
- | Koka e fijos automatike

Kodi PB5221

CMIMI
14.500 Lek



**MOTOKOSE
ME BENZINE**

- | Motori 51.7 cc
- | Fuqia 2.3Hp
- | Sistem Antivibrimi
- | Timoni ergonomik forma U
- | Perfshin koken gjysme automatike dhe disk

Kodi PB5600

CMIMI
22.500 Lek



ERE

**MOTOKOSE
ME BENZINE**

- | Model B33-B
- | Motori 33 cc
- | Fuqia 0.9 kW
- | Disk me fije dhe koke
- | Gjeresi prerje 42 cm

Kodi 967057401

CMIMI
13.900 Lek

MCCULLOCH

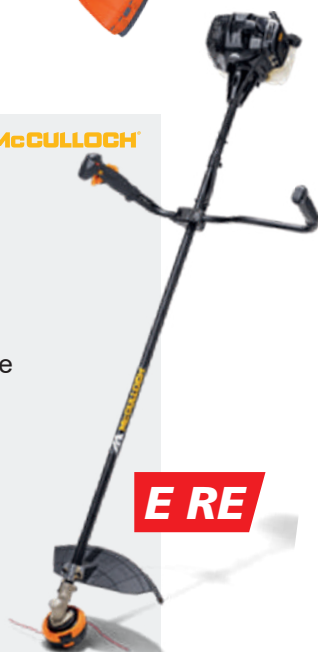

ERE

**MOTOKOSE
ME BENZINE**

- | Model B43BT
- | Motori 43 cc
- | Fuqia 1.25 kW
- | Disk me fije dhe koke
- | Gjeresi prerje 52 cm

Kodi 967683401

CMIMI
14.900 Lek

MCCULLOCH

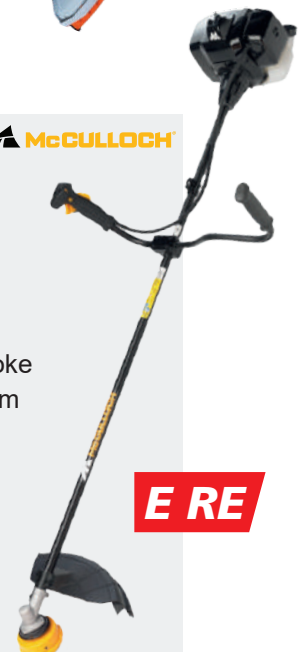

ERE

PROLINE

**MOTOKOSE
ME BENZINE**

- | Motori 51.7 cc
- | Motori 1E44F
- | Fuqia 1.4 kW
- | Pajisur me disk
- | Koke me dopio fije 2.7 mm

Kodi CGTB52

CMIMI
13.500 Lek



PROLINE

**MOTOKOSE
ME BENZINE**

- | Motori 42.7 cc
- | Motori 1E40F
- | Fuqia 1.25 kW
- | Pajisur me disk
- | Koke me dopio fije 2.4 mm

Kodi CGTB43

CMIMI
12.900 Lek



PROLINE

**MOTOKOSE
ME BENZINE**

- | Motori 32.6 cc
- | Motori 1E36F
- | Fuqia 0.9 kW
- | Pajisur me disk
- | Koke me dopio fije 2.4 mm

Kodi CGTB33

CMIMI
12.500 Lek



PROLINE

**MOTOKOSE
ME BENZINE**

- | Motori 25.4 cc
- | Motori 1E34F
- | Fuqia 0.75 kW
- | Pajisur me disk
- | Koke me dopio fije 2.4 mm

Kodi CGTB26

CMIMI
12.200 Lek



1
2
3
4
5
6
7
8
9
10

INGCO
Professional Tools Made Affordable

MOTOKOSE ME BENZINE

- | Motori 62 cc
- | Shpejtesia max 9000 rpm
- | Gjeresia prerjes 480 mm
- | Pajisur me koke me fije dhe disk me 3 dhembe

Kodi GBC5624421

CMIMI
14.900 Lek



Trup i ndashem



INGCO
Professional Tools Made Affordable

MOTOKOSE ME BENZINE

- | Motori 52 cc
- | Shpejtesia max 9000 rpm
- | Gjeresia prerjes 420 mm
- | Pajisur me koke me fije dhe disk me 3 dhembe

Kodi GBC5524421

CMIMI
14.500 Lek

52cc 1.4kW



Trup i ndashem



INGCO
Professional Tools Made Affordable

MOTOKOSE ME BENZINE

- | Motori 42.7 cc
- | Shpejtesia max 9000 rpm
- | Gjeresia prerjes 420 mm
- | Pajisur me koke me fije dhe disk me 3 dhembe

Kodi GBC5434421

CMIMI
13.500 Lek



Trup i ndashem



INGCO
Professional Tools Made Affordable

MOTOKOSE ME BENZINE

- | Motori me 4 kohe 31 cc
- | Shpejtesia max 9300 rpm
- | Gjeresia prerjes 480 mm
- | Pajisur me koke me fije dhe disk me 3 dhembe

Kodi GBC53144141

CMIMI
18.500 Lek



Motor me 4 kohe



1
2
3
4
5
6
7
8
9
10

**MOTOKOSE
ME BENZINE**

- | Fuqia 52 cc
- | Me disk
- | 40 Piston
- | Plastic Starter

Kodi WX-CG520A

CMIMI
9.900 Lek

E RE



**MOTOKOSE
MULTIFUNKSIONALE**

- | Model BS33-PS
- | Motori 33 cc
- | Fuqia 0.9 kW
- | Krasitese ligustrash
- | Sharre krasitese

Kodi 967865601

CMIMI
19.900 Lek

E RE



**MOTOKOSE
MULTIFUNKSIONALE**

- | Motori 32.6 cc
- | Motori 1E36F
- | Fuqia 0.9 kW
- | Shpate 25 cm
- | Zinxhir 3/8"

Kodi MT330

CMIMI
21.900 Lek



**KRASITese
MULIFUNKSIONALE**

- | Motori 25.4 cc
- | Motori me 2-kohe
- | Fuqia 0.7 kW
- | Krasitese ligustrash
- | Sharre krasitese

Kodi WX-CG300

CMIMI
14.900 Lek



ELEKTROKOSE ME BATERI

- | Ana me e bukur e kujdesit ndaj kopshteve
- | Doreza teleskopike e rregullueshme lejon të përshtatet me lartesine e trupit tuaj.
- | Tregues LED i baterise gjithmonë do ta dini se sa kohë mund të vazhdoni të punoni
- | Prerje e sakte, precize dhe e paster.



GARDENA

ELEKTROKOSE ME BATERI

- | EasyCut 23/18V
- | Me 1 bateri 18 V / 2.0 Ah
- | Doreze teleskopike e rregullueshme

Kodi 14700-20

ÇMIMI
14.900 Lek

MADE IN GERMANY



INGCO
Professional Tools Made in Ukraine

ELEKTROKOSE ME BATERI

- | Tensioni 20 V
- | Nr rrotullimeve bosh 300 mm
- | Silencioze
- | Gjeresia e prerjes 300 mm
- | Fija (Twisted) 1.6 mm x 5 m

Kodi CGTLI20301

ÇMIMI
8.500 Lek



GARDENA

ELEKTROKOSE

- | SmallCut 550
- | Fuqia 550 W
- | Gjeresia e prerjes 28 cm
- | Koke me fije tap&go
- | Doreze teleskopike 90-120 mm

Kodi 9872-20

ÇMIMI
9.900 Lek

MADE IN GERMANY



GARDENA

ELEKTROKOSE

- | SmallCut 400
- | Fuqia 450 W
- | Gjeresia e prerjes 25 cm
- | Koke me fije tap&go 1.4 mm
- | Doreze teleskopike 90-120 mm

Kodi 9870-20

ÇMIMI
8.900 Lek

MADE IN GERMANY





ELEKTROKOSE

- | SmallCut 300
- | Fuqia 300 W
- | Gjeresia e prerjes 23 cm
- | Koke me fije tap&go 1.4 mm

Kodi 9805-20

ÇMIMI
6.500 Lek



ELEKTROKOSE

- | GTE 450
- | Fuqia 450 W
- | Gjeresia e prerjes 30 cm
- | Koka e fijos automatike

Kodi 112929

ÇMIMI
9.990 Lek



ELEKTROKOSE

- | GTE 350
- | Fuqia 350 W
- | Gjeresia e prerjes 25 cm
- | Koka e fijos automatike

Kodi 112928

ÇMIMI
8.900 Lek



ELEKTROKOSE

- | GC-ET 4530 Set
- | Fuqia 450 W
- | Gjeresia e prerjes 30 cm
- | Koke me fije tap&go
- | Doreze teleskopike 90-120 mm

Kodi 34.020.22

ÇMIMI
7.500 Lek



ELEKTROKOSE

- | GT3512
- | Fuqia 350 W
- | Gjeresia e prerjes 25 cm
- | Bosht teleskopik 45-270 mm

Kodi GT3512

ÇMIMI
3.900 Lek



ELEKTROKOSE

- | WXM3502
- | Fuqia 350 W
- | Gjeresia e prerjes 25 cm
- | Koke me fije tap&go 1.2 mm
- | Doreze teleskopike 90-120 mm

Kodi WXM3502

ÇMIMI
2.900 Lek



1
2
3
4
5
6
7
8
9
10



5301831



Çmimi
790

Graso per motokosa

125 ml

577616407



Çmimi
150

Vaj mishele 2T

100 ml

LB1000



Çmimi
330

Vaj i kuq

100 ml

LB1050



Çmimi
1.650

Vaj Mishelle i kuq

2T me dozim 1Lt

OIL-RED



Çmimi
850

Vaj Mishele i kuq me dozim

2T, 1Lt

Fije elektokose GARDENA



Kodi	Gjatesia	Çmimi
5306-20	Per smallcut 300	1.350
5307-20	Easycut 400, powercut 450	1.350

ALS1601



Çmimi
630

Set me 2 Koka me fije per elektokosa

1.6 mm x 5 m

577616433



Çmimi
1.450

Kit aksesoresh motokosash

Vaj 2T 100ml+syze+bidonperzjerje+fije

PB320



Çmimi
950

Koke motokose

Universale

PB340



Çmimi
850

Koke motokose me fije

Gjeresia e prerjes 35cm

























PB300



Çmimi
890

Koke alumini me 4 fije

35 cm

N8	577615901	577615902	1
	 IRI	 IRI	2
			3
Çmimi 1.590	Çmimi 1.450	Çmimi 1.450	4
Koke motokose	Kokë motokosash automatike	Kokë motokosash automatike	5
Me zinxhir	P25	P35	6
N7	PB310	ALS25405	7
			8
			9
Çmimi 650	Çmimi 1.250	Çmimi 1.090	10
Koke alumini me 4 fije	Koke automatike me 2 fije	Koke me fije per motokose	
Najloni	M10x1.25	Diametri 2.5 mm	
N4	N2	N9	
			
			
Çmimi 790	Çmimi 650	Çmimi 1.200	
Koke per fije najloni plastike	Koke per fije najloni plastike	Koke per fije najloni plastike	
Me insert metalik	Plastike	Me perforcim metalik	
89402	89422	Fije motokose profil yll	
			
			
Çmimi 79	Çmimi 99		
Fije motokose profil te rrumbullaket	Fije motokose profil yll	Kodi	Te dhena
1.6mm x 10m	1.6mm x 15m	89423	2.0 mm x 15m
		89424	2.4 mm x 15m
			Çmimi
			129
			165

Fije motokosash TERRAMAX Blister

OREGON



Fije motokosash TERRAMAX Blister

OREGON



ERE

636775

OREGON



ERE

Çmimi
2.390

Kodi	Te dhena	Çmimi
636779	2.7mm, 56m	2.390
636778	3.0mm, 44m	2.390

Kodi	Te dhena	Çmimi
636777	3.5mm, 36m	2.390
636776	4.0mm, 26m	2.390

Kodi	Te dhena	Çmimi
636775	4.5mm, 17m	2.390

Fije motokosash TERRAMAX Top

OREGON



ERE

Fije motokosash TERRAMAX Top

OREGON



ERE

636770

OREGON



ERE

Çmimi
8.900

Kodi	Te dhena	Çmimi
636774	2.7mm, 280m	8.900
636773	3.0mm, 220m	8.900

Kodi	Te dhena	Çmimi
636772	3.5mm, 183m	8.900
636771	4.0mm, 128m	8.900

Kodi	Te dhena	Çmimi
636770	4.5mm, 111m	8.900

Fije per motokosa me blister
Round twist e zeze

SINT



ERE



Fije per motokosa me blister
Round twist e zeze

SINT



ERE



Fije per motokosa me blister
Round twist e zeze

SINT



ERE



Kodi	Te dhena	Çmimi
VTT3050	3.00 x 50m	1.290
VTT3537	3.50 x 37m	1.290

Kodi	Te dhena	Çmimi
VTT4028	4.00 x 28m	1.290
VTT4324	4.30 x 24m	1.290

Kodi	Te dhena	Çmimi
VTT4721	4.70 x 21m	1.290
VTT5019	5.00 x 19m	1.290
VTT5317	5.30 x 17m	1.290

Fije per motokosa ne karrukull me
profil Twist Vortex

SINT



ERE



Fije per motokosa ne karrukull me
profil Twist Vortex

SINT



ERE



Fije per motokosa me blister
Round twist e zeze

NAKAYAMA



Kodi	Te dhena	Çmimi
VTT499	4.00 x 99m	2.990
VTT485	4.30 x 85m	2.990
VTT480	4.50 x 80m	2.990

Kodi	Te dhena	Çmimi
VTT477	4.70 x 77m	2.990
VTT570	5.00 x 70m	2.990
VTT564	5.30 x 64m	2.990

Kodi	Te dhena	Çmimi
NC1041	4.00mm-32m	1.290
NC1042	4.30mm-27m	1.290
NC1043	4.70mm-23m	1.290



Fije motokose me blister profil katror

Kodi	Trashesia	Cmimi
NC1013	3.0 x 48 m	1.590
NC1014	3.5 x 35 m	1.590
NC1015	4.0 x 24 m	1.590



Fije motokose me blister profil rrethor

Kodi	Trashesia	Cmimi
NC1008	3.0 x 56 m	1.490
NC1009	3.5 x 41 m	1.490
NC1010	4.0 x 32 m	1.490



Fije motokose me blister profil Twist

Kodi	Trashesia	Cmimi
NC1000	3.0 x 50 m	1.490
NC1001	3.5 x 36 m	1.490
NC1002	4.0 x 28 m	1.490
NC1003	4.3 x 23 m	1.490
NC1004	4.7 x 19 m	1.490



Fije motokose me karrukull profil katror

Kodi	Trashesia	Cmimi
NC1016	3.0 x 140 m	4.590
NC1017	3.5 x 103 m	4.590
NC1018	4.0 x 80 m	4.590



Fije motokose me karrukull profil Twist

Kodi	Trashesia	Cmimi
NC1005	4.0 x 80 m	4.200
NC1006	4.3 x 70 m	4.200
NC1007	4.3 x 113 m	6.500



Fije motokose me karrukull profil rrethor

Kodi	Trashesia	Cmimi
NC1011	3.0 x 168 m	3.900
NC1012	4.0 x 95 m	3.900

577616311



Çmimi
160

577616313



Çmimi
190

577616314



Çmimi
250

Fije motokosash e rumbullaket

15m x 1.5mm



Fije motokosash e rumbullaket

15m x 2.0mm



Fije motokosash e rumbullaket

15m x 2.4mm



577616315



Çmimi
250

ALS2001



Çmimi
1.350

577616831



Çmimi
290

Fije motokosash e rumbullaket

10m x 3.0mm















Fije motokose rumbullake

2.0mm x 450gr

























Litar starti i gatshem

























3.5mm x 2.5m

295491-0	PB400	79563		
Çmimi 990	Çmimi 850	Çmimi 650		
Disk motokose me dy tehe	Disk me 2 tehe	Disk motokose me 2 tehe te kthyer		
255 x 25.4 mm	300 x 25.4 mm	320 mm / 25,4 mm		
79560	B1	B2		
Çmimi 390	Çmimi 450	Çmimi 390		
Disk motokose i drejte me 2 tehe	Disk motokose	Disk motokose		
250 mm	Me 2 tehe 255 x 25mm	Me 2 tehe		
295494-0	ABCB05	B3		
Çmimi 1.900	Çmimi 790	Çmimi 390		
Disk motokose me tre tehe	Disk preses motokose	Disk motokose		
255 x 25.4 mm	Diametri 225 mm	Me 3 tehe 255 x 25mm		
577614201	Disk motokose me 4 tehe	79567		
Çmimi 790	Çmimi 950	Çmimi 490		
Disk motokose	Kodi	Te dhena	Çmimi	Disk motokose me 4 tehe
3 tehe Ø 255mm	577614205	Ø 230mm	790	250 mm / 25,4 mm
	577614202	Ø 255mm	950	









PB600	B12	79564
 <p>Çmimi 950</p>	 <p>Çmimi 750</p>	 <p>Çmimi 390</p>
Disk motokose me 3 tehe	Disk motokose me 3 tehe	Disk motokose me 3 tehe
300 mm - 3 mm	300 x 25 mm	2 mm / 250 mm / 25,4 mm
79565	577614206	79562
 <p>Çmimi 450</p>	 <p>Çmimi 790</p>	 <p>Çmimi 550</p>
Disk motokose me 3 tehe	Disk motokose me shume dhembe	Disk motokose me 8 tehe
2 mm / 250 mm / 25,4 mm	Ø 230 mm	250 mm / 25,4 mm
PB250	PB700	TSB423045
 <p>Çmimi 1.950</p>	 <p>Çmimi 950</p>	 <p>Çmimi 890</p>
Mbrotjese disku per motokosa	Disk motokose me 40 Dh	Disk per motokose
Me 10 dhembe	255 mm	230 mm x 40 Dh
B8	B9	B4
 <p>Çmimi 790</p>	 <p>Çmimi 790</p>	 <p>Çmimi 850</p>
Disk motokose me 36 dhembe	Disk motokose me 36 dhembe	Disk motokose
255 x 25 mm	255 x 25 mm	255 x 25 mm

1
2
3
4
5
6
7
8
9
10

B10	79566	B5
  <p>Çmimi 750</p>	  <p>Çmimi 650</p>	  <p>Çmimi 690</p>
<p>Disk motokose Me shume dhembe</p>	<p>Disk motokose me shume 40 dhembe 250 / 25,4 mm</p>	<p>Disk motokose me shume dhembe 255 x 25mm</p>
E4	E4/26	P5 / CG420.7.1-1
  <p>Çmimi 2.550</p>	  <p>Çmimi 2.550</p>	  <p>Çmimi 890</p>
<p>Koke ingranazhi me aks 28mm Per motokosa, 9 shlica</p>	<p>Koke ingranazhi me aks 26mm Per motokosa Me 9 shlica</p>	<p>Mbrojtese disku Per motokosa</p>
Y4	577616826	PB100
  <p>Çmimi 550</p>	   <p>Çmimi 990</p>	  <p>Çmimi 2.990</p>
<p>Bidon benzine & vaji 2 L</p>	<p>Rrip mbajtes motokosash Mbrojtese plastike</p>	<p>Rrip per mbajtje motokose Me dopio veshje i plote</p>
PB200	S7	S3
  <p>Çmimi 1.500</p>	  <p>Çmimi 2.250</p>	  <p>Çmimi 1.750</p>
<p>Rrip per mbajtje motokose Me mbrojtese</p>	<p>Rrip per mbajtje motokose Per motokosa</p>	<p>Rrip per mbajtje motokose Per motokosa</p>

<p>PB900</p>   <p>Çmimi 990</p>	<p>PB970</p>   <p>Çmimi 1.590</p>	<p>HFSPC01</p>   <p>Çmimi 890</p>
<p>Kokore me rrjete mbrojtese Me rrjete te imet</p>	<p>Helmete sharretari Me kufje dhe rrjete mbrojtese</p>	<p>Kokore me xham mbrojtës Me mbrojtje plastike</p>
<p>HFSPC21</p>    <p>Çmimi 690</p>	<p>HFSPC32</p>   <p>Çmimi 690</p>	<p>74468</p>   <p>Çmimi 790</p>
<p>Kokore me rrjete mbrojtese Me rrjete</p>	<p>Kokore Me xham mbrojtës</p>	<p>Kokore mbrojtese Me rrjete</p>
<p>74471</p>   <p>Çmimi 990</p>	<p>74581</p>   <p>Çmimi 590</p>	<p>HEM01</p>   <p>Çmimi 650</p>
<p>Kokore Me xham mbrojtës</p>	<p>Kufje mbrojtese per veshet Mbrojtje deri ne: 20.4 dB</p>	<p>Kufje mbrojtese per veshet Mbrojtje deri ne: 24 dB</p>
<p>HEP02</p>   <p>Çmimi 50</p>	<p>HSG02</p>   <p>Çmimi 180</p>	<p>HSG05</p>   <p>Çmimi 270</p>
<p>Tampon veshesh Per mbrojtje nga zhurma IHT</p>	<p>Syze mbrojtese E bardhe e gomuar</p>	<p>Syze mbrojtese E bardhe</p>

1
2
3
4
5
6
7
8
9
10

WX-CG301	WX-CG302	WX-CG303
		
Çmimi 3.500	Çmimi 2.900	Çmimi 3.500
Koke krasitese ligustrash	Koke sharre krasitese	Koke fryrese gjethesh
Per motokose multifunksionale WX-CG300	Per motokose multifunksionale WX-CG300	Per motokose multifunksionale WX-CG300
WX-CG304	K35	SHAKER
		
Çmimi 3.500	Çmimi 7.500	Çmimi 12.500
Koke plugimi toke 26mm	Koke shkundesë ulliri	Shkundesë ulliri
Per motokose multifunksionale WX-CG300	Per motokosa	Per motokosen MT330
K20	K25	PS2500EXT
		
Çmimi 6.990	Çmimi 1.900	Çmimi 5.900
Koke plugimi 26mm	Aksesore motokose	Bisht zgjatues per motokose PS3100
Per motokosa multifunksionale / standarte	Per korrijen e jonxhes	Gjatesia 100 cm

Motokose me benzine 3 NE 1

| Motori 26 cc | Fuqia 1 Hp | Gjeresi e prerjes 25 cm | Zinxhiri 3/8 LP 1.3 mm





KRASITËSE LIGUSTRASH

FRYRËSE GJETHESH

MOTOSHARRA

KRASITESH LIGUSTRASH ME BATERI

- | Falë peshës së ulët me krasiteset me bateri prerja e ligustrave është vërtet e lehtë.
- | Prerja të sakta, të pastra dhe të shpejta.
- | Ekran LED i dukshëm i integruar në dorezë tregon nivelin aktual të ngarkimit të baterisë gjatë punës.
- | Me zero emisione gazrash dhe me zhurmë të ulët, krasitesët e ligustrave me bateri janë një zgjidhje e mirëpritur si për profesionistët ashtu edhe për kuruesit e peizazheve.



KRASITESH LIGUSTRASH ME BATERI

- | ARCURRA
- | Max shpejtesise 1400 rpm
- | Gjatesia e lames 55 cm
- | Prerja ne min 2400 min⁻¹
- | Vetem trup



Kodi 34.109.20

CMIMI
9.900 Lek



KRASITESH LIGUSTRASH ME BATERI

- | Me 1 bateri 20 V / 2.0 Ah
- | Max shpejtesise 1400 rpm
- | Gjatesia e lames 45 cm

Kodi CHTLI20461

CMIMI
7.900 Lek



KRASITESH LIGUSTRASH ME BATERI 40V

- | Me 2 bateri 20 V / 2.0 Ah
- | Motor pa karboncina
- | Gjatesia e lames 65 cm
- | Nr. rrotullimeve bosh 3600 rpm

Kodi CHTLI400282

CMIMI
19.900 Lek





PRERESE BARI ME BATERI

- | Bateri e integruar Li-ION
3.6 V / 2.5 AH
- | Autonomia 50 min

Kodi 9853-20

CMIMI
6.900 Lek



PRERESE BARI DHE LIGUSTRASH ME BATERI

- | Tensioni 20 V
- | Vetem trup
- | Gjeresia e prerjes per ligustra
200 mm
- | Gjeresia e prerjes per bar 100 mm

Kodi CSTLI2001

CMIMI
4.500 Lek



KRASITESH LIGUSTRASH ELEKTRIKE

- | PowerCut 700/65
- | Fuqia 700 W
- | Gjatesia e lames 65 cm
- | Max. e prerjes 27 mm

Kodi 9835-20

CMIMI
18.900 Lek



MADE IN
GERMANY



KRASITESH LIGUSTRASH ELEKTRIKE

- | EasyCut 500
- | Fuqia 500 W
- | Gjatesia e lames 55 cm
- | Max. e prerjes 18 mm

Kodi 9832-20

CMIMI
12.900 Lek



MADE IN
GERMANY



KRASITESH LIGUSTRASH ELEKTRIKE

- | PowerCut 450
- | Fuqia 450 W
- | Gjatesia e lames 50 cm
- | Max. e prerjes 18 mm

Kodi 9831-34

CMIMI
12.500 Lek



MADE IN
GERMANY



KRASITESH LIGUSTRASH ELEKTRIKE

- | PowerCut 450
- | Fuqia 450 W
- | Gjatesia e lames 50 cm
- | Max. e prerjes 18 mm

Kodi 09831-20

CMIMI
11.900 Lek



MADE IN
GERMANY

1

2

3

4

5

6

7

8

9

10



KRASITESH LIGUSTRASH ELEKTRIKE

- | EasyCut 420/45
- | Fuqia 420 W
- | Gjatesia e lames 45 cm
- | Max. e prerjes 18 mm

Kodi 9830-20

CMIMI
11.500 Lek



MADE IN GERMANY



KRASITESH LIGUSTRASH ELEKTRIKE

- | GE-EH 6560
- | Fuqia 650 W
- | Gjatesia e lames 60 cm
- | Pesha 3.67 kg

Kodi 34.033.30

CMIMI
9.990 Lek



KRASITESH LIGUSTRASH ELEKTRIKE

- | GE-EH 4245
- | Fuqia 420 W
- | Gjatesia e lames 45 cm
- | Pesha 2.5 kg

Kodi 34.034.60

CMIMI
6.900 Lek



KRASITESH LIGUSTRASH ELEKTRIKE

- | Fuqia 710 W
- | Gjatesia e tehut 71 cm
- | Doreze rrotulluese 90°
- | Teh prerjes i dyfishte

Kodi EH7750

CMIMI
9.500 Lek



KRASITESH LIGUSTRASH ELEKTRIKE

- | Fuqia 450 W
- | Gjatesia e tehut 50 cm
- | Nr rrotullimeve 3500 rpm
- | Teh me dhembe

Kodi EH4510

CMIMI
6.500 Lek



KRASITESH LIGUSTRASH ME BENZINE

- | Fuqia 1.0 Hp
- | Madhesia motorit 23 cc
- | Lama 60 cm
- | Doreze e rrotullueshme

Kodi PH2500

CMIMI
25.900 Lek





KRASITËSE LIGUSTRASH ME BENZINE

- | Fuqia 1.2 Hp
- | Madhesia motorit 25.4 cc
- | Lama 70 cm
- | Lame dyshe laser cut

Kodi PH2570

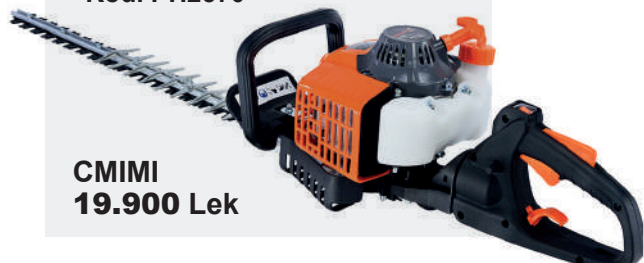

CMIMI
19.900 Lek



KRASITËSE LIGUSTRASH ME BENZINE

- | Model HT5622
- | Motori 22.7cc
- | Fuqia 0.65 kW
- | Motori me 2 kohe
- | Gjatesia tehut 56 cm

Kodi 967687801

CMIMI
14.900 Lek



KRASITËSE LIGUSTRASH ME BENZINE

- | Motori 25.4 cc
- | Fuqia 0.75 kW
- | Gjatesia tehut 55 cm

Kodi GHT5265511

CMIMI
14.500 Lek



KRASITËSE LIGUSTRASH ME BENZINE

- | Motori 1E34F-3
- | Madhesia motorit 25.4 cc
- | Fuqia 0.9 kW
- | Motori me 2 kohe
- | Gjatesia tehut 51 cm

Kodi SLP510

CMIMI
13.900 Lek



KRASITËSE MULTIFUNKSIONALE

- | Me 1 bateri 20 V / 2.0 Ah
- | Lama sharres 20 cm
- | Krasitëse ligustrash 450 mm
- | Bisht teleskopik i zgjatueshem 60 cm

Kodi CPTS201681

CMIMI
18.500 Lek



KRASITËSE DEGESH ME BATERI

- | Me 1 bateri 18 V / 2.5 Ah
- | Gjatesia totale 2390 mm
- | Shpejtesia zinxhirit 3.8 m/s
- | Pesha 3.5 kg

Kodi 14770-20

CMIMI
27.500 Lek



Einhell
**FRYRESE GJETHESH
 ME BATERI**

- | GP-LB 36/210 Li E-Solo
- | Forca fryrese 816 m³/h
- | Shpejtesia e fryrjes 210 km/h
- | Pesha 2.45 kg
- | Vetem trup

Kodi 34.336.20

**CMIMI
 12.900 Lek**



Einhell
**FRYRESE GJETHESH
 ME BATERI**

- | PT-C-EW-49 Li E-Solo
- | Momenti rrot: 15500 min
- | Shpejtesia e fryrjes 180 km/h
- | Pesha 1.22 kg
- | Vetem trup

Kodi 34.080.01

**CMIMI
 4.900 Lek**



ingco
**FRYRESE DHE THITHESE
 GJETHESH ME BATERI**

- | Tensioni 20 V
- | Shpejtesia 600-1100 rpm
- | Max fryrjes 10m³/min
- | Shpejtesia e fryrjes 190 km/h

Kodi CABLI2003

**CMIMI
 9.500 Lek**



ingco
**FRYRESE GJETHESH
 ME BATERI**

- | Tensioni 20 V
- | Shpejtesia 15000 rpm
- | Max fryrjes 8.5m³/min
- | Volumi ajrit 38m³/s
- | Vetem trup

Kodi CABLI20428

**CMIMI
 7.500 Lek**



ingco
**FRYRESE GJETHESH
 ME BATERI**

- | Me nje bateri 20 V / 2.0 Ah
- | Shpejtesia 15000 rpm
- | Max fryrjes 8.5m³/min
- | Shpejtesia e fryrjes 115 km/h

Kodi CABLI203235

**CMIMI
 5.900 Lek**



ingco
**FRYRESE GJETHESH
 ME BATERI**

- | Me nje bateri 20 V / 2.0 Ah
- | Shpejtesia 18000 rpm
- | Max fryrjes 2.7 m³/min

Kodi CABLI200181

**CMIMI
 5.900 Lek**





FRYRESE GJETHESH ME BATERI

- | Tensioni 20 V
- | Max fryrjes 2.7 m³/min
- | Vetem trup

Kodi CABLI2001

CMIMI
4.500 Lek



FRYRESE GJETHESH ME BATERI

- | Tensioni 20 V
- | Max fryrjes 2.7 m³/min
- | Vetem trup

Kodi CABLI20018

CMIMI
2.500 Lek



FRYRESE GJETHESH ME BATERI

- | Tensioni 20 V
- | Max fryrjes 2.7 m³/min
- | Vetem trup



Kodi CABLI20028

CMIMI
1.900 Lek



FRYRESE GJETHESH ELEKTRIKE

- | Fuqia 400 W
- | Shpejtesia 14000 rpm

Kodi AB4038

CMIMI
1.900 Lek



FRYRESE GJETHESH ME BATERI

- | Tensioni 20 V
- | Max fryrjes 8.3 m³/min
- | Bateria 2.0 Ah



Kodi WBLP521

CMIMI
4.900 Lek



FRYRESE GJETHESH ME BATERI

- | Tensioni 20 V
- | Max fryrjes 2.5 m³/min
- | Bateria 1.5 Ah



Kodi WBLP511

CMIMI
3.900 Lek



incco
Professional Tools. Made in Thailand.

FRYRESE GJETHESH ELEKTRIKE

- | Fuqia 800 W
- | Shpejtesia 15000 rpm

Kodi AB8008

CMIMI
5.500 Lek



incco
Professional Tools. Made in Thailand.

FRYRESE GJETHESH ELEKTRIKE

- | Fuqia 650 W
- | Me shpejtesi te rregullueshme

Kodi AB6038

CMIMI
2.900 Lek



Einhell

FRYRESE / THITHESE GJETHESH

- | Fuqia 3000 W
- | Volumi i qeses 40 Lt
- | Max fryrjes 650 m³/h
- | Shpejtesia e fryrjes 240 km/h

Kodi 34.333.70

CMIMI
6.500 Lek



FORCE
MACHINERY - TOOLS

FRYRESE GJETHESH ASPIRATOR ME BENZINE

- | Motori 42.7 CC / 1E40F
- | Fuqia 1.25 kW
- | Depozita 0.5 Lt
- | Pesha 5.2 Kg

Kodi EBV260

CMIMI
19.900 Lek



FORCE
MACHINERY - TOOLS

FRYRESE GJETHESH SHPINE ME BENZINE

- | Motori 32.6 CC / 1E36F
- | Fuqia 0.9 kW
- | Nr. rrotullimeve 7000 rpm
- | Pesha 10.5 Kg

Kodi EB975

CMIMI
27.500 Lek



FORCE
MACHINERY - TOOLS

FRYRESE GJETHESH ME BENZINE

- | Motori 25.4 CC / me 2 kohe
- | Fuqia 0.75 kW
- | Depozita 0.5 Lt
- | Pesha 5.2 Kg

Kodi EB260

CMIMI
14.900 Lek



MOTOSHARRE ME BATERI

- | Tensioni 40V (20+20)
- | Shpata Oregon 40 cm
- | Motor pa karboncina
- | Shpejtesia e zinxhirit 14.5 m/s
- | Përfshire 2 bateri 4.0 Ah

Kodi CGSLI401682

CMIMI
26.900 Lek



MOTOSHARRE KRASITSE ME BATERI

- | Me 2 bateri 20 V / 4.0 Ah
- | Shpata 30 cm
- | Motor pa karboncina
- | Shpejtesia zinxhirit 3700-4500rpm

Kodi CGSLI201286

CMIMI
18.500 Lek



MOTOSHARRE KRASITSE ME BATERI

- | Tensioni 20 V
- | Shpata 30 cm
- | Motor pa karboncina
- | Shpejtesia zinxhirit 3700-4500rpm
- | Vetem trup

Kodi CGSLI20128

CMIMI
14.900 Lek



MOTOSHARRE KRASITSE ME BATERI

- | Me 1 bateri 20 V / 2.0 Ah
- | Shpate 20 cm
- | Shpejtesia e zinxhirit 7.5m/s
- | Motor pa karboncina
- | Ka te pershire nje graso 15 ml

Kodi CGSLI20851

CMIMI
9.900 Lek



MOTOSHARRE KRASITSE ME BATERI

- | Me 2 bateri 20 V / 2.0 Ah
- | Shpate 15 cm
- | Motor pa karboncina
- | Shpejtesia e zinxhirit 11m/s

Kodi CGSLI20682

CMIMI
14.900 Lek



SHARRE MINI ME BATERI

- | Me bateri 20 V / 2.0 Ah
- | Shpate 13 cm
- | Shpejtesia e zinxhirit 5.0m/s

Kodi CGSLI20581

CMIMI
6.900 Lek





MOTOSHARRE ME BATERI

- | FORTEXXA 18/30
- | Tensioni 18 V
- | Shpate 30 cm
- | Motor pa karboncina
- | Pesha 4.03 Kg
- | Vetem trup

Kodi 46.000.10

CMIMI 18.500 Lek



SHARRE MINI ME BATERI

- | Me bateri 20 V / 1.5 Ah
- | Shpate 13 cm
- | Shpejtesia e zinxhirit 4.8m/s

Kodi WCLP552

CMIMI 5.500 Lek



ELEKTROSHARRE ME VETEMPREHJE 2400 W

- | CS1500
- | Fuqia: 2400 Wat
- | Shpejtesia e zinxhirit: 14.7 m/second
- | Zinxhiri: PowerSharp® 3/8 file™ .050"
- | Mekanizem vetemprehje
- | Shpata: 45 cm (18")
- | Pesha: 5.7 kg (12.6 lb)
- | Sistem automatik i shtrengimit te zinxhirit
- | Pompe vaji automatike

Kodi 604419 + 542656

CMIMI 19.900 Lek



FALAS



ELEKTROSHARRE 1800 W

- | CS1200
- | Fuqia: 1800 Wat
- | Shpejtesia e zinxhirit: 14.7 m/second
- | Zinxhiri: PowerSharp® 3/8 file™ .050"
- | Mekanizem vetemprehje
- | Shpata: 40 cm (16")
- | Sistem automatik i shtrengimit te zinxhirit
- | Pompe vaji automatike

Kodi 620370 + 91305L

CMIMI 14.500 Lek



FALAS



ELEKTROSHARRE

- | EKI 2200/40
- | Fuqia: 2200 Wat
- | Motor horizontal
- | Shpata 40 cm
- | Zinxhiri 3/8" 1.1 / 91PX056E
- | Tensioni i zinxhirit me regjistrues
- | Lubrifikimi automatik i zinxhirit
- | Pesha 5.4 kg

Kodi 112809

CMIMI
19.900 Lek

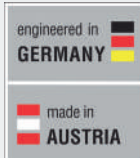

ELEKTROSHARRE

- | EKS 2000/35
- | Fuqia: 2000 Wat
- | Motor vertikal
- | Shpata 35 cm
- | Zinxhiri 3/8" 1.1 / 91PX052E
- | Tensioni i zinxhirit me celes
- | Lubrifikimi automatik i zinxhirit
- | Pesha 4.8 kg

Kodi 112807

CMIMI
17.900 Lek

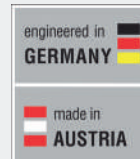

ELEKTROSHARRE

- | GC-EC 2040
- | Fuqia: 2000 W
- | Shpate 40 cm
- | Zinxhiri: mm
- | Shpejtësia e prerjes 15.5 m/s
- | Pesha: 4.95 kg

Kodi 45.012.30

CMIMI
12.500 Lek



ELEKTROSHARRE

- | GC-EC 1935-RED
- | Fuqia: 1900 W
- | Shpate: 35 cm
- | Zinxhiri: 1.3 mm
- | Shpejtësia e prerjes 15.5 m/s
- | Pesha: 4.65 kg

Kodi 45.012.20

CMIMI
11.500 Lek



1
2
3
4
5
6
7
8
9
10



- Teknologjia e re e motorit OxyPower - deri në 20% kursim të karburantit deri në 70% zvogëlim i tymrave ndotëse / fuqi prerëse më e lartë në krahasim me motorin konvencional dy-kohësh.
- Sistemi i pastrimit të ajrit në hyrje me centrifugë. Nevojë e ulët për mirëmbajtjen e filtrit të ajrit dhe reduktim i dëmtimeve të pjesëve të lëvizshme të motorit.
- Sistemi i ndezjes Soft Start - Zvogëlon fuqinë që duhet të aplikohet për të nisur motorin deri në 40%. Sistemi i amortizimit të dridhjeve - Zvogëlon lodhjen e operatorit gjatë punës.



MOTOSHARRE ME BENZINE



Made in USA

- | CS50S
- | Motori: 50cc
- | Fuqia: 2.8HP
- | Shpata: 45 cm
- | Pesha: 5.9kg

Kodi 967300301

ERE

CMIMI
24.900 Lek



MOTOSHARRE ME BENZINE

- | CS380TL
- | Motori: 38cc
- | Fuqia: 1.4 Kw
- | Shpata: 40 cm
- | Pesha: 5.2kg

Kodi 967326303

CMIMI
17.900 Lek

ERE



MOTOSHARRE ME BENZINE

- | CS35
- | Motori: 35cc
- | Fuqia: 1.4 Kw
- | Shpata: 35 cm
- | Pesha: 4.6kg

Kodi 967624614

CMIMI
15.900 Lek

ERE



NAKAYAMA
PRO

MOTOSHARRE ME BENZINE

- | Fuqia 2.6 HP Motori 50 cc
- | Shpata 50 cm
- | Zinxhiri .325", 1.5 mm (76Dh)
- | Treguese i nivelit te vajit
- | Rregullim anesore i zinxhirit
- | Pompe vaji automatike / e rregullueshme
- | Pesha 5 Kg

Kodi PC5600

CMIMI
19.900 Lek



NAKAYAMA
PRO

MOTOSHARRE ME BENZINE

- | Fuqia 2.45 HP Motori 45 cc
- | Shpata 45 cm
- | Zinxhiri .325", 1.3 mm (72Dh)
- | Treguese i nivelit te vajit
- | Rregullim anesore i zinxhirit
- | Pompe vaji automatike / e rregullueshme
- | Pesha 4.6 Kg

Kodi PC4600

CMIMI
16.900 Lek



INGCO
Professional Tools Made Affordable

MOTOSHARRE ME BENZINE

- | Motori 62 cc
- | Shpata Oregon 60 cm
- | Zinxhiri .325", 1.3 mm (72Dh)
- | Treguese i nivelit te vajit
- | Rregullim anesore i zinxhirit
- | Pompe vaji automatike / e rregullueshme
- | Pesha 4.6 Kg

Kodi GCS5602411

CMIMI
19.500 Lek



**OREGON
CHAIN**

INGCO
Professional Tools Made Affordable

MOTOSHARRE ME BENZINE

- | Motori 46 cc
- | Shpata 45 cm
- | Zinxhiri .325", 1.3 mm
- | Fuqia 1.8 kW
- | Motor i fuqishem me 2 kohe
- | Rezervuar karburanti 550 ml

Kodi GCS5451811

CMIMI
12.900 Lek



MOTOSHARRE KRASITASE ME BENZINE



- | BKS 2625 T
- | Motori 25.4 ccm
- | Fuqia 0.9 kW / 1.2 Hp
- | Shpata 25 cm, zinxhiri 3/8" spec.
- | Lubrikimi automatik i zinxhirit
- | Pesha 3.2 kg



Kodi 113355

CMIMI
24.500 Lek



MOTOSHARRE KRASITASE ME BENZINE



- | Motor me 2 kohe 25.4 cc
- | Fuqia 1.1 HP
- | Shpata 25 cm Zinxhiri 3/8" LP (40 Dh) 1.3 mm Pesha 3 Kg
- | Rregullim anesor i zinxhirit
- | Pompe vaji automatik / i rregullueshem

Kodi PC3100

CMIMI
14.500 Lek



MOTOSHARRE KRASITASE ME BENZINE



- | Motori 25.4 cc
- | Shpata 25 cm
- | Fuqia 0,7 kW (1 HP)
- | Rezervuar karburanti 230 ml
- | Motor i fuqishem me 2 kohe

Kodi GCS5261011

CMIMI
12.900 Lek



GRIRËSE DEGËSH



- | Fuqia: 2500 W
- | Max diametrit të degës 40 mm
- | Pesha: 24.85 kg

Kodi 34.306.20

CMIMI
29.900 Lek

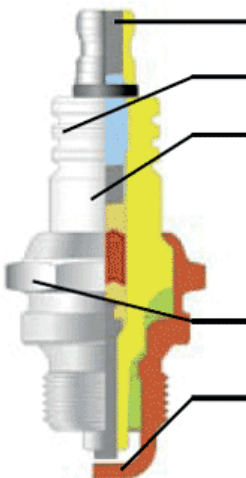

- Adaptori lidhes**
Lidhje te qendrushme dhe rezistence gjate dridhjeve
- Unaza ndarese**
Per eliminimin e shkendijave ne trup
- Unaze mbrojtese**
Permbajtje e larte e aliazhit te aluminit per te eliminuar mbinxehjen, shkendijat elektrike dhe rezistence nga goditjet termike.
- Unaze izoluese**
Mbron kandelen nga nxehtesia e tepert si dhe ofron lehtësi ne heqjen e kandeles.
- Fileto mashkull**
Fale lidhjes te forte Nikel - Zink ofrohet nje rezistence e larte ndaj ndryshkut.
- Elektroda qendrore**
Aliazhi i zinkut ofron nje rezistence te larte ndaj ndryshkut, nxehtesise te larte dhe qendrushmeri me te larte



Kodi	Champion		Çmimi
77-306-1	OPR-17	Motosharra, motokosa	350
77-305-1	RJ19LM	Briggs&Stratton, Tecumseh	350
77-315-1	N9YC	Honda OHC, Robin EHV	350
77-355-1	TR15C	HQT3 Husqvarna, Stihl	490
77-321-1	I86C	Honda, Zenoah, Bertoloni	350
77-307-1	RCJ6Y	Motokosa Husqvarna, Stihl	350
77-324-1	RCJ7Y	Husqvarna, Stihl	350

KANDELE UNIVERSALE

E RE

Kodi	Përshkrimi	Çmimi
577616606	Kandele RC12YC me qafe te gjate per korrese bari 16mm	220
577616602	Kandele RCJ7Y me qafe te shkurter per motora 2-kohe H19mm	200
577616604	Kandele RDJ7Y me qafe te shkurter per motora 2-kohe H16mm	250
577616603	Kandele RDJ8J me qafe te shkurter per motora 2-kohe H16mm	250
577616601	Kandele RJ19LM per korrese bari H21mm	200
577616605	Kandele RN9YC me qafe te gjate per motora me 4-kohe H21mm	210
577616608	Kandele champion per motora me 2-kohe H19mm	210
577616610	Kandele per motora 2T/4T H19mm	160
577616612	Kandele me qafe te gjate per motora 4-kohe	160
577616607	Kandele CMR7H per motora me 2-kohe H16mm	250



ASORTMENTI I KANDELEVE

GAMA E KANDELEVE

- TABELA E REFERENCAVE -

SPECIFIKAT

HUSQVARNA	MCCULLOCH	OREGON	CHAMPION	NGK	BOSCH	BRISK	BRIGGS & STRATTON	HONDA	KAWASAKI	KOHLER	TORCH	MASA HEXAGON	PER
5774840-01	577616602	77-324-1	RCJ7Y	BPMR7A	WSR7F	PR17YC					L7RTC	19 mm	Motora me 2-kohe
5907101-01		77-307-1	RCJ6Y	BPMR8A	WSR5F	PR15YC					L8RTC	19 mm	Motora me 2-kohe
5908438-01		77-355-1		CMR6H	USR7AC	TR15C						16 mm	Motora me 2-kohe
5907102-01			RY4C	CMR6A		SR15C					AC6RA	16 mm	
5908440-01			RZ7C	CMR7H	USR4AC	TR14C					CMR7H	16 mm	Motora me 2-kohe
5908441-01	577616601	77-305-1	RJ19LM	BR2LM	WR11E0	JR19	992302		E 9207 02055		BR2LM	22 mm	Mot. 4 kohe Korrese bari
5908442-01	577616605	77-315-1	RN9YC	BPR6ES	WR7DC	LR15YC		98079- 55871	E 9207 02077		F6RTC	21 mm	
5908443-01	577616607			CMR5H		TR17C						16 mm	Motora me 2-kohe
5908444-01	577616606		RC12YC	BCPR5ES	FR8DC	DR17YC	792015 & 992304 & 692720			1213202	K5RTC	16 mm	Mot. 4 kohe B&S OHV/DOV
5908445-01	577616603		RDJ8J	BMR6F		UR17					N6RC	16 mm	Motora me 2-kohe
5964210-01			RN14YC	BPR4ES	WR7DC	LR19YC						21 mm	Mot. 4 kohe HONDA KAWASAKI
	577616608	77-306-1	RCJ8	BMR6A	WSR7E	PR17					L6RC	19 mm	Motora me 2-kohe
	577616610	77-319-1	RCJ8Y	BPMR6A	WSR8F	PR18Y					L6RTC	19 mm	Mot. 4 kohe HH/ Kaw.engines
	577616604		RDJ7Y	BPMR6F		UR15					N6RTC	16 mm	Motora me 2-kohe
	577616612		RC7YC		FR6DC	DR14YC					K7RTCIF	16 mm	Mot. 4 kohe Korrese bari

Lima zinxhiri rrethore (12cope)



Çmimi
2.590

Ø=	Ø=mm	L=’’/mm	Kutia
9/64	3.6	8/200	LC10000-03-964
5/32	4.0	8/200	LC10000-03-532
11/644	4.5	8/200	LC10000-03-45
3/16	4.8	8/200	LC10000-03-316
13/64	5.2	8/200	LC10000-03-1364
7/32	5.5	8/200	LC10000-03-732

Doreza druri Woody

Per lima rrumbullake.



Çmimi
150

Kodi	L=mm	Lloji	
AL340	100	Ø 5/32’’ -> 5/16’’	1

Doreza Cobra

Per lima petashuqe



Çmimi
220

Kodi	L=mm	Lloji	
AL250	90	/	12

12211

Lima zinxhiri OREGON

Lima zinxhiri OREGON

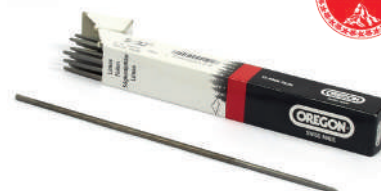

Çmimi
5.900

Lima OREGON

Petashuqe

Kodi	Te dhena	Çmimi
105898	3.6mm	250
70504	4.0mm	250
70511	4.5mm	250

Kodi	Te dhena	Çmimi
70503	4.8mm	250
70505	5.2mm	250
70502	5.5mm	250

577615701

Set me 2 lima

577615705



Çmimi
990

Çmimi
290

Set me 2 lima 4.0mm

Lime te sheshte dhe doreze

Kodi	Te dhena	Çmimi
577615703	4.5mm	290
577615704	4.8mm	290

Set me 2 lima

5.5mm

577615707

79861

79862



Çmimi
290

Çmimi
290

Çmimi
290

Lime e sheshte

6.0mm

Lima (3 cope)

4.0 mm

Lima (3 cope)

4.5 mm

577616420 IRI 	577616519 IRI 	91305L
Çmimi 850	Çmimi 1.450	Çmimi 1.490
Bidon benzine 5 L	Doreza sharrtari Masa XL 10"	Doreza lekure Masa L
ES2310 	ES9100 	LB1150
Çmimi 12.900	Çmimi 850	Çmimi 1.590
Mprehese zinxhiri 230W Disku $\Phi 145 \times 22.2 \times 3.2$ mm	Gurë mprehës zinxhirash Modeli i zinxhirit: $\Phi 145 \times 22.2 \times 3.2$ mm	Vaj zinxhiri i biodegradueshem 1 Lt
57-036 	57-043 	57-039
Çmimi 320	Çmimi 320	Çmimi 490
Celesa kandelesh OREGON 13x19x55	Celesa kandelesh OREGON 13x19x68	Celesa kandelesh OREGON 13x19x78
Litar starteri Made in Germany 	Litar starteri Made in Germany 	Litar starteri Made in Germany
Kodi Te dhena Çmimi	Kodi Te dhena Çmimi	Kodi Te dhena Çmimi
90200 3.0mm 3.900	90202 4.0mm 5.900	90204 5.0mm 7.500
90201 3.5mm 4.500	90203 4.5mm 6.500	90205 5.5mm 8.500

1
2
3
4
5
6
7
8
9
10

OREGON Shpikësi i zinxhirit të motosharrave

Zinxhirët Oregon përshtaten me të gjitha markat prodhuese të motosharrave.

KUJDESI!
Vetem zinxhirit Oregon kanë të stampuar mbi dhembe logon OREGON



	Kodi	Hapi	Profili	Kanali	Nr. i dhembeve	Çmimi /top
	90PX100R	3/8 LOW PRO		.043" 1.1 mm	820	39.500
	91P100R	3/8 LOW PRO		.050" 1.3 mm	820	32.900
	91VXL100R	3/8 LOW PRO		.050" 1.3 mm	820	37.500
	20LPX100R	0.325		.050" 1.3 mm	924	47.500
	21LPX100R	0.325		.058" 1.5 mm	924	47.500
	72LPX100R	3/8		.050" 1.3 mm	820	47.500
	73LPX100R	3/8		.058" 1.5 mm	820	45.900
	73EXL100R	3/8		.058" 1.5 mm	816	44.500
	75LPX100R	3/8		.063" 1.6 mm	820	45.900
	75EXL100R	3/8		.063" 1.6 mm	816	37.500

Zinxhir i gatshem 3/8" 1.1mm - 3/8 1.3mm



Made in USA

Kodi	Hapi	Profili	Kanali	Nr. i dhembeve	Çmimi
90PX040E	3/8"	7	.043" 1.1 mm	20	1.490
90PX044E	3/8"	7	.043" 1.1 mm	22	1.590
90PX045E	3/8"	7	.043" 1.1 mm	22.5	1.690
90PX050E	3/8"	7	.043" 1.1 mm	25	1.750
90PX052E	3/8"	7	.043" 1.1 mm	26	1.790
90PX055E	3/8"	7	.043" 1.1 mm	27.5	2.590
90PX057E	3/8"	7	.043" 1.1 mm	28.5	2.590
90PX058E	3/8"	7	.043" 1.1 mm	29	2.650
91P032E	3/8"	7	.050" 1.3 mm	16	990
91P040E	3/8"	7	.050" 1.3 mm	20	1.100
91P044E	3/8"	7	.050" 1.3 mm	22	1.150
91P045E	3/8"	7	.050" 1.3 mm	22.5	1.190
91P046E	3/8"	7	.050" 1.3 mm	23	1.290
91P050E	3/8"	7	.050" 1.3 mm	25	1.350
91P052E	3/8"	7	.050" 1.3 mm	26	1.390
91P054E	3/8"	7	.050" 1.3 mm	27	1.490
91P055E	3/8"	7	.050" 1.3 mm	27.5	1.550
91P056E	3/8"	7	.050" 1.3 mm	28	1.690
91P057E	3/8"	7	.050" 1.3 mm	28.5	1.690
91P058E	3/8"	7	.050" 1.3 mm	29	1.750
91P060E	3/8"	7	.050" 1.3 mm	30	1.790
91P062E	3/8"	7	.050" 1.3 mm	31	1.890
91P064E	3/8"	7	.050" 1.3 mm	32	1.990
91P068E	3/8"	7	.050" 1.3 mm	34	2.150
91P072E	3/8"	7	.050" 1.3 mm	36	2.250

1

2

3

4

5

6

7

8

9

10

Zinxhir i gatshem 0.325 1.3mm - 3/8" 1.5 mm - 3/8" 1.6 mm

	Kodi	Hapi	Profili	Kanali	Nr. i dhembeve	Çmimi
	20LPX050E	0.325		050" 1.3 mm	25	2.200
	20LPX060E	0.325		050" 1.3 mm	30	2.390
	20LPX064E	0.325		050" 1.3 mm	32	2.500
	20LPX066E	0.325		050" 1.3 mm	33	2.790
	20LPX068E	0.325		050" 1.3 mm	34	2.850
	20LPX072E	0.325		050" 1.3 mm	36	2.850
	20LPX074E	0.325		050" 1.3 mm	37	2.990
	20LPX076E	0.325		050" 1.3 mm	38	3.150
	73LPX060E	3/8"		.058" 1.5 mm	30	2.390
	73LPX064E	3/8"		.058" 1.5 mm	32	2.200
	73LPX066E	3/8"		.058" 1.5 mm	33	2.500
	73LPX068E	3/8"		.058" 1.5 mm	34	2.500
	73LPX072E	3/8"		.058" 1.5 mm	36	2.690

571039



Çmimi
4.900

Zinxhir 3/8 1.3mm + Gur vetemprehës

Për motosharrën CS1500

Set zinxhir + lame + yllez Kit Nano (1.1mm)



E RE

Kodi	Te dhena	Çmimi
614379	25cm 0.325" per Stihl	4.500
637264	25cm 0.325" per HQ T525	4.690
614391	30cm 0.325" per HQ T435	4.790

Zinxhir i gatshem 24AP 1/4" (1.1mm)



E RE

Kodi	Te dhena	Çmimi
24AP028E	10cm 14dh	2.800
24AP056E	25cm 28dh	2.900

Zinxhir i gatshem 24AP 1/4" (1.1mm)



E RE

Kodi	Te dhena	Çmimi
24AP060E	25cm 30dh	3.100
24AP068E	30cm 34dh	3.500

► Oregon kompania me e madhe ne bote e prodhimit te zinxhirave, shpatave, aksesoreve te pylltarise si dhe makinerive per me shume se 70 vite. Oregon mban mbi supe prodhimin e zinxhirave dhe aksesoreve per brandet me te medha te prodhimit te motosharrave.

- Game e plote e shpatave te motosharrave
- Te pershtatshme per amatore, profesioniste dhe gjysem profesioniste
- Teknologji e avancuar dhe cilesi e larte e garantuar nga OREGON



PowerSharp®
Sistem i lehte per tu perdorur dhe duke ofruar precizion te larte ne prerje ne vetem pak sekonda. Shpatat te cilat pershtaten per sistemin kane te shenuar ne trup PowerSharp® ne menyre qe te pershtaten me vrimat perkatese.



Lubri-Dam®
Sistemi Lubri-Dam eshte dizenuar ne menyre qe me cdo kalim te zinxhirit te arrije te transportoje vajin ne te gjitha rrugen e zinxhirit.



LubriJet®
Sistemi LubriJet® arrin te drejtoje vajin nepermjet vrimes me kend ne xhepin e mbajtjes se vajit e me pas ne hallkat e zinxhirit duke ekspozuar zinxhirin ndaj vajit me 50 %.



MICRO-LITE®
Sistemi MICRO-LITE® krijon nje ngushtim te shpates ne krahasim me shpatat standarte nepermjet te ciles rritet performanca e motosharres dhe reduktohet niveli i zhurmes.



SINGLE RIVET



ADVANCECUT



SPEEDCUT

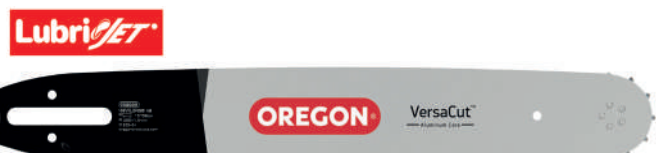

VERSACUT



POWERCUT



DURACUT

1
2
3
4
5
6
7
8
9
10

SHPATA PER MOTOSHARRA STIHL



	Kodi	Gjatesia	Kapja	Hapi	Kanali	Nr. i dhembeve	Çmimi
	120SDEA074	12" (30 cm)		3/8"	.050" 1.3 mm	44	1.890
	140SDEA074	14" (35 cm)		3/8"	.050" 1.3 mm	50	2.100
	160SDEA074	16" (40 cm)		3/8"	.050" 1.3 mm	55	2.400
	153SFGD025	15" (38 cm)		0.325"	.050" 1.3 mm	60	2.500
	163SFGD025	16" (40 cm)		0.325"	.063" 1.6 mm	67	2.700
	183SFGD025	18" (45 cm)		0.325"	.050" 1.3 mm	74	2.500
	183SFHD025	18" (45 cm)		3/8"	.063" 1.6 mm	66	2.700
	140SXEA074	20" (50 cm)		3/8"	.063" 1.3 mm	50	2.690
	203SFHD025	20" (50 cm)		3/8"	.063" 1.6 mm	72	2.900

SHPATA PER MOTOSHARRA HUSQVARNA





	Kodi	Gjatesia	Kapja	Hapi	Kanali	Nr. i dhembeve	Çmimi
	100SDEA041	10" (25 cm)		3/8"	.050" 1.3 mm	44	1.490
	124MLEA041	12" (30 cm)		3/8"	.043" 1.1 mm	45	1.850
	144MLEA041	14" (35 cm)		3/8"	.043" 1.1 mm	52	2.190
	144MLEA074	14" (35 cm)		3/8"	.043" 1.1 mm	52	2.200
	120SDEA041	12" (30 cm)		3/8"	.050" 1.3 mm	50	1.900
	140SDEA041	14" (35 cm)		3/8"	.050" 1.3 mm	52	2.290
	160SDEA041	16" (40 cm)		3/8"	.050" 1.3 mm	56	2.390
	140SDEA318	14" (35 cm)		3/8"	.050" 1.3 mm	50	2.200
	160SDEA318	16" (40 cm)		3/8"	.050" 1.3 mm	54	2.490
	180SDEA041	18" (45 cm)		3/8"	.050" 1.3 mm	62	2.850
	160SXEA074	16" (40 cm)		3/8"	.050" 1.3 mm	55	2.900
	180MLBK095	18" (45 cm)		0.325"	.050" 1.3 mm	72	3.350
	188ATMD009	18" (45 cm)		3/8"	.058" 1.5 mm	68	9.500
	150MLBK095	15" (38 cm)		0.325"	.050" 1.3 mm	64	2.790
	160MLBK095	16" (40 cm)		0.325"	.050" 1.3 mm	67	2.990
	188SFHD009	18" (45 cm)		0.325"	.050" 1.5 mm	68	3.100
	203VXLHD025	20" (50 cm)		3/8"	.063" 1.6 mm	72	4.700

SHPATA PER MOTOSHARRA

IRI

Kodi	Gjatesia	Hapi	Kanali	Nr. i dhembeve	Çmimi
 577614323	14" (35cm) (Stihl)	3/8"	1.3mm A318	25	1.250
 577614378	14" (35cm)	3/8"	1.3mm A095	26	1.350
 577614370	16" (40cm) (Stihl)	3/8"	1.3mm T318	27.5	1.450
 577614334	16" (40cm)	3/8"	1.3mm K095	28	1.350
 577614371	18" (45cm) (Stihl)	3/8"	1.3mm T318	30	1.550
 577614348	18" (45cm)	3/8"	1.3mm A041	31	1.690
 577614376	15" (38cm)	.325"	1.3mm K095	32	2.450
 577614355	18" (45cm) (Stihl)	.325"	1.3mm K095	36	2.750





ZINXHIR I GATSHEM 3/8" MINI 1.1MM

Kodi	Gjatesia	Hapi	Kanali	Nr. i dhembeve	Çmimi
 577615101	12" (30cm)	3/8"	.043" 1.1mm	44	1.350
 577615103	12" (30cm)	3/8"	.043" 1.1mm	46	1.390
 577615105	14" (35cm)	3/8"	.043" 1.1mm	52	1.450

ZINXHIR I GATSHEM 3/8" MINI 1.3MM

Kodi	Gjatesia	Hapi	Kanali	Nr. i dhembeve	Çmimi
 577615114	12" (30cm)	3/8"	.050" 1.3mm	44	1.190
 577615119	12" (30cm)	3/8"	.050" 1.3mm	49	1.350
 577615120	14" (35cm)	3/8"	.050" 1.3mm	49	1.350
 577615121	12" (30cm) (Stihl)	3/8"	.050" 1.3mm	50	1.390
 577615122	12" (30cm)	3/8"	.050" 1.3mm	52	1.450
 577615126	16" (40cm) (Stihl)	3/8"	.050" 1.3mm	55	1.550
 577615127	16" (40cm)	3/8"	.050" 1.3mm	56	1.590

ZINXHIR I GATSHEM 0.325"

Kodi	Gjatesia	Hapi	Kanali	Nr. i dhembeve	Çmimi
 577615153	15" (38cm) (Stihl)	0.325"	.058" 1.5mm	64	1.590
 577615134	14" (38cm)	0.325"	.050" 1.3mm	64	1.690
 577615148	16" (40cm)	0.325"	.050" 1.3mm	66	1.690
 577615150	18" (45cm)	0.325"	.050" 1.3mm	72	1.790



SHPATA PER MOTOSHARRA

ERE

Kodi	Gjatesia	Hapi	Kanali	Nr. i dhembeve	Çmimi
 YT-84916	(25cm)	3/8"	1.1mm	40	790
YT-84917	(30cm)	3/8"	1.1mm	45	850
YT-84925	(25cm)	3/8"	1.3mm	40	790
YT-849299	(30cm) (Stihl)	3/8"	1.3mm	44	790
YT-84930	(36cm) (Stihl)	3/8"	1.3mm	50	950
YT-84931	(36cm)	3/8"	1.3mm	52	950
YT-849301	(40cm) (Stihl)	3/8"	1.3mm	55	990
YT-84935	(40cm)	3/8"	1.3mm	56	990
YT-849331	(40cm)	0.325"	1.3mm	66	990
YT-849332	(45cm)	0.325"	1.3mm	72	1.100
YT-84933	(50cm)	0.325"	1.3mm	78	1.150



ZINXHIR PER MOTOSHARRA

IRI

Kodi	Pershkrimi	Hapi	Kanali	Nr. i dhembeve	Çmimi
 YT-84959	Zinxhir top	3/8"	1.1mm	816	14.500
YT-84960	Zinxhir top	3/8"	1.3mm	816	15.500
YT-84963	Zinxhir top	0.325"	1.5mm	923	19.500
YT-84953	Zinxhir i gatshem	3/8"	1.3mm	54	990

AGSB51001

INGCO



Çmimi
1.190

AGSB51202

INGCO



Çmimi
1.850

Shpate motosharre

25 cm, per GCS5261011

Shpate motosharre

30 cm, per CGSLI2001, CGSLI20128, CGSLI201286

AGSB51801

INGCO



Çmimi
1.690

AGSB52401

INGCO



Çmimi
2.990

Shpate motosharre

45 cm, per GCS5451811







Shpate motosharre





60 cm, per GCS5602411

AGSB50501	AGSB50801	AGSB51603
		
		
Çmimi 790	Çmimi 990	Çmimi 1.490

Shpate motosharre	Shpate motosharre	Shpate motosharre
12 cm, 1/4", 1.1 mm	20 cm, 1/4", 1.1 mm	40 cm, 3/8", 1.3 mm

ZINXHIR PER MOTOSHARRA

	AGSC50501 Zinxhir motosharre 1/4", 0.043", 32 DH, 12cm	800 Leke
	AGSC50801 Zinxhir motosharre 3/8", 0.043", 33 DH, 20cm	990 Leke
	AGSC51001 Zinxhir motosharre 25 cm, i pershtashem per GCS5261011	1.250 Leke
	AGSC51201 Zinxhir motosharre, i pershtashem per CGSLI2001, CGSLI20128, CGSLI201286, UCGSLI201286	1.450 Leke
	AGSC51603 Zinxhir motosharre 3/8", 0.043", 56 DH, 40cm	1.550 Leke
	AGSC51801 Zinxhir motosharre 45 cm, i pershtashem per GCS5451811	1.690 Leke
	AGSC52401 Zinxhir motosharre 60 cm per GCS5602411	2.990 Leke













24548B	24549B
	
	
Çmimi 14.900	Çmimi 13.900

Ç'perçinuese zinxhiri OREGON

Për keputjen e zinxhireve 3/8 .325, 3/8 pro, 404"025

Percinuese për perçiminin e zinxhireve

3/8, 325, 3/8 pro, 404"

<p>YT-84970</p> <p>YATO </p>  <p>Çmimi 5.900</p>	<p>YT-84971</p> <p>YATO </p>  <p>Çmimi 7.500</p>	<p>P23843</p> <p>OREGON </p>  <p>Çmimi 2.150</p>
<p>Percinuese Zinxhiri</p> <p>2.1mm 1/4 Metalike A3</p>	<p>Cpercinuese Zinxhiri</p> <p>1/4, 0.325, 3/8, 0.404, 90-91P</p>	<p>Percina</p> <p>.325 - 1.3 - 1.5 - 1.6 mm</p>
<p>P31939</p> <p>OREGON </p>  <p>Çmimi 2.900</p>	<p>P23910</p> <p>OREGON </p>  <p>Çmimi 2.900</p>	<p>P24295</p> <p>OREGON </p>  <p>Çmimi 2.150</p>
<p>Percina</p> <p>.325 - 1.3 - 1.5 mm</p>	<p>Percina</p> <p>3/8" - 1.3 - 1.5 mm</p>	<p>Percina</p> <p>3/8" - 1.3 mm mini</p>
<p>100962X</p> <p>OREGON </p>  <p>Çmimi 2.150</p>	<p>100791X</p> <p>OREGON </p>  <p>Çmimi 2.350</p>	<p>38145X</p> <p>OREGON </p>  <p>Çmimi 2.450</p>
<p>Kupe freksioni per motosharra</p> <p>Stihl 017, 018, 019, 021, 023</p>	<p>Kupe freksioni PRO 325-7Dh</p> <p>Stihl 024, 026, ms270, 260</p>	<p>Kupe freksioni PRO 3/8-7Dh</p> <p>Stihl 029, 034, ms290, ms310/360</p>
<p>21358X</p> <p>OREGON </p>  <p>Çmimi 2.450</p>	<p>108308X</p> <p>OREGON </p>  <p>Çmimi 2.590</p>	<p>29175X</p> <p>OREGON </p>  <p>Çmimi 2.800</p>
<p>Kupe freksioni 3/8", 7 dhëmbë</p> <p>për Dolmar CS-451, CS-452, CS-500</p>	<p>Kupe freksioni PRO 325-7Dh</p> <p>Husqvarna 340, 350, 357, 445</p>	<p>Kupe freksioni PRO 325-7Dh</p> <p>Husqvarna 50, 55</p>

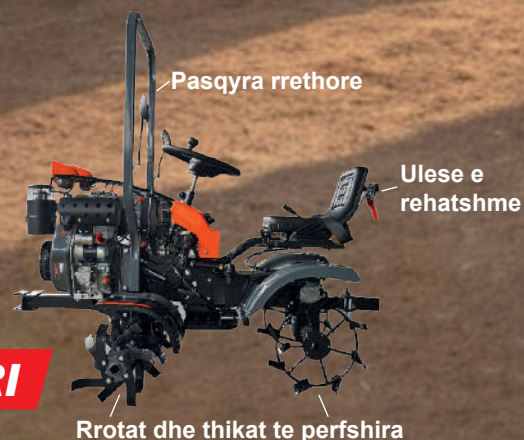

FREZA, TURRJELA DHE SPERKATËSE

IRI

MULTIKULTIVATOR/ TRAKTOR ME NAFTE

- | Motori 11 Hp
- | Ndezje elektrike
- | Gjeresia e punes 1050mm
- | 4 marshe 3+1
- | Goma 5x12 dhe 4x8
- | Set rrotash metalike dhe set thikash 16+16

Kodi MB9300

CMIMI

350.000 LEK

NAKAYAMA
PRO



PLUG TEK

- | Per Multikultivator/
Traktor MB9300

Kodi MB9303

CMIMI

19.900 LEK



PLUG DYSH

- | Per Multikultivator/
Traktor MB9300

Kodi MB9304

CMIMI

29.900 LEK





Funksioni i frezimit dhe punimit te toke



2ne1



MULTIKULTIVATOR 2 NE 1 ME BENZINE

- | Motori 7 Hp/212cc (4 kohe)
- | 2 marsha, 1 para 1 pas
- | Thellesi 580mm
- | Me 12 thika

Kodi MB6510
CMIMI
99.000 LEK

SET ME 2 RROTA METALIKE

- | Per Multikultivator 2 NE 1 MB6510 (rezerve)

Kodi MB6511
CMIMI
7.900 LEK



SET ME 12 THIKA

- | Per Multikultivator 2 NE 1 MB6510 (rezerve)

Kodi MB6512
CMIMI
5.900 LEK



E RE

NAKAYAMA
PRO

FREZE TOKE ME NAFTE

- | Motor me 4 kohe
- | Motori 418 cc / 10 Hp
- | Gjeresia e punimit: 100 - 120 cm
- | Transmisioni 2 marshe perpara - 1 prapa
- | Ndezje elektrike me bateri dhe mbrojtese plastike + timon multifunksional

Kodi MB9005

CMIMI
145.000 LEK



Thika e djathte

Thika e majte



NAKAYAMA
PRO

FREZE TOKE ME NAFTE

- | Motori 418 cc / 10 Hp
- | Gjeresia e punimit: 110 cm
- | Ndezje elektrike me bateri
- | 3 marshe

Kodi MB9000CLASSIC

CMIMI
125.000 LEK



Thika e djathte

Thika e majte

1
2
3
4
5
6
7
8
9
10

**FREZE TOKE
ME BENZINE**

- | Motori 7.5 Hp
- | 4 marshe 2+1
- | Gjeresia e punimit 100cm

Kodi MB7100

**CMIMI
89.000 LEK**

NAKAYAMA
PRO

ERE



Q
V
L



Q
V
L

**FREZE TOKE
ME BENZINE**

- | Motori 196 cc / 6.5Hp
- | Gjeresia e punimit: 90-100 cm
- | Transmisioni 2 marshe perpara
- 1 prapa
- | Rrota 5.00 x 12" Thika 16+16

Kodi MB7000CLASSIC

**CMIMI
59.900 LEK**

NAKAYAMA
PRO

**KULTIVATOR ME
BENZINE 2 NE 1**

- | Motori 196 cc
- | Fuqia 6.5 Hp (4.5 kW)
- | Gjeresia e punimit: 85 mm
- | Goma 3.5-4

Kodi MB6000

**CMIMI
57.500 LEK**

NAKAYAMA
PRO



Q
V
L

E RE



NAKAYAMA
PRO

**FREZE TOKE
ME BENZINE**

- | Motori 4.0 HP, 139cc
- | Gjeresia e punimit: 600 mm
- | 12+12 thika
- | 3 pozicione

Kodi MB5005

**CMIMI
37.900 LEK**

FORCE
MACHINERY - TOOLS

**KULTIVATOR
ME BENZINE**

- | Motori 42.7cc
- | Gjeresia e punimit: 320 mm
- | Me 4 thika
- | Motor me 2 kohe

Kodi WG430

**CMIMI
19.900 LEK**



Q
V
L
L

Einhell

**KULTIVATOR MINI
ME BATERI**

- | Me bateri 18 V GE-CR 18/20
- | Gjeresia e punimit: 20 cm
- | Thellesia e punimit: 20 cm
- | Vetëm trup

Kodi 34.312.10

**CMIMI
11.500 LEK**



STARTER KIT
Set me bateri
18 V / 4.0 + karikues



Art. 45.120.42
CMIMI 7.500 Lek

1
2
3
4
5
6
7
8
9
10

**MOTOKULTIVATOR
ME NAFTE**

- | Motor 178F
- | Fuqia: 6.5 HP
- | Gjeresia e punimit: 97 cm
- Thellesia e punimit: 15 cm
- Marshet: 2 + 2
- Rrota: 4-8

Kodi MF360D

CMIMI
115.000 LEK

FORCE
MACHINERY - TOOLS

DIESEL



GRUP FREZE PER MOTOKULTIVATOR

- | Gjeresia e punimit: 560 mm
- | Thellesia e punimit: 200 mm

Kodi TI360

CMIMI
39.900 LEK



GRUP KORRESE PER MOTOKULTIVATOR

- | Gjeresia e prerjes: 970 mm
- | Lartesia e prerjes max: 20-60 mm

Kodi GC360B

CMIMI
46.900 LEK



RROTA METALIKE+HAPESE VIJASH

- | Rrota: 420 mm
- | Hapese vijash per motokultivator MF360D

Kodi SP360

CMIMI
17.900 LEK

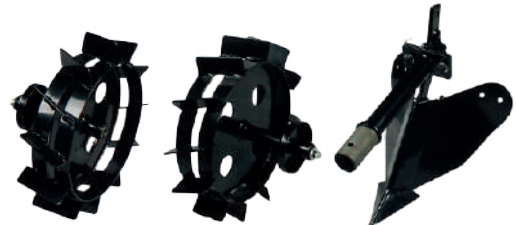

GRUP FREZE PER MOTOKULTIVATOR

- | Gjeresia: 900 mm
- | Per motokultivator MF360D

Kodi SW360

CMIMI
74.900 LEK



**MOTOKULTIVATOR
ME NAFTE**

- | Motor 186F
- | Fuqia: 15 HP
- | Ndezje elektrike
- | Marshet: 3 + 3
- | Rrota: 5-10

Kodi MF380DE

**CMIMI
165.000 LEK**

FORCE
MACHINERY - TOOLS

DIESEL



GRUP FREZE PER MOTOKULTIVATOR

- | Gjerësia e punimit: 560 mm
- | Thellessia e punimit: 200 mm

Kodi T1400

**CMIMI
45.900 LEK**



GRUP KORRESE PER MOTOKULTIVATOR

- | Gjerësia e prerjes: 1200 mm
- | Lartësia e prerjes max: 20-60 mm

Kodi GS400

**CMIMI
49.900 LEK**



SET ME 2 RROTA METALIKE

- | 2 rrota metalike
- | Per motokultivator MF380DE

Kodi MW500

**CMIMI
12.500 LEK**

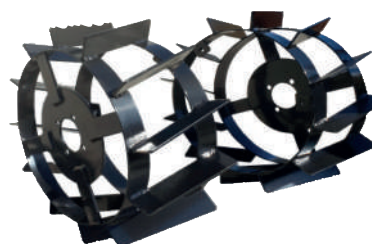

1
2
3
4
5
6
7
8
9
10

SPS400



Çmimi
10.500

SP400



Çmimi
14.500

Plug toke

Per motokultivator MF380DE

Plug toke bashke me grup

Per motokultivator MF380DE

PL400



Çmimi
17.500

SW400



Çmimi
79.900

Plug toke bashke me grup te kompletuar

Per motokultivator MF380DE

Grup fshese pastrimi 1100 mm

Per motokultivator MF380DE

NAKAYAMA
PRO

TRAJLER BUJQESIE PER FREZA

- Per pesha deri ne 500 kg
- Goma 4.00X127, C-0.5Me 4 thika

Kodi MB211

CMIMI
45.000 LEK



McCULLOCH

TRAJLER BUJQESIE

- Per pesha deri ne 150 kg
- Goma 16"

Kodi 577616901

CMIMI
27.500 LEK

IRI





FREZE TOKE ME NAFTE

- | Motor i fuqishem
- | Fuqia 5.2 Hp
- | Marshet -1, 0, 2, 1
- | Gjeresia e punes 1200 mm
- | Thellesia e punes 150 -300 mm

Kodi DC12001

CMIMI
79.500 LEK



FREZE TOKE ME NAFTE

- | Fuqia 7.0 Hp (5.1 kW)
- | Me 2 marshe
- | Gjeresia e punes 1200 mm
- | Thellesia e punes 150 -300 mm

Kodi GC12001

CMIMI
59.500 LEK



KULTIVATOR ME BENZINE

- | Fuqia 6.5 Hp (4.5 kW)
- | Gjeresia e punimit: 900 mm
- | Thellesia e punimit: 150-300 mm

Kodi GC6101

CMIMI
49.900 LEK



TURRJELE TOKE ME BATERI

- | Motor pa karboncina per jetegjatesi sherbimi
- | Multifunksionale mund te perdoret dhe si perzjerese kolli
- | Fale lirise qe ju ofron bateria mund te punoni dhe larg rrjetit elektrik
- | Trup celiku i fuqishem



Einhell

TURRJELE MULTIFUNKSIONALE ME BATERI

- | Tensioni 18 V
- | Motor pa karboncina
- | 3 mënyra të ndryshme: në drejtim të kundërt, në drejtim të akrepave të orës: ECO & LARTË FUQI
- | Vetem trup

Kodi 34.370.00

CMIMI
19.000 LEK



Einhell

TURRJELE SHPUESE

- | GP-EA
- | Diametri 120 mm
- | Gjatesia 80 cm

Kodi 34.370.10

CMIMI
4.500 LEK



Einhell

SHUFER PERZJERERE KOLLI PER TURRJELEN ME BATERI

- | GP-EA
- | Diametri 120 mm

Kodi 34.370.11

CMIMI
2.290 LEK



Einhell

ZGJATUES PER TURRJELE TOKE

- | Gjatesia 1 m

Kodi 34.370.12

CMIMI
1.900 LEK



**TURRJELE TOKE
ME BATERI 20 V**

- | Motori pa karboncina
- | Fuqia 20V/4.0Ah
- | + Turrjele 80 cm

Kodi CEALI208011

**CMIMI
14.500 LEK**



**TURRJELE TOKE
ME BENZINE**

- | Motori 1E48F
- | Fuqia 2.2 kW
- | Madhesia motorit 63.3 cc
- | Kap. turrjeles 300 mm

Kodi DZ64S

**CMIMI
25.500 LEK**



**TURRJELE TOKE
ME BENZINE**

- | Motori 1E44F-5A
- | Fuqia 1.4 kW
- | Madhesia motorit 51.7 cc
- | Kap. turrjeles 200 mm

Kodi DZ52

**CMIMI
17.500 LEK**

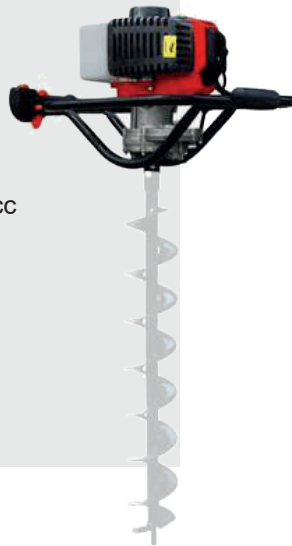

**TURRJELE TOKE
ME BENZINE**

- | Motori 1E40/F-5A
- | Fuqia 1.25 kW
- | Madhesia motorit 42.7 cc
- | Kap. turrjeles 150 mm

Kodi DZ43

**CMIMI
14.500 LEK**

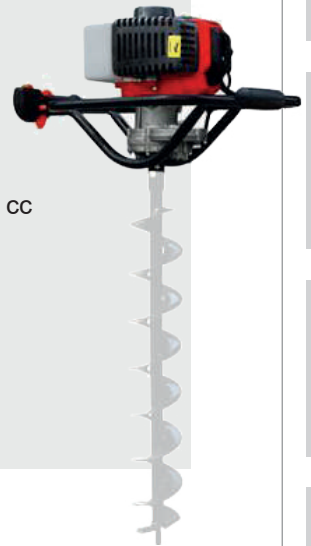

FORCE
MACHINERY - TOOLS



Turrjele shpuese

Kodi	Permasa	Cmimi
DB80	80 mm	4.100
DB100	100 mm	4.300

FORCE
MACHINERY - TOOLS



Turrjele shpuese

Kodi	Permasa	Cmimi
DB150	150 mm	4.500
DB200	200 mm	4.900

FORCE
MACHINERY - TOOLS



Turrjele shpuese

Kodi	Permasa	Cmimi
DB250	250 mm	5.900
DB300	300 mm	8.500

1
2
3
4
5
6
7
8
9
10

POMPA SPËRKATËSE ME BATERI

KU PËRDOREN POMPAT ME BATERI?

MBROJTJA E BIMËVE

- në ambiente të mëdha
- në serra / ferma / pemishte
- për pemë / bimë / lule
- kontrolli i barërave të këqija
- mbrojtje ndaj dëmtuesve
- mbrojtje ndaj sëmundjeve

- 1** Pompë e përshtatshme për të gjitha lëndët e lengshme
- 2** Grykë e gjërë mbushjeje
- 3** Shkop plastik rezistent 50 cm
- 4** Manometer për matjen e presionit
- 5** Fuçi me material plastik UV Lidhëse dhe mbajtëse komfote
- 6** Pompë elektrike me dy opsione për rregullimit e presionin dhe volumit
- 7** Bateri e fuqishme Lead Gel Rezistente
- 8** Tub 1.5 metra
- 9** Bateri 12V/8Ah



WXDD-16D

Presioni 0.2-0.4
Depozita 16 Lt

3.500 Lek



WXDD-18D

Presioni 0.2-0.4
Depozita 18 Lt

3.700 Lek



WXDD-20D

Presioni 0.2-0.4
Depozita 20 Lt

3.900 Lek

NS2630

NAKAYAMA



Çmimi
6.500

Sperkatese shpine me bateri

Bateria 9 V
Nr xhirove 4000-10000 rpm
Depozita 5 lt+1 lt

34.252.40

Einhell



Çmimi
5.500

Sperkatese dore me bateri

Bateria 18V (vetem trup)
Depozita 1 L, Presioni 1.3 bar

3WF-3C

FORCE
MACHINERY - TOOLS



Çmimi
8.900

Sperkates / Dezifektues

Me benzine Motori WX-3C
Depozita 14 L

NS2631

NAKAYAMA



Çmimi
9.900

Sperkatese shpine me bateri

Bateria 9 V
Nr xhirove 4000-10000 rpm
Depozita 5 lt+1 lt

WX768

FORCE
MACHINERY - TOOLS



Çmimi
9.900

Sperkatese shpine me benzine

Motori me 2 kohe 26 cc / 0.65 kW
Depozita 25 Lt
Prurja max 5-7lt/min

3WF-3A

FORCE
MACHINERY - TOOLS



Çmimi
8.900

Sperkates / Dezifektues

Me benzine Motori WX-3A
Depozita 26 L

1
2
3
4
5
6
7
8
9
10

WX168F1-30A
FORCE
 MACHINERY - TOOLS

 Çmimi
24.900
Sperkatese ilaci me karroce

 Motorri HONDA 6.5 hp
 Prurja 35 l/min
 Tubi 100 m 8.5 mm

WX168F1-30B
FORCE
 MACHINERY - TOOLS

 Çmimi
24.900
Sperkatese ilaci me karroce

 Motorri HONDA 168F
 Fuqja 6.5 Hp
 Prurja 35 l/min Tubi 100 m 8.5

NS4010
NAKAYAMA
 PRO

 Çmimi
29.900
Sperkatese ilaci

 Motorri 6.5 hp
 Prurja 22 l/min
 Presioni 45 bar

NS5210
NAKAYAMA
 PRO

 Çmimi
35.900
Sperkatese ilaci me karroce

 Motorri me 2 kohe 26 cc
 Depozita 50 lt
 Tubi 30 m 8.5 mm

Grup pompe sperkatese me 3 piston
FORCE
 MACHINERY - TOOLS

E RE

Kodi	Te dhena	Çmimi
WX22A-1	22lt/min, 45 Bar, 2HP	6.500
WX28A-1	37lt/min, 45 Bar, 5HP	7.900

11130-30
GARDENA
MADE IN GERMANY

 Çmimi
3.790
Sperkatese Mekanike

Depozita 5 Lt

NS5000
NAKAYAMA
 PRO

 Çmimi
1.590
Sperkatese mekanike

Depozita 5 L

NS8000
NAKAYAMA
 PRO

 Çmimi
1.900
Sperkatese Mekanike

Depozita 8 L

NS1602
NAKAYAMA
 PRO

 Çmimi
2.550
Sperkatese mekanike

Depozita 16 L

HSPP30102

INGCO

ERE

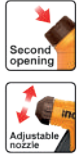

Çmimi
990

Sperkatese mekanike

Depozita 1 L

HSPP20202

INGCO



Çmimi
650

Sperkatese mekanike

Depozita 2 L

HSPP30502

INGCO



Çmimi
1.450

Sperkatese Mekanike

Depozita 5 L

HSPP30802

INGCO

ERE



Çmimi
1.690

Sperkatese Mekanike

Depozita 8 L

HSPP41602

INGCO



Çmimi
2.690

Sperkatese mekanike

Depozita 16 L

HSPP42002

INGCO

ERE



Çmimi
2.990

Sperkatese mekanike

Depozita 20 L

WKS1516

WAPFOW

ERE



Çmimi
2.500

Sperkatese Shpine

Depozita 16 Lt

WX-1.5LA

**FORCE
MACHINERY - TOOLS**

ERE



Çmimi
350

Sperkatese dore plastike

Depozita 1.5 L

WX-2.0LA

**FORCE
MACHINERY - TOOLS**

ERE













Çmimi
450

Sperkatese dore plastike

Depozita 2 L

1
2
3
4
5
6
7
8
9
10

<p>49439</p>  <p>solo</p> <p>Çmimi 550</p>	<p>49445</p>  <p>solo</p> <p>Çmimi 750</p>	<p>49449</p>  <p>solo</p> <p>Çmimi 950</p>
<p>Steke sperkatese</p> <p>Gjatesia 50 cm Hundes e sheshte</p>	<p>Zgjatues steke teleskopike</p> <p>Gjatesia 120-130 cm Materiali Karbon</p>	<p>Steke sperkatese</p> <p>Gjatesia 120 cm Materiali Fibra karboni</p>
<p>49513</p>  <p>solo</p> <p>Çmimi 390</p>	<p>49450</p>  <p>solo</p> <p>Çmimi 550</p>	<p>49478</p>  <p>solo</p> <p>Çmimi 950</p>
<p>Zgjatues steke sperkatje</p> <p>Gjatesia 50 cm Materiali Plastik</p>	<p>Zgjatues steke fleksibel</p> <p>Gjatesia 15 cm Materiali Plastik</p>	<p>Zgjatues steke teleskopike</p> <p>Gjatesia 57-100 cm Materiali Bronz</p>
<p>49428</p>  <p>solo</p> <p>Çmimi 550</p>	<p>49528</p>  <p>solo</p> <p>Çmimi 990</p>	<p>NS105</p>  <p>NAKAYAMA PRO</p> <p>Çmimi 750</p>
<p>Zgjatues steke sperkatje</p> <p>Gjatesia 75 cm Materiali Bronz</p>	<p>Zgjatues steke dyshe</p> <p>Gjatesia 150 cm Materiali Bronz</p>	<p>Steke sperkatese</p> <p>Gjatesia 60 cm Materiali Metalike</p>
<p>NS104</p>  <p>NAKAYAMA PRO</p> <p>Çmimi 2.900</p>	<p>NS106</p>  <p>NAKAYAMA PRO</p> <p>Çmimi 590</p>	<p>NS108</p>  <p>NAKAYAMA PRO</p> <p>Çmimi 1.690</p>
<p>Steke sperkatese</p> <p>Gjatesia 60 cm Materiali Metalike</p>	<p>Steke sperkatese</p> <p>Gjatesia 60 cm Materiali Plastike</p>	<p>Steke sperkatese</p> <p>Gjatesia 60 cm Materiali Bronzi</p>

NS130



Çmimi

890

NS131



Çmimi

990

Steke sperkatese Turbo



Steke sperkatese

Gjatesia 60 cm
Materiali Metalike

Steke sperkatese

Gjatesia 90 cm
Materiali Metalike

Kodi	Te dhena	Çmimi
NS132	30 cm / bronz	1.790
NS133	60 cm / .bronz	2.200

FS99

ERE



Çmimi

290

WXC01



Çmimi

750

WXC02



Çmimi

790

Steke per sperkatese me bateri

Per sperkatese 16, 18, 20 Lt
Material Metalike

Steke sperkatese

Gjatesia 30 cm
Doreze metalike

Steke sperkatese

Gjatesia 30 cm
Doreze Bronzi

WXC03



Çmimi

450

WXC12



Çmimi

550

WXC22



Çmimi

990

Steke sperkatese

Gjatesia 30 cm
Doreze Bronzi

Steke sperkatese

Gjatesia 30 cm
Doreze Bronzi

Steke sperkatese e drejte

Gjatesia 60 cm
Materiali Bronz

10101



Çmimi

100

NS103



Çmimi

350

NS109



Çmimi

250

Koke sperkatese

Materiali Bronz

Adaptor lidhes flutur

Φ 8

Rakorderi e shpejte femer

1/2" per sperkatese

10112

FORCE
MACHINERY - TOOLS



Çmimi
59

10114

FORCE
MACHINERY - TOOLS



Çmimi
69

10115

FORCE
MACHINERY - TOOLS



Çmimi
79

Koke sperkatese

Materiali Plastike

Koke sperkatese dyshe

Materiali Plastike

Koke sperkatese dyshe

Materiali Plastike
Dopio filetim

10125

FORCE
MACHINERY - TOOLS



Çmimi
59

10126

FORCE
MACHINERY - TOOLS



Çmimi
59

10181

FORCE
MACHINERY - TOOLS



Çmimi
190

Koke sperkatese e drejte

Materiali Plastike
Filetimi Mashkull

Koke sperkatese e drejte

Materiali Plastike
Filetimi Femer

Doreze steke sperkatese

Materiali Plastike
Perdorimi Universal

WX-103

FORCE
MACHINERY - TOOLS



Çmimi
6.900

WX-102

FORCE
MACHINERY - TOOLS

IRI



Çmimi
7.900

WX-BS128

FORCE
MACHINERY - TOOLS



Çmimi
1.490

Tub sperkatese

Gjatesia 100 m
Diametri 8.5 mm 140 bar

Tub sperkatje me presion

Gjatesia 100 m
Diametri 8.5 mm

Bateri per sperkatese shpine

Bateria 12 V / 8.0 Ah

WX-KS128

FORCE
MACHINERY - TOOLS



Çmimi
450

WKW1815

WADFOW



Çmimi
350

WKW1850

WADFOW



Çmimi
690

Karikues

Per sperkatese shpine 12 V / 8.0 Ah

Kane uji plastike

Depozita 1.5 Lt

Kane uji plastike

Depozita 5.0 Lt



**POMPA UJI, MOTOPOMPA
DHE GJENERATORE**



KPM50



Pompe volumetrike

Fuqia 0.37 kW
Hedhja max. H=34 m
Prurja max. Q=35 l/min

KPM80



Pompe volumetrike

Fuqia 0.6 kW
Hedhja max. H=59 m
Prurja max. Q=50 l/min

CM22



Pompe centrifugale

Fuqia 0.37 kW
Hedhja max. H=20 m
Prurja max. Q=100 l/min

CM32/BR



Pompe centrifugale

Fuqia 0.75 kW
Hedhja max. H=29 m
Prurja max. Q=125 l/min

CM35



Pompe centrifugale

Fuqia 1.15 kW
Hedhja max. H=36 m
Prurja max. Q=125 l/min

CAM40



Pompe presioni

Fuqia 0.6 kW
Hedhja max. H=38 m
Prurja max. Q=50 l/min

CAM75



Pompe presioni

Fuqia 0.6 kW
Hedhja max. H=42 m
Prurja max. Q=50 l/min

CAM100



Pompe presioni

Fuqia 0.75 kW
Hedhja max. H=45 m
Prurja max. Q=60 l/min

CAM130



Pompe presioni

Fuqia 1.0 kW
Hedhja max. H=47 m
Prurja max. Q=60 l/min



CAM80



MADE IN ITALY

Çmimi
17.900

Pompe presioni, trup inoxi

Fuqia 0.6 kW
Hedhja max. H=38 m
Prurja max. Q=50 l/min

2CM25/160C

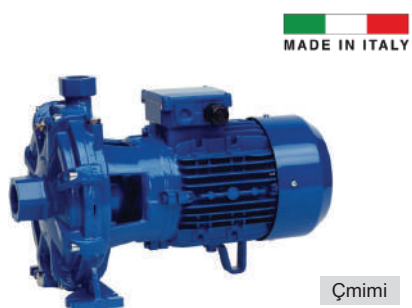

MADE IN ITALY

Çmimi
43.900

Pompe centrifugale me 2 helika

Fuqia 1.1 kW / 230v
Hedhja max. H=51 m Q=160 l/min
Dalja e pompes 1" 1/4

CBM303



MADE IN ITALY

Çmimi
49.900

Pompe centrifugale per vadtjte

Fuqia 2.2 kW
Hedhja max. H=17 m
Prurja max. Q=1000 l/min
Dalja e pompes 3"

APM100



MADE IN ITALY

Çmimi
29.900

Pompe me 2 thithje

Fuqia 0.75 kW
Hedhja max. H=36 m Q=35 l/min
Lartesia max. H=30 m

2CM25/160B

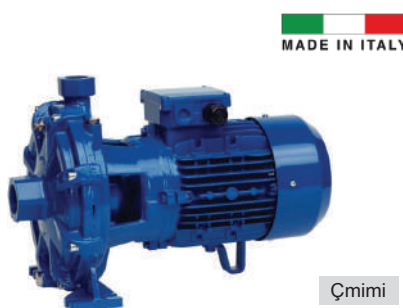

MADE IN ITALY

Çmimi
43.900

Pompe centrifugale me 2 helika

Fuqia 1.5 kW / 230v
Hedhja max. H=58 m Q=160 l/min
Dalja e pompes 1" 1/4

RVM4



MADE IN ITALY

Çmimi
29.000

Pompe centrifugale vertikale

Fuqia 0.75 kW
Hedhja max. H=46 m
Prurja max. Q=90 l/min
Dalja e pompes 1"

APM150



MADE IN ITALY

Çmimi
43.900

Pompe me 2 thithje

Fuqia 1.1 kW
Hedhja max. H=43 m / Q=35 l/min
Lartesia max. H=46 m

CBM203



MADE IN ITALY

Çmimi
49.000

Pompe centrifugale per vadtjte

Fuqia 1.5 kW
Hedhja max. H=16 m
Prurja max. Q=900 l/min
Dalja e pompes 3"

PM20



MADE IN ITALY

Çmimi
21.500

Pompe ushqimore

Fuqia 0.37 kW
Hedhja max. H=14 m
Prurja max. Q=25 l/min
Dalja e pompes Ø 20 mm

PM25



Çmimi

29.900

Pompe ushqimore

Fuqia 0.75 kW
Hedhja max. H=19 m
Prurja max. Q=55 l/min
Dalja e pompes Ø 25 mm

RSM4



Çmimi

25.900

Pompe centrifugale horizontale

Fuqia 0.75 kW
Hedhja max. H=45 m
Prurja max. Q=90 l/min
Dalja e pompes 1"

RSM5



Çmimi

29.500

Pompe centrifugale horizontale

Fuqia 1.1 kW
Hedhja max. H=60 m
Prurja max. Q=90 l/min
Dalja e pompes 1"

SMC1103



Çmimi

31.900

Pompe zhytëse inoksi per puse

Fuqia 1.0 kW
Hedhja max. H=38 m
Prurja max. Q=120 l/min
Thellesia max e zhytjes. H=10 m

TSN300/S



Çmimi

14.500

Pompe zhytëse

Fuqia 0.3 kW
Hedhja max. H=6.5 m
Prurja max. Q=90 l/min
Thellesia max e zhytjes. H=5 m

TFE1000/S



Çmimi

24.900

Pompe zhytëse ujra te ndotura

Fuqia 1.0 kW
Hedhja max. H=11 m
Prurja max. Q=240 l/min
Thellesia max e zhytjes. H=5 m

SDC200



Per uje te paster

Çmimi

9.900

Pompe zhytëse

Fuqia 0.20 kW
Hedhja max. H=5 m
Prurja max. Q=60 l/min
Thellesia max e zhytjes. H=5 m

SDC300



Me galixhant elektrik

Per uje te paster

Çmimi

11.500

Pompe zhytëse

Fuqia 0.3 kW
Hedhja max. H=7 m
Prurja max. Q=100 l/min
Thellesia max e zhytjes. H=5 m

SDC550G



Me galixhant elektrik

Per uje te paster

Çmimi

12.500

Pompe zhytëse

Fuqia 0.55 kW
Hedhja max. H=8 m
Prurja max. Q=165 l/min
Thellesia max e zhytjes. H=5 m

SVC400



Per uje te ndotur

Çmimi

11.500

Pompe zhytесе uja te ndotura

Fuqia 0.4 kW
Hedhja max. H=7 m
Prurja max. Q=140 l/min
Thellesia max e zhytjes. H=5 m

SVC900



Per uje te ndotur

Çmimi

14.500

Pompe zhytесе uja te ndotura

Fuqia 0.9 kW
Hedhja max. H=9 m
Prurja max. Q=230 l/min
Thellesia max e zhytjes. H=5 m

SDX400



Per uje te paster

Çmimi

14.900

Pompe zhytесе inoxi

Fuqia 0.4 kW
Hedhja max. H=7 m
Prurja max. Q=110 l/min
Thellesia max e zhytjes. H=5 m

SDX1100



Per uje te paster

Çmimi

21.900

Pompe zhytесе inoxi

Fuqia 1.1 kW
Hedhja max. H=9 m
Prurja max. Q=280 l/min
Thellesia max e zhytjes. H=5 m

SVX550



Per uje te ndotur

Çmimi

19.900

Pompe zhytесе uja te ndotura

Fuqia 0.55 kW
Hedhja max. H=7 m
Prurja max. Q=180 l/min
Thellesia max e zhytjes. H=5 m

SVX1100



Per uje te paster

Çmimi

22.500

Pompe zhytесе uja te ndotura

Fuqia 1.1 kW
Hedhja max. H=10 m
Prurja max. Q=250 l/min
Thellesia max e zhytjes. H=5 m

41.707.42



Çmimi

9.500

Pompe zhytесе inoxi

Per uja te pista
Fuqia 1300 W / 230v
Hedhja max. H=10 m
Q= 23000 l/h

41.704.45



Çmimi

7.900

Pompe zhytесе

Per uja te pista
Fuqia 350 W / 230v
Hedhja max. H=7.5 m
Q= 8000 l/h

NP1120



Çmimi

16.900

Pompe zhytесе

Per uja te paster
Fuqia 1.0 kW / 230v
Hedhja max. H=40 m
Q= 6.500 l/min

**POMPE USHQIMORE
NOVAX 14-M**

- | Fuqia 480 W / 0.6 Hp
- | Prurja max. 14 Lt/min
- | Hedhja max. 12 m
- | Diameter 14 mm
- | Per varja

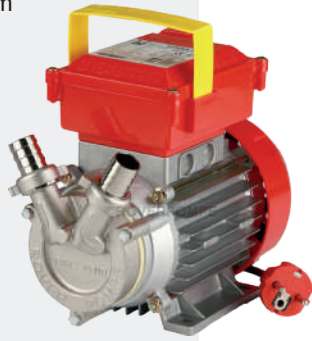
Kodi 800000
**CMIMI
19.000 Lek**

**POMPE USHQIMORE
NOVAX 20-B**

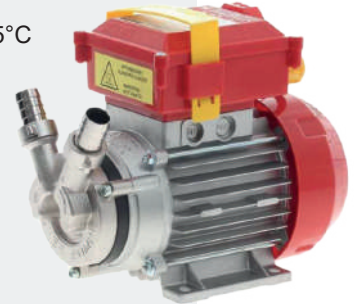
- | Fuqia 0.50 Hp
- | Prurja max. 28 Lt/min
- | Hedhja max. 25 m
- | Diameter 20 mm
- | Per lengje deri 95°C

Kodi 964000 220
**CMIMI
18.500 Lek**

**POMPE USHQIMORE
NOVAX 25-B**

- | Fuqia 660 W / 0.90 Hp
- | Prurja max. 45 Lt/min
- | Hedhja max. 10 m
- | Diameter 25 mm
- | Per lengje deri 95°C

Kodi 939000
**CMIMI
25.900 Lek**

**POMPE USHQIMORE
NOVAX 30-B**

- | Fuqia 1000 W / 1.20 Hp
- | Prurja max. 85 Lt/min
- | Hedhja max. 10 m
- | Diameter 30 mm
- | Per lengje dhe vajra deri ne 95°C



Kodi 938000
**CMIMI
34.900 Lek**

**POMPE USHQIMORE
NOVAX 25-M**

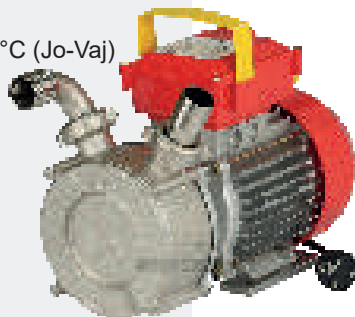
- | Fuqia 375 W / 0.9 Hp
- | Prurja max. 45 Lt/min
- | Hedhja max. 12 m
- | Diameter 25 mm
- | Per lengje deri 35°C (Jo-Vaj)

Kodi 998000
**CMIMI
26.900 Lek**

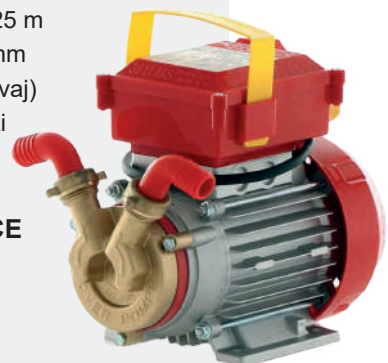
**POMPE USHQIMORE
ROVER 20**

- | Fuqia 360 W / 0.5 Hp
- | Prurja max. 28 Lt/min
- | Hedhja max. 25 m
- | Diameter 25 mm
- | Per lengje (jo-vaj)
- | Material bronzi

Kodi 300000 CE
**CMIMI
10.900 Lek**

**POMPE USHQIMORE
ROVER 25**



- | Fuqia 590 W / 0.8 Hp
- | Prurja max. 40 Lt/min
- | Hedhja max. 25 m
- | Diameter 25 mm
- | Per lengje (jo-vaj)
- | Material bronzi



Kodi 540000 CE

**CMIMI
14.500 Lek**

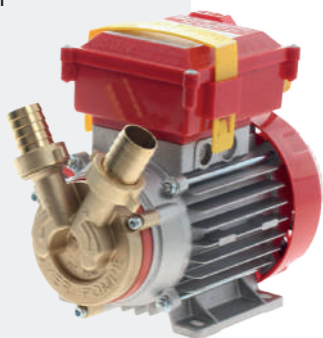

**POMPE USHQIMORE
ROVER 30 CE**



- | Fuqia 1 Hp
- | Prurja max. 75 Lt/min
- | Hedhja max. 20 m
- | Diameter 30 mm
- | Per lengje (jo-vaj)
- | Material bronzi



Kodi 965000

**CMIMI
19.900 Lek**

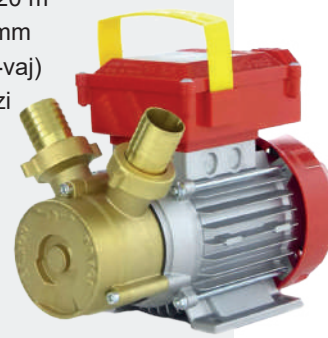

**POMPE USHQIMORE
ROVER 40**



- | Fuqia 1 Hp
- | Prurja max. 110 Lt/min
- | Hedhja max. 27 m
- | Diameter 20 mm
- | Per lengje (jo-vaj)
- | Material bronzi



Kodi 110000 CE

**CMIMI
26.500 Lek**

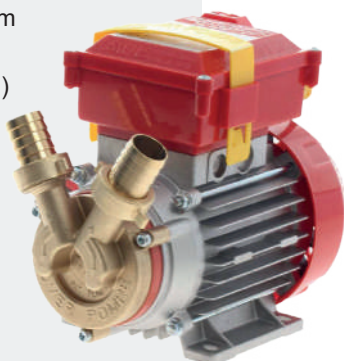

**POMPE USHQIMORE
NOVAX 20-M**



- | Fuqia 0.5 Hp
- | Prurja max. 28 Lt/min
- | Hedhja max. 27 m
- | Diameter 20 mm
- | Per lengje (jo-vaj)



Kodi 790000

**CMIMI
16.500 Lek**

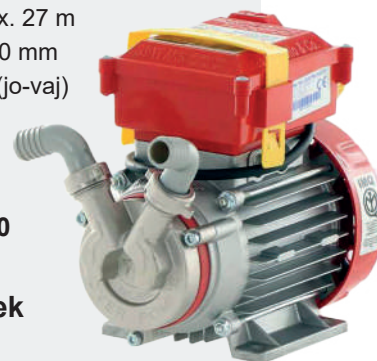

**POMPE USHQIMORE
NOVAX 40-M**



- | Fuqia 1.2 Hp
- | Prurja max. 110 Lt/min
- | Hedhja max. 15 m
- | Diameter 40 mm
- | Per lengje (jo-vaj)



Kodi 750000

**CMIMI
38.500 Lek**

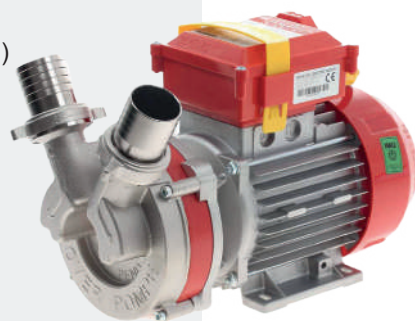

**POMPE USHQIMORE
NOVAX G 20 INOX**



- | Fuqia 480 W / 0.6 Hp
- | Prurja max. 14 Lt/min
- | Hedhja max. 12 m
- | Diameter 14mm
- | Per vaj dhe lengje deri ne 35°C



Kodi 972000 I

**CMIMI
33.000 Lek**



FB60



Çmimi
4.500

Pompe volumetrike

Fuqia 0.37 kW / 220 volt
Lartesia max. H=35 m
Prurja max. Q=35 l/min

FB70



Çmimi
6.900

Pompe volumetrike

Fuqia 0.55 kW / 220 volt
Lartesia max. H=48 m
Prurja max. Q=45 l/min

FB80



Çmimi
8.900

Pompe volumetrike

Fuqia 0.75 kW / 220 volt
Lartesia max. H=53 m
Prurja max. Q=45 l/min

FGP125T



Çmimi
7.500

Pompe vakumi

Fuqia 0.37 kW / 220 volt
Lartesia max. H=35 m
Prurja max. Q=35 l/min

FGP125



Çmimi
6.900

Pompe vakumi

Fuqia 0.37 kW / 220 volt
Lartesia max. H=35 m
Prurja max. Q=35 l/min

FCP130



Çmimi
8.500

Pompe centrifugale

Fuqia 0.37 kW / 220 volt
Lartesia max. H=20 m
Prurja max. Q=72 l/min

FCP146



Çmimi
9.900

Pompe centrifugale

Fuqia 0.55 kW / 220 volt
Lartesia max. H=25 m
Prurja max. Q=105 l/min

FCP158



Çmimi
11.500

Pompe centrifugale

Fuqia 0.75 kW / 220 volt
Lartesia max. H=30 m
Prurja max. Q=100 l/min

FCP170



Çmimi
13.900

Pompe centrifugale

Fuqia 1.1 kW / 220 volt
Lartesia max. H=38/ m
Prurja max. Q=120 l/min

FCP200



Çmimi
14.900

Pompe centrifugale

Fuqia 1.5 kW / 220 volt
Lartesia max. H=41 m
Prurja max. Q=120 l/min

FJSW/6M



Çmimi
9.900

Pompe presioni

Fuqia 0.37 kW / 220 volt
Lartesia max. H=29 m
Prurja max. Q=55 l/min

FJSW/10M



Çmimi
11.500

Pompe presioni

Fuqia 0.75 kW / 220 volt
Lartesia max. H=34 m
Prurja max. Q=70 l/min

FET100

 Çmimi
11.500
Pompe presioni

 Fuqia 0.75 kW / 220 volt
 Lartesia max. H=40 m
 Prurja max. Q=50 l/min

FET150

 Çmimi
17.900
Pompe presioni

 Fuqia 1.1 kW / 220 volt
 Lartesia max. H=55 m
 Prurja max. Q=80 l/min

FET200

 Çmimi
19.900
Pompe presioni

 Fuqia 1.5 kW / 220 volt
 Lartesia max. H=50 m
 Prurja max. Q=130 l/min

FTQB60

 Çmimi
11.900
Grup presioni automatik

 Fuqia 0.37 kW / 230 volt
 Lartesia max. H=35 m
 Prurja max. Q=35 l/min

FGJ800

 Çmimi
10.500
Pompe presioni inoxi

 Fuqia 0.8 kW / 220 volt
 Lartesia max. H=46 m
 Prurja max. Q=50 l/min

SP1210

 Çmimi
2.990
Pompe cekine me bateri

 Fuqia 80 W
 Lartesia max. H=5 m
 Prurja max. 4000 Lt/ore

FGDA-37

 Çmimi
8.900
INOKS
Pompe Zhytесе 4''+10m kabull

 Fuqia 0.37 kW / 230 Volt
 Hedhja max. H=80 m
 Prurja max. Q=30 l/min

FGDA-50

 Çmimi
9.900
INOKS
Pompe Zhytесе 4''+10m kabull

 Fuqia 0.50 kW / 230 Volt
 Hedhja max. H=80 m
 Prurja max. Q=41 l/min

FGDA-75

 Çmimi
11.500
INOKS
Pompe Zhytесе 4''+10m kabull

 Fuqia 0.75 kW / 230 Volt
 Hedhja max. H=130 m
 Prurja max. Q=30 l/min

4FKM-75

 Çmimi
14.900
INOKS
Pompe Zhytесе 4''+20m kabull

 Fuqia 0.75 kW / 230 Volt
 Hedhja max. H=61 m
 Prurja max. Q=42 l/min

4FKM-1.1

 Çmimi
18.900
INOKS
Pompe Zhytесе 4''+30m kabull

 Fuqia 1.1 kW / 230 Volt
 Hedhja max. H=99 m
 Prurja max. Q=42 l/min

4FKM-1.5

 Çmimi
22.500
INOKS
Pompe Zhytесе 4''+40m kabull

 Fuqia 1.5 kW / 230 Volt
 Hedhja max. H=140 m
 Prurja max. Q=58 l/min

4FRM405-K



Çmimi

14.500

INOKS

Pompe Zhytесе 4"+20m kabull

Fuqia 0.37 kW / 220 Volt
Hedhja max. H=63 m, 5 helika
Prurja max. Q=55 l/min

FK-0.37



Çmimi

1.190

Kuader Elektrik

Fuqia 0.37 kW
Tensioni 230 Volt

4FRM414-K



Çmimi

28.500

INOKS

Pompe Zhytесе 4"+40m kabull

Fuqia 1.1 kW / 220 Volt
Hedhja max. H=112 m, 14 helika
Prurja max. Q=72 l/min

FK-1.1



Çmimi

1.490

Kuader Elektrik

Fuqia 1.1 kW
Tensioni 230 Volt

4FRM408-K



Çmimi

14.900

INOKS

Pompe Zhytесе 4"+30m kabull

Fuqia 0.55 kW / 220 Volt
Hedhja max. H=84 m, 8 helika
Prurja max. Q=55 l/min

FK-0.55



Çmimi

1.290

Kuader Elektrik

Fuqia 0.55 kW
Tensioni 230 Volt

4FRM419-K



Çmimi

29.900

INOKS

Pompe Zhytесе 4"+50m kabull

Fuqia 1.5 kW / 220 Volt
Hedhja max. H=197 m, 19 helika
Prurja max. Q=100 l/min

FK-1.5



Çmimi

1.590

Kuader Elektrik

Fuqia 1.5 kW
Tensioni 230 Volt

4FRM410-K



Çmimi

17.500

INOKS

Pompe Zhytесе 4"+30m kabull

Fuqia 0.75 kW / 220 Volt
Hedhja max. H=105 m, 10 helika
Prurja max. Q=55 l/min

FK-0.75



Çmimi

1.450

Kuader Elektrik

Fuqia 0.75 kW
Tensioni 230 Volt

4FRM426-K



Çmimi

39.900

INOKS

Pompe Zhytесе 4"+50m kabull

Fuqia 2.2 kW / 380 Volt
Hedhja max. H=260 m, 26 helika
Prurja max. Q=133 l/min

FK-2.2



Çmimi

1.690

Kuader Elektrik

Fuqia 2.2 kW
Tensioni 230 Volt

FFS-2

FORCE
 MACHINERY - TOOLS

Çmimi

890
FFS-3

FORCE
 MACHINERY - TOOLS

Çmimi

990
FFS-5

FORCE
 MACHINERY - TOOLS

Çmimi

1.450
Galixhant pompe elektrike

 Kabulli 2 m
 Tensioni 230 Volt

FORCE
 MACHINERY - TOOLS

Kabull Petashuk

Çmimi/m

125FCM-55	4x1.5 mm	139
125FCM-75	4x2.0 mm	169
125FCM-1.1	4x2.5 mm	290

FXH-2540

FORCE
 MACHINERY - TOOLS

Çmimi

890
Set xhunduese

Permasa : 25 mm x 40 cm

007111770

SPERONI
 WATER PUMPS

MADE IN ITALY



Çmimi

6.500
Regullator presioni per pompa

 Per pompa deri ne 1.1 kW
 Lidhja 1" M, Shkalla e izolimit IP54

Galixhant pompe elektrike

 Kabulli 3 m
 Tensioni 230 Volt

FNC-1K

FORCE
 MACHINERY - TOOLS

Çmimi

4.500
Presostat pompe automatik

 Fuqia 1.1 kW
 Presioni 10 bar

FPS9A

FORCE
 MACHINERY - TOOLS

Çmimi

990
Presostat Presioni me kabell

 Tensioni 230 Volt
 Presioni 0.05 - 0.15 Bar

FA250
SPERONI
 WATER PUMPS

MADE IN ITALY



Çmimi

3.990
Filter uji

250 mm / 3.5 Bar

Galixhant pompe elektrike

 Kabulli 5 m
 Tensioni 230 Volt

FNC-1

FORCE
 MACHINERY - TOOLS

Çmimi

3.990
Presostat pompe automatik

 Fuqia 1.1 kW
 Presioni 10 bar

PM5-F
SPERONI
 WATER PUMPS

MADE IN ITALY



Çmimi

1.250
Presostat Presioni

 Me rregullim presioni 1.6-3.2 bar
 Lidhja 1/4" Femer
 Shkalla e izolimit IP44

CF250
SPERONI
 WATER PUMPS

MADE IN ITALY



Çmimi

1.350
Kartuce rrjete per filtra uji

63 mm - 243 mm

 1
2
3
4
5
6
7
8
9
10

VPM37018



**SUPER
SELECT**

Çmimi
4.500

Pompe volumetrike silencioze

Fuqia 370 W
Hedhja max. H=30 m
Prurja max. Q=30 l/min

VPM3708



Çmimi
4.500

Pompe volumetrike

Fuqia 370 W
Hedhja max. H=35 m
Prurja max. Q=35 l/min

VPMS37082

Stainless steel
pump head



Çmimi
8.500

Pompe volumetrike, trup inoxi

Fuqia 370 W
Hedhja max. H=35 m
Prurja max. Q=35 l/min

VPM5508



Çmimi
7.500

Pompe volumetrike

Fuqia 550 W
Hedhja max. H=45 m
Prurja max. Q=45 l/min

VPM7508



Çmimi
7.500

Pompe volumetrike

Fuqia 750 W
Hedhja max. H=52 m
Prurja max. Q=50 l/min

JP07508



Çmimi
9.900

Pompe presioni

Fuqia 750 W
Hedhja max. H=51 m
Prurja max. Q=55 l/min

JP11008



Çmimi
11.900

Pompe presioni

Fuqia 1100 kW
Hedhja max. H=60 m
Prurja max. Q=70 l/min

JP15008



Çmimi
14.900

Pompe presioni

Fuqia 1500 W
Hedhja max. H=60 m
Prurja max. Q=100 l/min

CPM3708



Çmimi
6.900

Pompe centrifugale

Fuqia 370 W
Hedhja max. H=18 m
Prurja max. Q=80 l/min

CPM5508



Çmimi
9.900

Pompe centrifugale

Fuqia 550 W
Hedhja max. H=25 m
Prurja max. Q=100 l/min

CPM7508



Çmimi
9.900

Pompe centrifugale

Fuqia 750 W
Hedhja max. H=30 m
Prurja max. Q=110 l/min

CPM15008



Çmimi
16.900

Pompe centrifugale

Fuqia 1500 W
Hedhja max. H=45 m
Prurja max. Q=140 l/min

MHF150008

E RE

 Çmimi
14.500
Pompe vaditje 2"

 Fuqia 1500 W / 2 Hp
 Hedhja max. H=18 m
 Prurja max. Q=450 l/min

MHF22001

E RE

 Çmimi
18.500
Pompe vaditje 3"

 Fuqia 2200 W / 3 Hp
 Hedhja max. H=15 m
 Prurja max. Q=800 l/min

VPA37018

 Çmimi
6.900
Pompe vakumi me depozite

 Fuqia 370 W
 Hedhja max. H=28 m
 Prurja max. Q=30 l/min

VPS3708

 Çmimi
6.500
Pompe vakumi

 Fuqia 370 W
 Hedhja max. H=35 m
 Prurja max. Q=32 l/min

VPZ3708

 Çmimi
7.500
Pompe vakumi

 Fuqia 370 W
 Hedhja max. H=35 m
 Prurja max. Q=32 l/min

JPS075082

 Çmimi
9.900
Pompe presioni inoxi

 Fuqia 750 W
 Hedhja max. H=40 m
 Prurja max. Q=55 l/min

JPT07508

 Çmimi
16.900
Pompe presioni automatike

 Fuqia 750 W
 Hedhja max. H=45 m
 Prurja max. Q=60 l/min

SPC4008

E RE

 Çmimi
5.500
Pompe zhytесе / ujra te paster

 Fuqia 400 W
 Hedhja max. H= 8 m
 Prurja max. Q=117 l/min

SPD7501

 Çmimi
8.900
Pompe zhytесе / ujra te ndotur

 Fuqia 750 W
 Hedhja max. H=8 m
 Prurja max. Q=13.000 l/h

SPD7508

 Çmimi
6.900
Pompe zhytесе / ujra te ndotur

 Fuqia 750 W
 Hedhja max. H=8 m
 Prurja max. Q=210 l/min

SPD10001

 Çmimi
9.900
Pompe zhytесе / ujra te ndotur

 Fuqia 1000 W
 Hedhja max. H=9 m
 Prurja max. Q=333 l/min

SPDB15008

 Çmimi
19.900
INOKS
Pompe zhytесе / ujra te ndotur

 Fuqia 1500 W
 Hedhja max. H=14.5 m
 Prurja max. Q=20 m³/h

SPDB22008	SPDS7508	SPDS11008
 <p>Çmimi 28.900</p>	 <p>Çmimi 14.900</p>	 <p>Çmimi 15.900</p>
Pompe zhytесе Inoksi/ ujra pista	Pompe zhytесе / ujra te ndotur	Pompe zhytесе / ujra te ndotur
Fuqia 2200 W Hedhja max. H=13 m Prurja max. Q=635 l/min	Fuqia 750 W Hedhja max. H=13 m Prurja max. Q=18 m ³ /h	Fuqia 1100 W Hedhja max. H=15 m Prurja max. Q=22 m ³ /h
SPC3708	SPC5508	SPC7508
 <p>Çmimi 8.900</p>	 <p>Çmimi 9.900</p>	 <p>Çmimi 11.500</p>
Pompe zhytесе / ujra te paster	Pompe zhytесе / ujra te paster	Pompe zhytесе / ujra te paster
Fuqia 370 W Hedhja max. H=17 m Prurja max. Q=1500 l/min	Fuqia 550 W Hedhja max. H=25 m Prurja max. Q=6.5 m ³ /h	Fuqia 750 W Hedhja max. H=32 m Prurja max. Q=120 l/min
DWP3701	DWP5501	DWP7501
 <p>Çmimi 14.500</p>	 <p>Çmimi 16.900</p>	 <p>Çmimi 18.500</p>
Pompe pusi 4”	Pompe pusi 4”	Pompe pusi 4 “
Fuqia 370 W Hedhja max. H=48 m Nr. helikave 6	Fuqia 550 W Hedhja max. H=64 m Nr. helikave 8	Fuqia 750 W Hedhja max. H=80 m Nr. helikave 10
DWP3701-SB	DWP5501-SB	DWP7501-SB
 <p>Çmimi 1.790</p>	 <p>Çmimi 1.890</p>	 <p>Çmimi 1.990</p>
Kuader elektrik	Kuader elektrik	Kuader elektrik
Fuqia 370 W	Fuqia 550 W	Fuqia 750 kW

DWP11001

 Çmimi
19.900
Pompe pusi 4"

 Fuqia 1100 W
 Hedhja max. H=112 m
 Nr. helikave 14

DWP11001-SB

 Çmimi
1.990
Kuader elektrik

Fuqia 1100 W

SWP3701

 Çmimi
9.900
Pompe pusi 3"

 Fuqia 370 W
 Hedhja max. H=72 m
 Prurja max. Q=25 l/min

WAPS002

 Çmimi
2.650
Presostat pompe automatik

 Me manometer
 Presioni. 10 bar
 Diametri 1" x 1"

DWP15001

 Çmimi
24.900
Pompe pusi 4"

 Fuqia 1500 W
 Hedhja max. H=135 m
 Nr. helikave 17

DWP15001-SB

 Çmimi
2.190
Kuader elektrik

Fuqia 1500 W

SWP7501

 Çmimi
11.900
Pompe pusi 3"

 Fuqia 750 W
 Hedhja max. H=103 m
 Prurja max. Q=33 l/min

WPC1A01

 Çmimi
2.500
Presostat uji automatik

 Voltazhi 10A
 Presioni. 10 bar
 Diametri 1" x 1"

DWP22001

 Çmimi
27.500
Pompe pusi 4"

 Fuqia 2200 W
 Hedhja max. H=180 m
 Nr. helikave 23

DWP22001-SB

 Çmimi
2.490
Kuader elektrik

Fuqia 2200 W

WAPS001

 Çmimi
2.650
Presostat pompe automatik

 Voltazhi 220 - 240V
 Presioni. 10 bar
 Diametri 1" x 1"

WWPQDC12

 Çmimi
3.500

Pompe zhytесе / ujra te paster

 Fuqia 1700 W / 0.2 Hp
 Hedhja max 10 m
 Prurja max 50 Lt/min

 1
2
3
4
5
6
7
8
9
10

POMPE UJI VOLUMETRIKE

E RE

370W(0.5HP)

3.900

WWPVA01



Fuqia 370W
Hedhja max 30m
Prurja max 30Lt/min

POMPE UJI CENTRIFUGALE

E RE

750W(1HP)

7.900

WWPCA03



Fuqia 750W/1.0 Hp
Hedhja max 28m
Prurja max 100Lt/min

POMPE UJI PRESIONI

E RE

750W(1HP)

8.900

WWPJA03



Fuqia 750W/1.0Hp
Hedhja max 45m
Prurja max 50Lt/min

POMPE ZHYTESE PER UJRA TE PASTER

E RE

400W(0.5HP)

4.500

WWPFQ01



Fuqia 400W/0.5 Hp
Hedhja max 8m
Prurja max 134Lt/min

POMPE ZHYTESE PER UJRA TE NDOTUR

E RE

750W(1.0HP)

5.500

WWPFW03



Fuqia 750W/1.0 Hp
Hedhja max 8m
Prurja max 217Lt/min

POMPE ZHYTESE PER UJRA TE PASTER

E RE

750W(1HP)

9.500

WWPQA03



Fuqia 750W/1.0 Hp
Hedhja max 30m
Prurja max 110Lt/min

POMPE VOLUMETRIKE ME PANEL DIELLOR

E RE

400W(0.5HP)

12.900

WWPVDC01

(Nuk perfshihet paneli diellor)

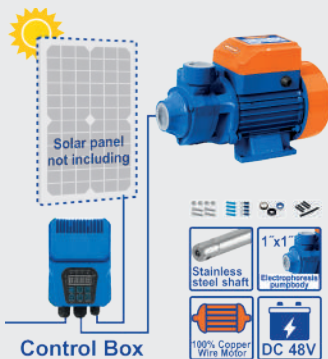

Fuqia 400W / 0.5Hp
Hedhja max 45m
Prurja max 41Lt/min

POMPE CENTRIFUGALE ME PANEL DIELLOR

E RE

550W(0.75HP)

16.900

WWPCDC02

(Nuk perfshihet paneli diellor)



Fuqia 550W/0.75Hp
Hedhja max 32m
Prurja max 91Lt/min

POMPE UJI CENTRIFUGALE ME PANEL DIELLOR

E RE

1500W(2.0HP)

29.900

WWPCDC051

(Nuk perfshihet paneli diellor)

Fuqia 1500W/2.0Hp
Hedhja max 26m
Prurja max 716Lt/min

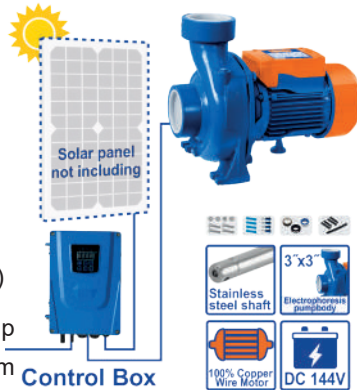

POMPE ZHYTESE ME PANEL DIELLOR PER UJRA TE PASTER

E RE

550W(0.75HP)

16.900

WWPQDC02

(Nuk perfshihet paneli diellor)

Fuqia 550W/0.75Hp
Hedhja max 25m
Prurja max 100Lt/min

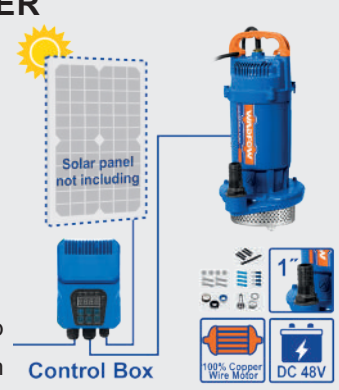

POMPE ZHYTESE ME PANEL DIELLOR PER UJRA TE PASTER

E RE

750W(1.0HP)

18.900

WWPQDC03

(Nuk perfshihet paneli diellor)

Fuqia 750W/1.0Hp
Hedhja max 25m
Prurja max 233Lt/min



POMPE ZHYTESE ME PANEL DIELLOR PER UJRA TE PASTER

E RE

1100W(1.5HP)

22.900

WWPQDC04

(Nuk perfshihet paneli diellor)

Fuqia 1100W/1.5Hp
Hedhja max 36m
Prurja max 266Lt/min



POMPE PUSI ME PANEL DIELLOR 4''

E RE

400W(0.5HP)

18.900

WWPDDC01

(Nuk perfshihet paneli diellor)

Fuqia 400W/0.5Hp
Hedhja max 36m
Prurja max 5m³/h me 3 helikal



POMPE PUSI ME PANEL DIELLOR 4''

E RE

750W(1.0HP)

22.900

WWPDDC03

(Nuk perfshihet paneli diellor)

Fuqia 750W/1.0Hp
Hedhja max 63m
Prurja max 6.5m³/h me 5 helika

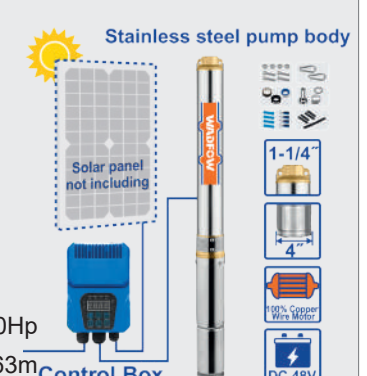

POMPE PUSI ME PANEL DIELLOR 4'

E RE

1100W(1.5HP)

22.900

WWPDDC04

(Nuk perfshihet paneli diellor)

Fuqia 1100W/1.5Hp
Hedhja max 87m
Prurja max 6.5m³/h me 7 helika



POMPE PUSI ME PANEL DIELLOR 4''

E RE

1500W(2.0HP)

29.900

WWPDDC05

(Nuk perfshihet paneli diellor)

Fuqia 1500W/2.0Hp
Hedhja max 111m
Prurja max 6.5m³/h me 9 helika

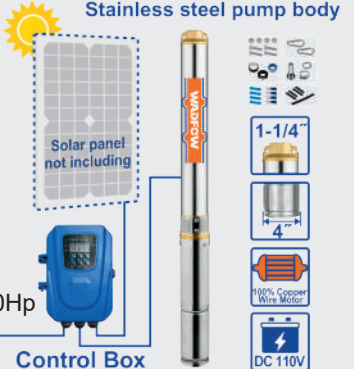



**MOTOPOMPE
ME BENZINE**

- | Fuqia 2.5 HP
- | Prurja 100 l/min
- | Dalja 1"
- | Lartesia 16 m

Kodi GWP102

CMIMI
14.900 Lek



1"



**MOTOPOMPE
ME BENZINE**

- | Fuqia 2.5 HP
- | Prurja 167 l/min
- | Dalja 1.5"
- | Lartesia 18 m

Kodi GWP152

CMIMI
15.900 Lek



1.5"



**MOTOPOMPE
ME BENZINE**

- | Fuqia 7.0 HP
- | Prurja 550 l/min
- | Dalja 2"
- | Lartesia 28 m

Kodi GWP202

CMIMI
19.900 Lek



2"



**MOTOPOMPE
ME BENZINE**

- | Fuqia 7.0 HP
- | Prurja 1000 l/min
- | Dalja 3"
- | Lartesia 32 m

Kodi GWP302

CMIMI
23.900 Lek



3"



**MOTOPOMPE
ME BENZINE**

- | Fuqia 9.0 HP
- | Prurja 1500 l/min
- | Dalja 4"
- | Lartesia 30 m

Kodi GWP402

CMIMI
25.900 Lek



4"



**MOTOPOMPE
ME NAFTE**

- | Fuqia 3.8 HP
- | Prurja 533 l/min
- | Dalja 2"
- | Lartesia 30 m

Kodi GEP201

CMIMI
29.900 Lek



2"

1
2
3
4
5
6
7
8
9
10

INGCO

**MOTOPOMPE
ME NAFTE**

- | Fuqia 5.5 HP
- | Prurja 1000 l/min
- | Dalja 3"
- | Lartesia 28 m

Kodi GEP301

**CMIMI
34.500 Lek**



INGCO

**MOTOPOMPE
ME NAFTE**

- | Fuqia 8.3 HP
- | Prurja 1420 l/min
- | Dalja 4"
- | Lartesia 25 m

Kodi GEP401

**CMIMI
49.900 Lek**



LAUNTOP

**MOTOPOMPE
ME BENZINE**

- | Fuqia 7 HP/208cc
- | Prurja 30 m³ / h
- | Dalja 2"
- | Lartesia 25 m
- | Thithja max 8 m

Kodi LTP50C

**CMIMI
18.900 Lek**



LAUNTOP

**MOTOPOMPE
ME BENZINE**

- | Fuqia 7 HP/208cc
- | Prurja 25 m³ / h
- | Dalja 3"
- | Lartesia 25 m
- | Thithja max 8 m

Kodi LTP80C

**CMIMI
19.900 Lek**



LAUNTOP

**MOTOPOMPE
ME BENZINE**

- | Fuqia 7 HP/208cc
- | Prurja 28 m³ / h
- | Dalja 2"
- | Lartesia 35 m

Kodi LTF50C

**CMIMI
29.900 Lek**



LAUNTOP

**MOTOPOMPE PRESIONI
ME BENZINE**

- | Fuqia 16 HP/420cc
- | Prurja 40 m³ / h
- | Dalja 3"
- | Lartesia 65 m

Kodi LTF80C

**CMIMI
39.900 Lek**



LAUNTOP

**MOTOPOMPE
ME BENZINE IRON**

- | Fuqia 9.0 HP/270cc
- | Prurja 25 m³ / h
- | Dalja 2"
- | Lartesia 55 m



Kodi LTTP50DC

**CMIMI
29.900 Lek**

LAUNTOP

**MOTOPOMPE PRESIONI
ME NAFTE IRON**

- | Fuqia 10 HP/418cc
- | Prurja 50 m³ / h
- | Dalja 3"
- | Lartesia 65 m



Kodi LTTP80DC

**CMIMI
34.500 Lek**

LAUNTOP

**MOTOPOMPE
ME NAFTE KERMILL**

- | Fuqia 16 HP/460cc
- | Prurja 25 m³ / h
- | Dalja 2"
- | Lartesia 55 m



Kodi LDTP50DC

**CMIMI
52.500 Lek**

LAUNTOP

**MOTOPOMPE
ME NAFTE KERMILL**

- | Fuqia 16 HP/460cc
- | Prurja 50 m³ / h
- | Dalja 3"
- | Lartesia 65 m



Kodi LDTP80C

**CMIMI
55.900 Lek**

LAUNTOP

**MOTOPOMPE
ME NAFTE**

- | Fuqia 4.2 HP/211cc
- | Prurja 30 m³ / h
- | Dalja 2"
- | Lartesia 25 m



Kodi LDP50C

**CMIMI
39.500 Lek**

LAUNTOP

**MOTOPOMPE
ME NAFTE**

- | Fuqia 5.4 HP/296cc
- | Prurja 50 m³ / h
- | Dalja 3"
- | Lartesia 25 m



Kodi LDP80C

**CMIMI
49.000 Lek**

LAUNTOP

MOTOPOMPE ME NAFTE

- | Fuqia 10 HP/418cc
- | Prurja 90 m³ / h
- | Dalja 4"
- | Lartesia 25 m

Kodi LDP100CE

**CMIMI
59.900 Lek**



LAUNTOP

MOTOPOMPE PRESIONI ME NAFTE

- | Fuqia 6.7 HP/296cc
- | Prurja 20 m³ / h
- | Dalja 2"
- | Lartesia 55 m

Kodi LDF50C

**CMIMI
37.900 Lek**



LAUNTOP

MOTOPOMPE PRESIONI ME NAFTE

- | Fuqia 10 HP/418cc
- | Prurja 40 m³ / h
- | Dalja 3"
- | Lartesia 60 m

Kodi LDF80C

**CMIMI
49.500 Lek**



**FORCE
MACHINERY - TOOLS**

MOTOPOMPE ME BENZINE ME 2 KOHE

- | Fuqia 1.25 kW
- | Prurja 135 l/min
- | Dalja 1"
- | Lartesia 30 m

Kodi WP10G

**CMIMI
13.500 Lek**



**FORCE
MACHINERY - TOOLS**

MOTOPOMPE ME BENZINE ME 2 KOHE

- | Fuqia 1.25 kW
- | Prurja 250 l/min
- | Dalja 1.5"
- | Lartesia 35 m

Kodi WP15G

**CMIMI
14.900 Lek**



**FORCE
MACHINERY - TOOLS**

MOTOPOMPE ME BENZINE

- | Fuqia 6.5 HP / 196cc
- | Prurja 36.000 l/ore
- | Dalja 3"
- | Lartesia 23 m

Kodi WX-WP20

**CMIMI
12.200 Lek**



FORCE
MACHINERY - TOOLS

MOTOPOMPE ME BENZINE

- | Fuqja 6.5 HP / 196cc
- | Prurja 60.000 l/ore
- | Dalja 3"
- | Lartesia 28 m



Kodi WX-WP30

CMIMI
13.500 Lek

FORCE
MACHINERY - TOOLS

MOTOPOMPE ME BENZINE

- | Fuqja 9.5 HP / 389cc
- | Prurja 1330 l/min
- | Dalja 4"
- | Lartesia 28 m



Kodi WX-WP40

CMIMI
28.500 Lek

FORCE
MACHINERY - TOOLS

MOTOPOMPE PRESIONI ME BENZINE

- | Fuqja 6.5 HP
- | Prurja 42.000 l/ore
- | Dalja 2"
- | Lartesia 65 m



Kodi WX-WP20H

CMIMI
14.900 Lek



FORCE
MACHINERY - TOOLS

MOTOPOMPE PRESIONI ME BENZINE

- | Fuqja 10 HP
- | Prurja 40 m³ / h
- | Dalja 3"
- | Lartesia 60 m



Kodi WX-WP30H

CMIMI
19.900 Lek

LAUNTOP

MOTOR ME BENZINE

- | Fuqja 208 cc
- | Fuqja 7.0 HP
- | Depozita 3.6 lt
- | Ftohje me ajer
- | Boshti i motorit 19 mm me kiavete



Kodi LT210

CMIMI
14.500 Lek

LAUNTOP

MOTOR ME BENZINE

- | Fuqja 270 cc
- | Fuqja 9.0 HP
- | Depozita 6 lt
- | Ftohje me ajer
- | Boshti i motorit 25.4 mm me kiavete



Kodi LT270

CMIMI
19.900 Lek

LAUNTOP

MOTOR ME BENZINE

- | Fuqia 420 cc
- | Fuqia 16 HP
- | Depozita 6 lt
- | Ftohje me ajer
- Boshti i motorit 25.4 mm me kiavete

Kodi LT420

CMIMI
29.500 Lek



FORCE
MACHINERY - TOOLS

MOTOR BENZINE ME KIAVETE

- | Fuqia 196 cc
- | Fuqia 6.5 HP
- | Depozita 3.6 lt
- | Ftohje me ajer
- Boshti i motorit konik/19 mm me kiavete

Kodi WX-168F

CMIMI
9.900 Lek



LAUNTOP

MOTOR NAFTE

- | Fuqia 211 cc
- | Fuqia 4.7 HP
- | Depozita 4.5 lt
- | Ftohje me ajer
- Boshti motorit 19 mm me kiavete

Kodi LA170F

CMIMI
29.900 Lek



LAUNTOP

MOTOR NAFTE

- | Fuqia 296 cc
- | Fuqia 6.7 HP
- | Depozita 3.5 lt
- | Ftohje me ajer
- Boshti i motorit 25.4 mm me kiavete

Kodi LA178F

CMIMI
35.900 Lek



LAUNTOP

MOTOR NAFTE ME MOTORRINO

- | Fuqia 418 cc
- | Fuqia 10 HP
- | Depozita 5.5 lt
- | Ftohje me ajer
- Boshti i motorit 25.4 mm me kiavete

Kodi LA186FE

CMIMI
45.900 Lek



INGCO
Professional Tools Made Affordable

MOTOR ME BENZINE MOTOR 4 KOHESH

- | Fuqia 196 cc
- | Fuqia 13 HP
- | Ftohje me ajer
- Boshti i motorit 25.4 mm me kiavete

Kodi GEN1882

CMIMI
17.500 Lek





MOTOR BENZINE

- | Motori 105cc, 2.5HP
- | Shpejtësia e rrot. 1800 rpm
- | Kapja me kjavete
- | Depozita e karburantit 1.2L
- | Depozita e vajit 0.4L

Kodi GWP102-SP-1

CMIMI
11.500 Lek



MOTOR BENZINE

- | Motori 208cc OHV, 7.0HP
- | Kapja 19mm
- | Shpejtësia e rrotullimit 1800 rpm
- | Depozita e karburantit 3.6L
- | Depozita e vajit 0.6L

Kodi GWP302-SP-1

CMIMI
12.500 Lek



MOTOR BENZINE PER KORRESE

- | Motori 141cc
- | Fuqia 3 0Kw, 4HP
- | Shpejtësia e rrot. 2600rpm
- | Depozita e karburantit 0.9L
- | Depozita e vajit 0.5L

Kodi GLM141181-SP-B25

CMIMI
14.500 Lek



MOTOR NAFTE

- | Motori 211cc, 3.8HP
- | Shpejtësia e rrot. 3600 rpm
- | Kapja me kjavete
- | Ftohje me ajer
- | Depozita e karburantit 12.5 L

Kodi GEP201-SP-50

CMIMI
27.500 Lek



MOTOR NAFTE

- | Motori 296cc, 5.5HP
- | Shpejtësia e rrot. 3600 rpm
- | Kapja 19mm me kjavete
- | Ftohje me ajer
- | Depozita e karburantit 12.5 L

Kodi GEP301-SP-59

CMIMI
29.500 Lek



MOTOR NAFTE

- | Motori 418cc, 8.3HP
- | Shpejtësia e rrot. 3600 rpm
- | Kapja me kjavete
- | Ftohje me ajer
- | Depozita e karburantit 12.5 L

Kodi GEP401-SP-59

CMIMI
39.500 Lek



**GJENERATOR INVERTER
ME BENZINE**



IRI

Motori me 4 kohe OHV
Fuqia max ne dalje
1.2 kW

Kodi GEI15006

CMIMI
38.900 Lek



**GJENERATOR SILENCIOZ
ME BENZINE INVERTER**



Motori me 4 kohe OHV
Fuqia max ne dalje
2.2 kW

Kodi GEI30001

CMIMI
55.500 Lek



**GJENERATOR SILENCIOZ
ME BENZINE INVERTER**



IRI

Motori me 4 kohe OHV
Fuqia max ne dalje
3.2 kW
Ndezje me litar

Kodi GEI35006

CMIMI
64.500 Lek



**GJENERATOR INVERTER
ME BENZINE**



IRI

Motori me 4 kohe OHV
Fuqia max ne dalje
4.0 kW

Kodi GEI47506E

CMIMI
87.500 Lek



**GJENERATOR TIGER ME
BENZINE**



Motori me 2 kohe
Fuqia max ne dalje 0.8 kW

Kodi GE8002

CMIMI
14.500 Lek



**GJENERATOR ME
BENZINE**



IRI

Motori me 4 kohe OHV
Fuqia max ne dalje 1.2 kW

Kodi GE15005

CMIMI
24.900 Lek





GJENERATOR ME BENZINE

- | Motori me 4 kohe OHV
- | Fuqia max ne dalje 1.2 kW

Kodi GE150026

CMIMI
26.900 Lek



GJENERATOR ME BENZINE

- | Motori me 4 kohe OHV
- | Fuqia max ne dalje 2.8 kW

Kodi GE30005

CMIMI
28.900 Lek



GJENERATOR ME BENZINE

- | Motori me 4 kohe OHV
- | Fuqia max 3.5 kW

Kodi GE35006

CMIMI
39.900 Lek



GJENERATOR ME BENZINE

- | Motori me 4 kohe OHV
- | Fuqia max 3.5 kW
- Ndezje elektrike opsionale

Kodi GE35006ES

CMIMI
48.500 Lek



GJENERATOR ME BENZINE

- | Motori me 4 kohe OHV
- | Fuqia max ne dalje 5.5 kW
- | Ndezje elektrike opsionale

Kodi GE55003

CMIMI
55.900 Lek



DALJE DC/12V



GJENERATOR ME BENZINE

- | Motori me 4 kohe OHV
- | Fuqia max ne dalje 6.5 kW
- | Ndezje elektrike opsionale

Kodi GE65006

CMIMI
69.900 Lek



GJENERATOR ME BENZINE

- Motori me 4 kohe OHV
- Fuqia max ne dalje 9.0 kW
- Ndezje elektrike

Kodi GE90006

CMIMI
75.900 Lek



INGCO
Professional Tools Made Affordable

IRI

GJENERATOR ME NAFTE

- Motori 5.7 HP
- Fuqia max ne dalje 3.0 kW

Kodi GDE30001

CMIMI
69.900 Lek



INGCO
Professional Tools Made Affordable

DALJE DC/12V

GJENERATOR ME NAFTE

- Motori me 4 kohe OHV
- Fuqia max ne dalje 5.0 kW
- Ndezje elektrike opsionale

Kodi GDE50001

CMIMI
99.500 Lek



INGCO
Professional Tools Made Affordable

DALJE DC/12V

GJENERATOR ME NAFTE TREFAZOR

- Motori 9.0 HP
- Fuqia max ne dalje 5.0 kW
- Ndezje elektrike

Kodi GDE50003

CMIMI
95.900 Lek



INGCO
Professional Tools Made Affordable

IRI

RREGULLATOR TENSIONI

- Tensioni 5 kVA
- Pesha 25 kg

Kodi VS503

CMIMI
28.900 Lek



INGCO
Professional Tools Made Affordable

RREGULLATOR TENSIONI

- Tensioni 10 kVA
- Pesha 35 kg

Kodi VS1003

CMIMI
48.900 Lek



INGCO
Professional Tools Made Affordable

GJENERATOR SILENCIOZ ME NAFTE

- | Motori 13.0 HP / 3 FAZOR
- | Fuqia max ne dalje 8.0 kW
- | Ndezje elektrike
- | Numri i xhirove 3000 rpm
- | Depozita 25 Lt
- | Pesha 236 kg

Kodi GSE80003

CMIMI
199.500 Lek

IRI



8kW

Three phase



Low Noise



Diesel



Electric Start



GJENERATOR SILENCIOZ ME NAFTE

- | Motori 12.0 HP
- | Fuqia max ne dalje 6.5 kW
- | Ndezje elektrike
- | Numri i xhirove 3000 rpm
- | Depozita 17 Lt
- | Pesha 173 kg

Kodi GSE65001

CMIMI
139.500 Lek



6.5kW

Single phase



Low Noise



Diesel



Electric Start



GJENERATOR SILENCIOZ ME NAFTE

- | Motori 9.0 HP / 3 FAZOR
- | Fuqia max ne dalje 5.0 kW
- | Ndezje elektrike
- | Numri i xhirove 3000 rpm
- | Depozita 15 Lt
- | Pesha 172 kg

Kodi GSE50003

CMIMI
116.500 Lek

IRI



5kW

Three phase



Low Noise



Diesel



LAUNTOP

GJENERATOR SILENCIOZ ME NAFTE

- | Motori LA188F
- | Fuqia max ne dalje 5.0 / 5.3 kW
- | Ndezje elektrike opsionale

Kodi LDG6500SA

CMIMI
139.000 Lek



LAUNTOP

GJENERATOR ME NAFTE

- | Motori LA186FA
- | Fuqia max ne dalje 4.5 / 5.0 kW
- | Ndezje elektrike opsionale

Kodi LDG6000CLE

CMIMI
99.900 Lek



LAUNTOP

GJENERATOR ME NAFTE

- | Motori LA170F
- | Fuqia max ne dalje 1.7 / 2.0 kW
- | Ndezje elektrike opsionale

Kodi LDG2200CLE

CMIMI
79.900 Lek



LAUNTOP

GJENERATOR ME BENZINE

- | Motori 208 cc
- | Fuqia 2.5 / 2.58 kW

Kodi LT3500CLE

CMIMI
42.500 Lek



LAUNTOP

GJENERATOR ME BENZINE PORTABEL

- | Motori me 2 kohe
- | Madhesia motorit 87 cc
- | Fuqia max 0.9 / 1.0 kW

Kodi LT1200CL

CMIMI
19.900 Lek



LAUNTOP

GJENERATOR PORTABEL ME BENZINE

- | Motori me 2 kohe
- | Madhesia motorit 63 cc
- | Fuqia max 0.72 kW

Kodi LT950DC

CMIMI
13.900 Lek



SHKUNDESE ULLIRI

Proces super i thjeshte fale baterise apo motorit i cili ben te mundur levizjen e shpejte te kokes dhe rrjedhimisht shkundjen e plote te degeve.

Vjelja me rrjete e ullirit eshte me e mira qe mund te besh pasi parandalon humbjen e kokrave dhe ndotjen e tyre.



MINOS NIK
ANO TO 1993

SHKUNDESE ULLIRI GOLD CARBON

- Me koke karboni
- Gjatesia: 2.4m tub
- Rendimenti: 200 kg/ore
- Kabulli: 15 metra 2 X 3 MM
- 1.4 m tub
- Voltazhi: 12 V / 24 V

Kodi 920001

CMIMI
39.900 Lek

CARBON HEAD

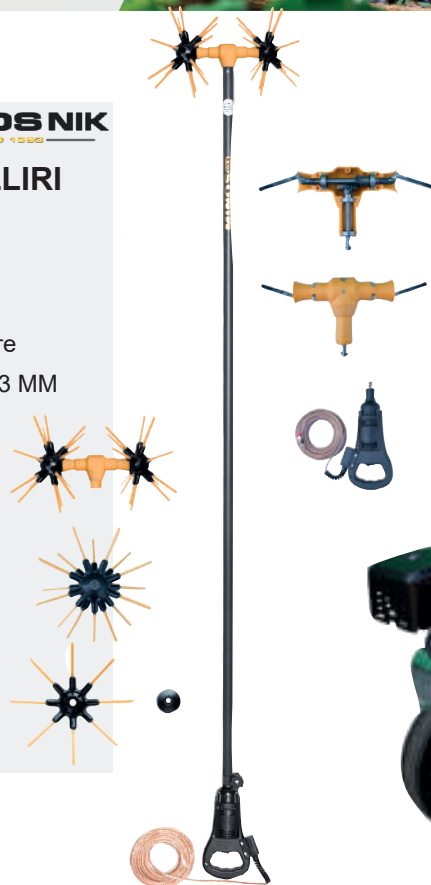

LONCIN

GJENERATOR DINAMO LONCIN

- Fuqia max AC: 1.5 KVa
- Fuqia max DC: 12 V / 60 A
- Fuqia e motorit: 6.5 Hp
- Motor me 4 kohe 196 cm3
- Depozita 3.6 Lt

Kodi 920000

CMIMI
49.900 Lek



Rrjete per ullinj

Modeli	Permasa	Çmimi
SN7050	90gr 6x12m	5.990
SN7100	90gr 7x12m	6.900
SN7150	90gr 7x14m	8.500
SN7200	90gr 8x12m	8.500
SN7250	90gr 8x14m	8.900

920009



Çmimi
14.900

Bateri makine per shkundes ulliri

12 V / 80 Ah



- 1
- 2
- 3
- 4
- 5
- 6
- 7
- 8
- 9
- 10

SHKUNDESE ULLIRI ME BATERI GE-FS

- | Gjeresi punimi 53 cm
- | Koke karboni / Trup alumini
- | Gjatesia max 310 cm
- | Vetem trup

Kodi 34.114.00

CMIMI
21.500 Lek



STARTER KIT

Set me bateri
18 V / 4.0 + karikues



Art. 45.120.42
CMIMI 7.500 Lek



P20S

SHKUNDESE ULLIRI ME BATERI









- | Fuqja 2x40V/4.0Ah
- | Motor pa karboncina
- | Gjeresi punimi 38 cm

Kodi COHLI200386

CMIMI
34.900 Lek

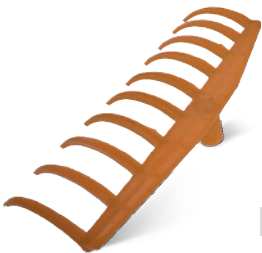

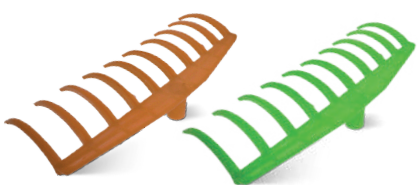
Removable

03.01	03.05	03.09
 <p style="text-align: right;">Çmimi 120</p>	 <p style="text-align: right;">Çmimi 130</p>	 <p style="text-align: right;">Çmimi 190</p>
KREHER PER VJELJE I DREJTE PLASTIK 102	KREHER PER VJELJE I HARKUAR PLASTIK 103	KREHER PER VJELJE I HARKUAR PLASTIK 104
Nr i dhembeve 10	Nr i dhembeve 11	Nr i dhembeve 9
Gjeresia 30 cm	Gjeresia 30 cm	Gjeresia 30 cm
03.13	03.21	03.18
 <p style="text-align: right;">Çmimi 190</p>	 <p style="text-align: right;">Çmimi 450</p>	 <p style="text-align: right;">Çmimi 210</p>
KREHER PER VJELJE I HARKUAR PLASTIK 105	KREHER PER VJELJE I HARKUAR PLASTIK 106	KREHER PER VJELJE I HARKUAR
Nr i dhembeve 9	Nr i dhembeve 13	Nr i dhembeve 9
Gjeresia 30 cm		
03.32	04.17	04.16
 <p style="text-align: right;">Çmimi 750</p>	 <p style="text-align: right;">Çmimi 1.290</p>	 <p style="text-align: right;">Çmimi 1.490</p>
KREHER PER VJELJE I HARKUAR PLASTIK 111	KREHER MBLEDHES METALIK ME KOKE TE RREGULLUESHME 700 A	KREHER MBLEDHES METALIK ME KOKE TE RREGULLUESHME 7004
Nr i dhembeve 10	Nr i dhembeve 22	Nr i dhembeve 22

BLUARSE DRITHRASH

! Përdoret për të bluar një shumëllojshmëri të gjerë të drithërave, fasuleve dhe orizit.

! Është projektuar që të jetë i lehtë për t'u përdorur dhe pastruar, dhe motori i tij ofron fuqi të fuqishme bluarjeje.

! Bluarsi i drithrave është gjithashtu shumë i aftë të ruajë shijen e ushqimit që bluan fale mekanizmit special te bluarjes. Së fundi, aftësia e tij për të bluar një shumëllojshmëri të gjerë ushqimesh e bën atë një zgjedhje të shkëlqyer për ata që kërkojnë shkathtësi në kuzhinën e tyre.



BLUARSE DRITHRASH

- ! Fuqia 1.5 Hp
- ! Prodhimi 240 kg/h
- ! Me 4 slita: 2, 5, 5, 6 mm

Kodi FM1100

CMIMI
16.900 Lek

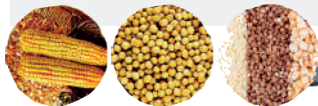

NAKAYAMA
PRO



BLUARSE MISRI

- ! Fuqia 2200 W
- ! Produktiviteti 68 kg/h
- ! Nr rrotullimeve 1500 rpm

Kodi 6NF-140

CMIMI
9.900 Lek

FORCE
MACHINERY - TOOLS



BLUARSE DRITHRASH

- ! Fuqia 1.1 KW (1.5 Hp)
- ! Produktiviteti 240 kg/h
- ! Nr rrotullimeve 2900 r/min

Kodi CM-1.1B

CMIMI
7.900 Lek



FORCE
MACHINERY - TOOLS



BLUARSE DRITHRASH

- ! Fuqia 2.2 KW (3.0 Hp)
- ! Produktiviteti 600 kg/h
- ! Nr rrotullimeve 2900 r/min

Kodi CM-2.0D

CMIMI
26.900 Lek



FORCE
MACHINERY - TOOLS



SHKERMOQESE PER KALLI MISRI

- Fuqia 0.55 kW
- Produktiviteti 180 kg/h
- Nr rrotullimeve 2900 r/min

Kodi 5STY-40-90

CMIMI
9.900 Lek



FORCE
MACHINERY - TOOLS



SHKERMOQESE PER KALLI MISRI

- Fuqia 0.75 kW (1.0 Hp)
- Produktiviteti 240 kg/h
- Nr rrotullimeve 2900 r/min

Kodi 5STY-50-90

CMIMI
12.500 Lek



FORCE
MACHINERY - TOOLS



SHTRYDHESE RRUSHI MEKANIKE

- Produktiviteti 180 kg/h
- E emaluar per mbrojtje nga faktoret atmosferik dhe ato kimik

Kodi HGP-50
CMIMI
4.500 Lek



FORCE
MACHINERY - TOOLS

SHTRYDHESE RRUSHI ELEKTRIKE

- Fuqia 0.55 kW (0.75 Hp)
- Produktiviteti 280 kg/h
- Nr rrotullimeve 2900 r/min

Kodi HGP-60
CMIMI
9.900 Lek



FORCE
MACHINERY - TOOLS

ELEKTRIKE

FORCE
MACHINERY - TOOLS



FORCE
MACHINERY - TOOLS



Thike komplet per bluarsen CM-1.1B

Kodi	Per bluarsen	Cmimi
THK1.1B	CM-1.1B	1.350

FORCE
MACHINERY - TOOLS



Kapak rezerve per bluarsen

Kodi	Permasa	Cmimi
KBL1	Per CM-1.1B	3.590

Site per bluarsen CM-1.1B

Kodi	Permasa	Cmimi
ST1	1"	230
ST2	2"	260
ST3	3"	310
ST4	4"	340
ST5	5"	430

FORCE
MACHINERY - TOOLS



Cilinder i brendshem HGP50/HGP60

Kodi	Permasa	Cmimi
INB-50/60	1"	2.500

FORCE
MACHINERY - TOOLS



Cilinder i jashtem per HGP50/HGP60

Kodi	Permasa	Cmimi
INO-50	HGP50	220
INO-60	HGP60	590



LAVAZHE DHE

FSHESA ME KORENT

Gamë e gjeneratës së zgjuar
Zgjerimi i performancës me

DUEL TECHNOLOGIES



ARXP



Lavazh ARXP SMART BOX5 DSS



- | Fuqia 2700W,
- | Presioni 160Bar,
- | Konsumi 850l/h,
- | Me aksesore dhe 3 koka



Kodi 15452

CMIMI
29.900 Lek



Lavazh ARXP SMART BOX4 DSS



- | Fuqia 2500W,
- | Presioni 180Bar,
- | Konsumi 500l/h,
- | Me aksesore



Kodi 15453

CMIMI
25.900 Lek



Lavazh ARXP SMART BOX3 LHT



- | Fuqia 1900W,
- | Presioni 150Bar,
- | Konsumi 460l/h,
- | Me aksesore



Kodi 15454

CMIMI
22.900 Lek



LAVAZH ME BATERI

- Te pajisura me një motor të fuqishëm që është në gjendje t'ju japë shumë fuqi pastrimi për të përballuar edhe punët më të vështira.
- Dizajni kompakt i tyre ju mundeson ruajtjen dhe transportin e lehtë, duke i bërë ato ideale si për përdorim shtëpiak ashtu edhe për profesional.
- Te pajisura me një sërë aksesorësh, të tillë si rezervuar sapuni dhe pistoletë spërkatëse të rregullueshme, të cilat i bëjnë ato të përshtatshëm për pastrimin e një sërë sipërfaqesh.



LAVAZH ME BATERI

- Me 1 bateri 20 V / 2.0 Ah
- Presioni 24.8 bar
- Prurja 2.2 l/min

Kodi CPWLI20082

CMIMI
9.900 Lek



LAVAZH PROFESIONAL

- Fuqia 7.5 hp
- Presioni 200 bar
- Konsumi 15 l/min
- Testate e nikeluar



MADE IN ITALY

Kodi MODEL2

CMIMI
99.500 Lek



LAVAZH PROFESIONAL

- Fuqia 7.5 hp
- Presioni 200 bar
- Konsumi 15 l/min
- Testate bronxi



MADE IN ITALY

Kodi MODEL5

CMIMI
89.500 Lek



LAVAZH MOD 630K I KOMPLETUAR

- | Fuqia 2600 W
- | Presioni 120 bar
- | Konsumi 600 l/h
- | Monofaze



Kodi 14633

CMIMI
79.500 Lek



LAVAZH MOD 630

- | Fuqia 2600 W
- | Presioni 120 bar
- | Konsumi 600 l/h
- | Monofaze



Kodi 12360

CMIMI
75.900 Lek



LAVAZH MOD 591

- | Fuqia 2.8 KW
- | Presioni 180 bar
- | Konsumi 600 l/h



Kodi 14990

CMIMI
59.900 Lek



LAVAZH MOD 5 TWIN ME 2 MOTORA

- | Fuqia 2.7 KW
- | Presioni 160 bar
- | Konsumi 850 l/h
- | Grupi Alumin



Kodi 14793

CMIMI
49.900 Lek



LAVAZH MOD 4 TWIN ME 2 MOTORA

- | Fuqia 2500 W
- | Presioni 150 bar
- | Konsumi 810 l/h
- | Grupi Alumin



Kodi 14792

CMIMI
35.900 Lek



LAVAZH IDROP 2NE1 DHE SPERKATES

- | Fuqia 2200 W
- | Presioni 160 bar
- | Konsumi 420 l/h



Kodi 15153

CMIMI
19.900 Lek



LAVAZH MOD 475

- Fuqia 2000 W
- Presioni 160 bar
- Konsumi 480 l/h



Kodi 14328

CMIMI
16.900 Lek



LAVAZH MOD 387

- Fuqia 1.9 kW
- Presioni 150 bar
- Konsumi 420 l/h



Kodi 15458

CMIMI
14.900 Lek



LAVAZH IDROP ARBC

- Fuqia 1400 W
- Presioni 120 bar
- Konsumi 390 l/h



Kodi 15147

CMIMI
9.900 Lek



LAVAZH MOD 117 TSS

- Fuqia 1300 W
- Presioni 100 bar
- Konsumi 390 l/h
- Grup Alumini



Kodi 13689

CMIMI
8.900 Lek



LAVAZH

- Fuqia 2000 W
- Presioni 150 bar
- Prurja 450 l/min



Kodi BPW2610

CMIMI
14.900 Lek



LAVAZH

- Fuqia 1600 W
- Presioni 135 bar
- Prurja 408 l/min



Kodi BPW2210

CMIMI
13.500 Lek



LAVAZH PROFESIONAL

- | Fuqia 2400 W
- | Presioni 100 bar
- | Prurja 10 l/min

Kodi HPWR30018

CMIMI
29.900 Lek



LAVAZH

- | Fuqia 2800 W
- | Presioni 180 bar
- | Prurja 7.3 l/min

Kodi HPWR28008

CMIMI
28.900 Lek



LAVAZH

- | Fuqia 2500 W
- | Presioni 160 bar
- | Prurja 6.0 l/min

Kodi HPWR25008

CMIMI
25.500 Lek



LAVAZH

- | Fuqia 2000 W
- | Presioni 150 bar
- | Prurja 6.0 l/min

Kodi HPWR20008

CMIMI
19.500 Lek



LAVAZH

- | Fuqia 1800 W
- | Presioni 150 bar
- | Prurja 6.0 l/min

Kodi HPWR18008

CMIMI
12.500 Lek



LAVAZH

- | Fuqia 1400 W
- | Presioni 130 bar
- | Prurja 5.5 l/min

Kodi HPWR14008

CMIMI
8.500 Lek



1

incco

LAVAZH

- | Fuqia 1200 W
- | Presioni 90 bar
- | Prurja 5.5 l/min

Kodi HPWR12008

CMIMI
7.500 Lek



WADFOV

LAVAZH

- | Fuqia 1400 W
- | Presioni 110 bar
- | Prurja 5.6 l/min

Kodi WHP3A14

CMIMI
6.900 Lek



2

3

4

**ANNOVI
REVERBERI**
The Power of Experience

GRUP LAVAZHI RK 15.20 H N

- | Grup me 3 pistona seria 322RR
- | Presioni 200 bar
- | Prurja max 15 l/min
- | Pershtatet me motore 7.5 Hp

MADE IN ITALY

Kodi 20638

CMIMI
39.900 Lek



**ANNOVI
REVERBERI**
The Power of Experience

GRUP LAVAZHI RR 15.20 N

- | Grup me 3 pistona seria
- | Presioni 200 bar
- | Prurja max 15 l/min
- | Pershtatet me motore 7.5 Hp

MADE IN ITALY

Kodi 23507

CMIMI
35.900 Lek



5

6

7

**ANNOVI
REVERBERI**
The Power of Experience

GRUP LAVAZHI HRK15.20N ME MOTOR

- | Grup me 3 pistona seria
- | Presioni 200 bar
- | Prurja max 15 l/min
- | Pershtatet me motore 7.5 Hp

MADE IN ITALY

Kodi 23021

CMIMI
87.900 Lek



**ANNOVI
REVERBERI**
The Power of Experience

GRUP LAVAZHI HRR 15.20N ME MOTOR

- | Grup me 3 pistona seria 322RR
- | Presioni 200 bar
- | Prurja max 15 l/min
- | Pershtatet me motore 7.5 Hp

MADE IN ITALY

Kodi 23979

CMIMI
79.500 Lek



8

9

10

ASPIRATOR ME 2 MOTORA 4300P

- Fuqia 2400 W
- Depozita 77 lt
- Thithja 22.1 kpa



Kodi 52509

CMIMI 49.900 Lek



ASPIRATOR INOXI 4700S

- Fuqia 1600 W
- Depozita 36 lt
- Thithja 23.5 kpa



Kodi 51065

CMIMI 39.900 Lek



ASPIRATOR MOD 3670

- Fuqia 1600 W
- Depozita 30 lt
- Thithja 19 kpa
- Thithje pluhur dhe uje

Kodi 51927

CMIMI 15.500 Lek



ASPIRATOR ME 3 MOTORA PROFESIONAL

- Fuqia 3000 W
- Depozita 80 lt inox
- Thithja 9700L/min
- Thithje pluhur dhe uje

Kodi BVC7510

CMIMI 39.000 Lek



ASPIRATOR INOXI

- Fuqia 1200 W
- Depozita 20 lt
- Me te njome dhe te thate
- Me aksesore

Kodi BVC2600

CMIMI 6.900 Lek



LAVAMOKET

- Fuqia 1400 W
- Depozita 20 lt

Kodi BVC4100

CMIMI 14.900 Lek



ASPIRATOR ME BATERI

- | Bateria: 20 V
- | Depozita 20 lt
- | Thithja 8 kpa
- | Thithje pluhur
- | Vetem trup

Kodi CVLI2005E

CMIMI
8.500 Lek



ASPIRATORE INOXI ME 2 MOTORA

- | Fuqia 2400 w
- | Depozita 75 lt
- | Thithja 16-17 kpa
- | Thithje pluhur dhe uje

Kodi VC24751

CMIMI
28.500 Lek



ASPIRATOR

- | Fuqia 1400 w
- | Depozita 30 lt
- | Thithja 16-18 kpa
- | Thithje pluhur dhe uje

Kodi VC14301

CMIMI
11.900 Lek



ASPIRATOR

- | Fuqia 1300 w
- | Depozita 30 lt
- | Thithja 16 kpa
- | Thithje pluhur dhe uje

Kodi VC13301

CMIMI
8.500 Lek



ASPIRATOR

- | Fuqia 800 w
- | Depozita 12 lt
- | Thithja 16 kpa
- | Thithje pluhur dhe uje

Kodi VC14122

CMIMI
6.900 Lek



ASPIRATOR ME 3 MOTORA

- | Fuqia 3600 W
- | Depozita 90 lt
- | Ne te thate dhe te lagesht

Kodi WVR5A90

CMIMI
24.900 Lek



ASPIRATOR ME 2 MOTORA

- | Fuqia 2400 W
- | Depozita 60 lt
- | Ne te thate dhe te lagesht



Kodi WVR5A60

CMIMI
17.900 Lek

ASPIRATOR

- | Fuqia 1200 W
- | Depozita 35 lt
- | Ne te thate dhe te lagesht



Kodi WVR4A35

CMIMI
6.900 Lek

PASTRUESE ME AVULL

- | Fuqia: 1200W
- | Presioni 4 bar
- | Me aksesore



Kodi BVC4300

CMIMI
24.900 Lek

ASPIRATOR HIRI

- | Fuqia max: 1200W
- | Me funksion fryres



Kodi BVC1000

CMIMI
3.990 Lek

ASPIRATOR HIRI

- | Fuqia max: 1200 W
- | Depozite Inoksi 18 Lt

DRY

Kodi 23.516.61

CMIMI
4.900 Lek



FILTER ASPIRATORI HIRI

Kodi 23.516.06

- | Depozita 12 L

CMIMI
3.900 Lek

Kodi 23.516.12

- | Depozita 18 L

CMIMI
2.500 Lek



CVLI20126

≥9kPa



Çmimi
5.500

Aspirator makine me bateri

Fuqia e baterise 20V/1.5 Ah
Depozita 0.5 Lt

AMPB251



Çmimi
1.690

Fshese rrethore pastrimi

Per lavazh

AMFB15



Çmimi
450

Kove plastike e palosshme

Per lavazhe 15 Lt

AHPH502



Çmimi
1.690

Zorre presioni

5m per lavazhe

CVLI2001

≥7kPa



Çmimi
Battery and
charger sold separately **4.900**

Aspirator makine me bateri

Vetem trup

AMSG02



Çmimi
2.390

Steke lavazhi e kompletuar

Me trup plastik

AMFP4002



Çmimi
810

Depozite shkume

Me sprucim
400 ml

AHPH5028



Çmimi
1.690

Zorre presioni

Gjatesia 5m

CVLI2026



Çmimi
3.900

Aspirator makine me bateri

11.1V, depozita 0.5 Lt
(karikim type-c)

AMSG028



Çmimi
2.690

Steke lavazhi e kompletuar

Me lidhje te shpejte

AMHB2791



Çmimi
1.450

Furce pastrimi

Per lavazh

AHPH7511



Çmimi
1.990

Tub pastrimi lavazhi

150bar/ 7.5m
per 1400w-2500w

1
2
3
4
5
6
7
8
9
10

APB30160

INGCCO



E RE



Çmimi

1.500

Furce pastrimi per pishina

Me 2 bishta te zgjatueshem
300 mm per lavazhe me bateri

K7201

ANNOVI REVERBERI
The Power of Experience



Çmimi

2.900

Steke lavazhi e kompletuar

90 cm

KC350A

ANNOVI REVERBERI
The Power of Experience



Çmimi

4.900

Salvamotor

Per lavazhe

50975

ANNOVI REVERBERI
The Power of Experience



Çmimi

1.750

E RE

Steke lavazhi model

Model 388

Filter per VC24751

INGCCO



Kodi

Te dhena

Çmimi

VC24751-SP-4

1.900

VC24751-SP-95

Rrobe

1.900

H04

ANNOVI REVERBERI
The Power of Experience



Çmimi

6.900

Zorre lavazhi Profesionale

10m, 480 bar me rakorderi
G3/8 F

Elektromotorr lavazhi

ANNOVI REVERBERI
The Power of Experience



Kodi

Te dhena

Çmimi

4391

7.5 kW / 10 Hp

65.900

4393

4 kW / 5.5 Hp

39.900

KL010

ANNOVI REVERBERI
The Power of Experience



Çmimi

4.500

E RE

Karroce per lavazh profesional

Model 2 / Model 5

Filter per VC24751

INGCCO



HEPA

Kodi

Te dhena

Çmimi

VC24751-SP-96

Rrjete

350

VCAIHP03

HEPA

1.900

20080

ANNOVI REVERBERI
The Power of Experience



Çmimi

8.900

Bypass

Per grupet RW-RK

3400260

ANNOVI REVERBERI
The Power of Experience



Çmimi

2.990

E RE

Pistolette lavazhi

Model 590

41564

ANNOVI REVERBERI
The Power of Experience



Çmimi

1.290

E RE

Koke sprucimi

Per lavazh seria 1

41563



ERE

Çmimi
1.290

Steke sprucimi

42cm seria 1 dhe 3

41560



ERE

Çmimi
2.200

Tub presioni

5m Seria 1

46327



ERE

Çmimi
1.290

Koke sprucimi

Seria 3

46328



ERE

Çmimi
1.990

Pistoletë levazhi

Seria 3

46332



ERE

Çmimi
1.590

Steke sprucimi

Seria 3 dhe 4 -5 Twin

46541



ERE

Çmimi
2.690

Tub presioni 6m

Seria 3

46330



ERE

Çmimi
1.290

Koke sprucimi

Seria Twin 4.0, 4.1Wi-Touch dhe Twin 5

47048



ERE

Çmimi
1.590

Steke sprucimi

Seria DTS 4.1 touch

46335



ERE

Çmimi
2.990

Tub presioni

8m Seria DTS 4.1 dhe 4.0 Twin

46575



ERE

Çmimi
3.590

Pistoletë levazhi

Seria 5

46576



ERE

Çmimi
2.900

Steke sprucimi

Seria 5

46581



ERE

Çmimi
9.900

Tub presioni

10m Seria 5

46844



E RE

Çmimi
1.690

Pistoletë sperkatje shkume

DHS

46846



E RE

Çmimi
2.900

Zorre spirale sperkatje shkume

DHS

46845



E RE

Çmimi
1.790

Steke sperkatje shkume

DHS

3085681



E RE

Çmimi
4.500

Fshese rrethore pastrimi

25cm Seria 3

**BOMBUL
SHKUME**

- | Me tub dhe steke
- | Depozita 50 lt
- | Valvula

Kodi BSH50

CMIMI
29.900 Lek

E RE



**BOMBUL
SHKUME**

- | Me tub dhe steke
- | Depozita 100 lt
- | Valvula

Kodi K7351

CMIMI
34.500 Lek

E RE



**BOMBUL
SHKUME**

- | Me tub dhe steke
- | Depozita 25 lt
- | Valvula

Kodi TRG25L2.0

CMIMI
19.900 Lek

E RE



**BOMBUL
SHKUME**

- | Me tub dhe steke
- | Depozita 50 lt
- | Valvula

Kodi TRG50L2.0

CMIMI
24.500 Lek

E RE



A close-up photograph of a wicker basket filled with gardening tools. Several pairs of Felco pruning shears with red handles and silver blades are scattered throughout. One pair in the upper center has the brand name 'FELCO' and 'SWISS MADE' with a Swiss flag logo on its blade. A red and black work glove with 'FELCO' printed on it is also visible. The basket contains some green foliage and a brown leather pouch. The lighting is bright, highlighting the textures of the wicker, metal, and fabric.

**GËRSHËRË KRASITJE
TUBA DHE RAKORDERI**

GERSHERE KRASITJE ME BATERI

- | Sensori inteligjent i gershereve të mbështetur nga bateria ndihmon me energji shtesë duke e bërë prerjen veçanërisht të lehtë.
- | Dizajn ergonomik për punë me te thjeshtë dhe pa lodhje.
- | Prerje e butë dhe e saktë për të mbrojtur bimët.



GERSHERE KRASITJE

- | Gershere krasitje me bateri 3.6 V
- | Kapaciteti i prerjes : 25 mm
- | Autonomia 140 min
- | Pesha : 481 gr
- | Lehtëson prerjen me dorë deri 5 here me shume

Kodi 12222-20

CMIMI
15.900 Lek



GERSHERE KRASITJE

- | Gershere krasitje me bateri
- | Kapaciteti i prerjes : 45 mm
- | Gjatesia : 295 mm
- | Pesha : 980 gr

Kodi EC1300

CMIMI
14.900 Lek



GERSHERE KRASITJE

- | Gershere krasitje me bateri 18V
- | Kapaciteti i prerjes : 28 mm
- | Teh BY PASS
- | Pesha : 800 gr
- | Me kapak mbrojtës

Kodi 34.083.00

CMIMI
8.900 Lek



Set me bateri
18 V / 4.0 + karikues



CMIMI
7.500 Lek

INGCC

GERSHERE DHE SHARRE KRASITËSE ME BATERI MOTOR PA KARBONCINA

- | Tensioni 20 V
- | Me 2 bateri 20V x 2.0 Ah
- | Prerja max 30 mm
- | Karikues i perfshire

Kodi COSLI23065E

CMIMI
14.500 Lek

P20S **BL**MOTOR



5m/s

0-20mm
0-30mm

2.0Ah
x2

INGCC

GERSHERE KRASITËSE ME BATERI MOTOR PA KARBONCINA

- | Tensioni 20 V
- | Me 1 bateri 20 x 2.0 Ah
- | Prerja max 25 mm
- | Karikues i perfshire

Kodi CSSLI202581

CMIMI
12.900 Lek

P20S **BL**MOTOR

0-20mm
0-30mm



2.0Ah
x1

INGCC

GERSHERE KRASITËSE ME BATERI MOTOR PA KARBONCINA

- | Tensioni 20 V
- | Me 1 bateri 20 x 2.0 Ah
- | Prerja max 30 mm
- | Karikues i perfshire

Kodi CSSLI203083

CMIMI
14.500 Lek

P20S **BL**MOTOR

0-20mm
0-30mm



2.0Ah
x1



GERSHERE KRASITJE

- | Gershëre krasitje hardhie.
- | Kapaciteti i prerjes : 20 mm
- | Gjatesia : 200 mm
- | Peshë : 175 gr

Kodi FELCO160S

**CMIMI
3.990 Lek**

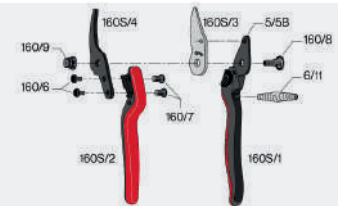

Kodi	Pershkrimi	Kodi	Pershkrimi
160/9	Bulona	160/9	Bulona
160/6	Set vida	160/6	Set vida
160S/4	Lame	160S/4	Lame
160S/2	Doreze	160S/2	Doreze
160/7	Set vida	160/7	Set vida
160S/3	Lame	160S/3	Lame

GERSHERE KRASITJE

- | Gershëre krasitje hardhie.
- | Kapaciteti i prerjes : 25 mm
- | Gjatesia : 220 mm
- | Peshë : 190 gr

Kodi FELCO160L

**CMIMI
3.990 Lek**

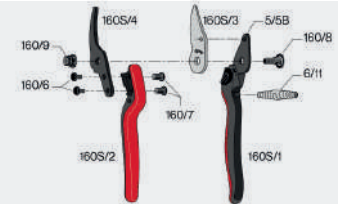

Kodi	Pershkrimi	Kodi	Pershkrimi
160/9	Bulona	160/9	Bulona
160/6	Set vida	160/6	Set vida
160S/4	Lame	160S/4	Lame
160S/2	Doreze	160S/2	Doreze
160/7	Set vida	160/7	Set vida
160S/3	Lame	160S/3	Lame

GERSHERE KRASITJE

- | Gershëre krasitje "Classic model"
- | me ingranazh.
- | Kapaciteti i prerjes : 25 mm
- | Gjatesia : 215 mm
- | Peshë : 240 gr

Kodi FELCO2

**CMIMI
7.500 Lek**

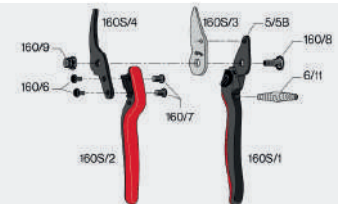

Kodi	Pershkrimi	Kodi	Pershkrimi
160/9	Bulona	160/9	Bulona
160/6	Set vida	160/6	Set vida
160S/4	Lame	160S/4	Lame
160S/2	Doreze	160S/2	Doreze
160/7	Set vida	160/7	Set vida
160S/3	Lame	160S/3	Lame

GERSHERE KRASITJE

- | Gershere krasitje "Standart model"
- | Kapaciteti i prerjes : 25 mm
- | Gjatesia : 210 mm
- | Pesha : 220 gr

Kodi FELCO4

CMIMI
5.990 Lek

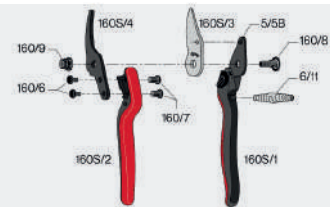

Kodi	Pershkrimi	Kodi	Pershkrimi
160/9	Bulona	160/9	Bulona
160/6	Set vida	160/6	Set vida
160S/4	Lame	160S/4	Lame
160S/2	Doreze	160S/2	Doreze
160/7	Set vida	160/7	Set vida
160S/3	Lame	160S/3	Lame

GERSHERE KRASITJE

- | Gershere krasitje "Basic Model"
- | Kapaciteti i prerjes : 25 mm
- | Gjatesia : 225 mm
- | Pesha : 310 gr

Kodi FELCO5

CMIMI
3.900 Lek



Kodi	Pershkrimi	Kodi	Pershkrimi
4/9	Bulona	5/11	Suste
5/8	Vide lame	5/13	Doreze
5/3	Lame		
5/15	Doreze		
5/5B	Set vida		
5/35	Set 2 doreza		

GERSHERE KRASITJE

- | Gershere krasitje "Basic Model"
- | Kapaciteti i prerjes : 30 mm
- | Gjatesia : 270 mm
- | Pesha : 310 gr

Kodi FELCO13

CMIMI
7.900 Lek

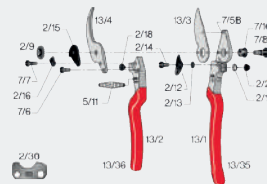

Kodi	Pershkrimi	Kodi	Pershkrimi
2/15	Pjese lame	13/3	Lame
13/4	Maje lame	7/5B	Vide maje
2/9	Bulon	7/10	Bulon
7/7	Vide lame	7/8	Vide+bulon
2/16	Pjese lame	13/16	Doreze
7/6	Vide fundore	13/35	Doreze

GERSHERE KRASITJE

- | Gershere krasitje "High Performance"
- | me ingranazh.
- | Kapaciteti i prerjes : 25 mm
- | Gjatesia : 210 mm
- | Pesha : 255 gr

Kodi FELCO11

CMIMI
7.500 Lek

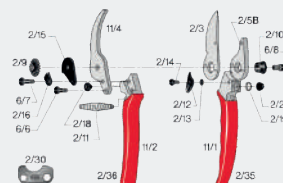

Kodi	Pershkrimi	Kodi	Pershkrimi
2/30	Bashkues	2/5B	Kundralame
2/15	Maje lame	7/5B	Maje lame
11/4	Lame	2/35	Lame
2/18	Vide lame	11/1	Vide lame
2/16	Pjese lame	2/16	Pjese lame
2/12	Pjese lame	2/20	Pjese lame

GERSHERE KRASITJE

- | Gershere krasitje "Ergonomic Compact"
- | Kapaciteti i prerjes : 20 mm
- | Gjatesia : 195 mm
- | Pesha : 210 gr

Kodi FELCO6

CMIMI
5.900 Lek

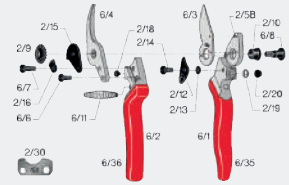

Kodi	Pershkrimi	Kodi	Pershkrimi
6/4	Lame	2/10	Bulon lame
6/3	Lame	6/8	Set vida
6/36	Doreze	2/20	Lame
6/35	Doreze	2/19	Bulon
6/2	Gomine	2/12	Mekanizem
2/5B	Vide lame	2/13	Rondele

GERSHERE KRASITJE

- | Gershere krasitje "Ergonomic"
- | Kapaciteti i prerjes : 25 mm
- | Gjatesia : 210 mm
- | Pesha : 290 gr

Kodi FELCO7

CMIMI
8.500 Lek

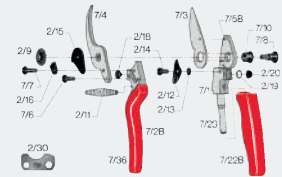

Kodi	Pershkrimi	Kodi	Pershkrimi
7/4	Set vida	7/8	Set vida
7/3	Lame	7/10	Lame
7/5B	Set vida	2/20	Set vida
7/23	Gomine	2/19	Gomine
7/22B	Doreze	2/12	Doreze
7/36	Doreze	2/13	Doreze

GERSHERE KRASITJE

- | Gershere krasitje "Ergonomic"
- | Kapaciteti i prerjes : 25 mm
- | Gjatesia : 210 mm
- | Pesha : 245 gr

Kodi FELCO8

CMIMI
6.900 Lek

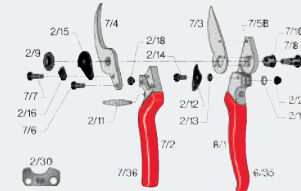

Kodi	Pershkrimi	Kodi	Pershkrimi
7/4	Lame	7/8	Set vida
7/3	Kunder lame	7/10	Lame
7/5B	Set vida	7/36	Set vida
2/30	Suport	7/2	Gomine
6/35	Doreze	2/12	Doreze
8/1	Doreze	2/13	Doreze

GERSHERE KRASITJE

- | Gershere krasitje "Anvil model"
- | me ingranazh.
- | Kapaciteti i prerjes : 25 mm
- | Gjatesia : 210 mm
- | Pesha : 225 gr

Kodi FELCO31

CMIMI
4.900 Lek

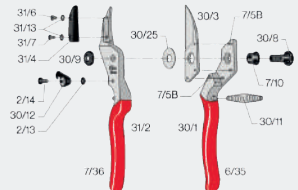

Kodi	Pershkrimi	Kodi	Pershkrimi
30/25	Set vida	30/11	Set vida
30/3	Lame	30/8	Lame
30/9	Set vida	2/14	Set vida
31/4	Gomine	30/12	Gomine
31/2	Doreze	2/13	Doreze
30/1	Doreze	7/5B	Doreze

GERSHERE KRASITJE

- | Gershere Krasitje me teh By-pass
- | Kapaciteti i prerjes : 20 mm
- | Gjatesia : 210 mm
- | Pesha : 220 gr

Kodi 10930

CMIMI
3.990 Lek

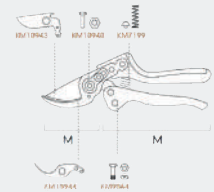

Kodi	Pershkrimi
KM7199	Set vide dhe suste
KM9064	Vide per dorezen
KM10940	Vide qendrore
KM10943	Lame
KM10944	Kunder lame

GERSHERE KRASITJE

- | Gershere Krasitje Medium
- | Kapaciteti i prerjes : 20 mm
- | Gjatesia : 210 mm
- | Pesha : 220 gr

Kodi 4229

CMIMI
3.590 Lek

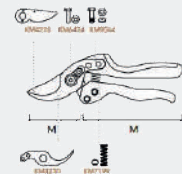

Kodi	Pershkrimi
KM7199	Set vide dhe suste
KM6424	Vide qendrore
KM4228	Lame
KM4230	Kunder lame

GERSHERE KRASITJE

- | Gershere krasitje alumini me teh SK-5
- | Kapaciteti i prerjes : 25 mm
- | Gjatesia : 210 mm
- | Pesha : 260 gr

Kodi 9717

CMIMI
3.500 Lek

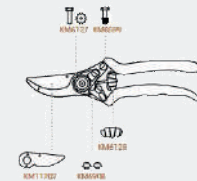

Kodi	Pershkrimi
KM8599	Set vide
KM6128	Suste
KM6127	Vide qendrore
KM6908	Fermo
KM11202	Lama

GERSHERE KRASITJE

- | Gershere krasitje alumini me teh SK-5
- | Kapaciteti i prerjes : 25 mm
- | Gjatesia : 210 mm
- | Pesha : 250 gr

Kodi 6067

CMIMI
3.790 Lek

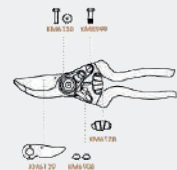

Kodi	Pershkrimi
KM8599	Set vide
KM6128	Suste
KM6127	Vide qendrore
KM6908	Fermo
KM11202	Lama

GERSHERE KRASITJE

- | Gershere krasitje alumini me teh inoxi KM-12
- | Kapaciteti i prerjes : 20 mm
- | Gjatesia : 200 mm
- | Pesha : 205 gr

Kodi 6069

CMIMI
1.990 Lek



GERSHERE KRASITJE

- | Gershere Krasitje me teh By-pass KM-1
- | Kapaciteti i prerjes : 25 mm
- | Gjatesia : 210 mm
- | Pesha : 260 gr

Kodi 13803P

CMIMI
3.900 Lek



GERSHERE KRASITJE

- | Gershere krasitese me teh inoxi me hark
- | Ideale per vjelje
- | Gjatesia : 170 mm
- | Pesha : 120 gr

Kodi 1097

CMIMI
990 Lek

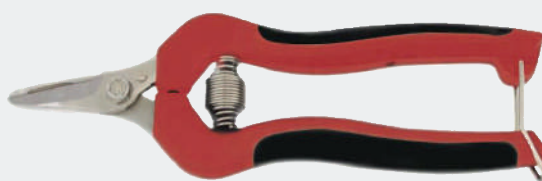

GERSHERE KRASITJE

- | Gershere krasitese me teh inoxi te drejte
- | Ideale per vjelje
- | Gjatesia : 190 mm
- | Pesha : 140 gr

Kodi 1104

CMIMI
990 Lek



1
2
3
4
5
6
7
8
9
10

GERSHERE KRASITJE

- ▮ Kapaciteti i prerjes 18 mm
- ▮ Për prerjen e kercejve të thatë

Kodi 8754-20

MADE IN GERMANY

CMIMI
1.700 Lek



GERSHERE KRASITJE

- ▮ Kapaciteti i prerjes 20 mm
- ▮ Për prerjen e kercejve të njomë

Kodi 8854-20

MADE IN GERMANY

CMIMI
1.990 Lek

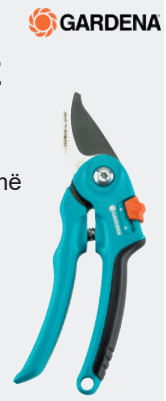

GERSHERE KRASITJE

- ▮ Kapaciteti i prerjes 18 mm
- ▮ Për prerjen e kercejve të njomë

Kodi 8855-20

MADE IN GERMANY

CMIMI
2.100 Lek



GERSHERE KRASITJE

- ▮ Kapaciteti i prerjes 22 mm
- ▮ Për prerjen e luleve, fidanëve dhe kercejve të njome

Kodi 8857-20

MADE IN GERMANY

CMIMI
2.200 Lek

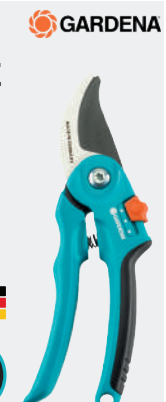

GERSHERE KRASITJE

- ▮ Kapaciteti i prerjes 23 mm
- ▮ Për prerjen e degëve të vjetra, të trasha dhe të thata

Kodi 8903-20

MADE IN GERMANY

CMIMI
2.900 Lek



GERSHERE KRASITJE

- ▮ Kapaciteti i prerjes 24 mm
- ▮ Për prerjen e luleve, fidanëve dhe dru të freskët

Kodi 8904-20

MADE IN GERMANY

CMIMI
2.900 Lek



GERSHERE KRASITJE

- ▮ Kapaciteti i prerjes 24 mm
- ▮ Për prerjen e degëve të njoma

Kodi 8905-20

MADE IN GERMANY

CMIMI
3.900 Lek



GERSHERE KRASITJE

- ▮ Kapaciteti i prerjes 24 mm
- ▮ Për prerjen e luleve, fidanëve dhe dru të freskët

Kodi 8906-20

MADE IN GERMANY

CMIMI
4.500 Lek





GERSHERE KRASITJE

- ▮ Kapaciteti i prerjes 22 mm
- ▮ Për prerjen e luleve, fidanëve dhe dru të freskët

Kodi 8702-20

MADE IN GERMANY



CMIMI
5.900 Lek



GERSHERE KRASITJE

- ▮ Kapaciteti i prerjes 22 mm
- ▮ Për prerjen e degëve të trasha dhe të thata

Kodi 8798-20

MADE IN GERMANY



CMIMI
6.300 Lek



GERSHERE KRASITJE

- ▮ Kapaciteti i prerjes 16 mm
- ▮ Teh me sipërfaqe që nuk ngjit
- ▮ Për prerjen e degëve dhe fidaneve të lagura

Kodi 40-414

CMIMI
1.400 Lek



GERSHERE KRASITJEJE

- ▮ GERSHERE krasitje me bypass
- ▮ Teh me sipërfaqe që nuk ngjit
- ▮ Me bypass 10-18 mm

Kodi 41-020

CMIMI
1.950 Lek



GERSHERE KRASITJE

- ▮ GERSHERE krasitje metalike
- ▮ Teh çeliku i fortë, i kromuar
- ▮ Me bypass 22 mm

Kodi 40-417

CMIMI
2.450 Lek



GERSHERE KRASITJEJE

- ▮ GERSHERE krasitje metalike Anvil
- ▮ Teh çeliku i fortë, i kromuar
- ▮ Me bypass 22 mm

Kodi 40-418

CMIMI
2.900 Lek





GERSHERE KRASITJE

- ▮ Kapaciteti i prerjes 12 mm
- ▮ Gjatesia 200 mm

Kodi HPS0109

CMIMI
550 Lek



GERSHERE KRASITJE

- ▮ Kapaciteti i prerjes 12 mm
- ▮ Gjatesia 200 mm

Kodi HPS0201

CMIMI
490 Lek



GERSHERE KRASITJE

- ▮ Kapaciteti i prerjes 16 mm
- ▮ Gjatesia 220 mm

Kodi HPS0601

CMIMI
690 Lek



GERSHERE KRASITJE

- ▮ Kapaciteti i prerjes 16 mm
- ▮ Gjatesia 200 mm

Kodi HPS0308

CMIMI
890 Lek



GERSHERE KRASITJE

- ▮ Gjatesia 200 mm
- ▮ Kapaciteti i prerjes 15 mm

Kodi 99230

CMIMI
490 Lek



**GERSHERE KRASITJE
UNIVERSALE**

- ▮ Gjatesia 205 mm
- ▮ Kapaciteti i prerjes 20 mm

Kodi 99204

CMIMI
550 Lek



WADFCW

GERSHERE KRASITJE

- | Permasa 200 mm
- | 8"

Kodi WPA1E08

CMIMI
390 Lek



GARDENA

GERSHERE MULTIFUNKSIONALE

- | Gjatesia 210 mm
- | Për prerjen e erzave, luleve te vogla etj

Kodi 8705-20

CMIMI
2.900 Lek

MADE IN GERMANY



FLO

GERSHERE LULESH

- | Gjatesia 165 mm
- | Me teh te drejte

Kodi 99182

CMIMI
150 Lek



FLO

GERSHERE LULESH

- | Gjatesia 170 mm
- | Me teh te rumbullaket

Kodi 99180

CMIMI
190 Lek



FLO

GERSHERE RRUSHI DHE LULESH

- | Gjatesia 190 mm
- | Me teh SK5

Kodi 99240

CMIMI
450 Lek



FELCO

SHKOP TELESKOPIK

- | Shkop teleskopik per Gersher krasitje
- | Materiali Alumin
- | Gjatesia : 150-350 cm
- | Pesha: 1.4 kg

Kodi 880/100-150

CMIMI
29.000 Lek



FELCO

SET MIREMBAJTJE

- | Per gershere krasitje
- | Felco 812

Kodi 812/916

CMIMI
7.500 Lek



FELCO

SET MIREMBAJTJE

- | Per gershere krasitje
- | Felco 822

Kodi 822/916

CMIMI
7.900 Lek



XHEP LEKURE

- Per mbajtjen e gershereve
- Felco



Kodi FELCO932

CMIMI
1.500 Lek



GERSHERE BARI



- Gjatesia 180 mm
- Tehu i galvanizuar

MADE IN GERMANY 

25
ANËTË - 25 VITE GARANTIE

Kodi 8730-30

CMIMI
2.490 Lek



GERSHERE BARI ME KOKE TE RROTULLUESHME



- Gjatesia 180 mm
- Kendi 360°

Kodi 8731-30

MADE IN GERMANY 

25
ANËTË - 25 VITE GARANTIE

CMIMI
2.790 Lek



GERSHERE BARI ME BISHT



- Rrota levizese
- Kendi 90°

Kodi 12100-20

MADE IN GERMANY 

25
ANËTË - 25 VITE GARANTIE

CMIMI
4.990 Lek



GERSHERE BARI



- Kendi 340°
- Gjatesia 180 mm

Kodi HPS3401

CMIMI
790 Lek



GERSHERE BARI



- Kokë e rrumbullakët
- Tehu: 13 cm
- Për prerjen e skajeve të lëndinave

Kodi 40-405

CMIMI
1.990 Lek



GERSHERE BARI



- Gjatesia 300 mm
- Materiali: Celik Karboni

Kodi 99301

CMIMI
590 Lek

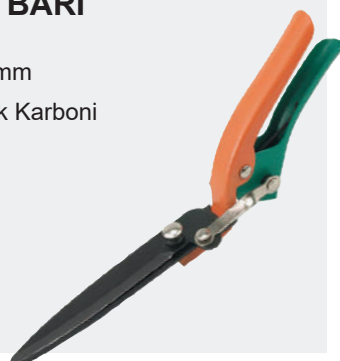

GERSHERE KRASITJE

- | Kapaciteti i prerjes 45 mm
- | Gjatesia 840 mm

Kodi FELCO22

CMIMI
19.500 Lek



GERSHERE KRASITJE

- | Kapaciteti i prerjes 25 mm
- | Gjatesia 210 mm

Kodi FELCO211-60

CMIMI
9.900 Lek



GERSHERE KRASITJE

- | Kapaciteti i prerjes 32 mm
- | Gjatesia 600 mm

Kodi 6577

CMIMI
3.900 Lek



GERSHERE KRASITJE

- | Kapaciteti i prerjes 42 mm
- | Gjatesia totale 500 mm

Kodi 12002-20

CMIMI
4.990 Lek

MADE IN GERMANY



GERSHERE KRASITJE

- | Kapaciteti i prerjes 42 mm
- | Gjatesia totale 680 mm

Kodi 12003-20

CMIMI
5.900 Lek

MADE IN GERMANY



GERSHERE KRASITJE TELESKOPIKE

- | Kapaciteti i prerjes 42 mm
- | Gjatesia totale 520-670 mm

Kodi 12005-20

CMIMI
6.900 Lek

MADE IN GERMANY



GERSHERE KRASITJE ME INGRANAZH

- | Kapaciteti i prerjes 42 mm
- | Gjatesia totale 600 mm

Kodi 12006-20

CMIMI
7.900 Lek

MADE IN GERMANY



GERSHERE KRASITJE TELESKOPIKE

- | Kapaciteti i prerjes 42 mm
- | Gjatesia totale 650-900 mm

Kodi 12009-20

CMIMI
8.900 Lek

MADE IN GERMANY





**GERSHERE KRASITJE
ME INGRANAZH**

- | Kapaciteti i prerjes 42 mm
- | Gjatesia totale 750 mm

Kodi 12008-20

MADE IN
GERMANY

CMIMI
9.500 Lek



GERSHERE KRASITJE

- | GERSHERE degësh alumini
- | Teh me sipërfaqe që nuk ngjit
- | Me bypass 45 mm

Kodi 40-411

CMIMI
5.900 Lek



GERSHERE KRASITJE

- | Gershere degësh alumini teleskopike
- | Kapaciteti i prerjes: 700-1010 mm
- | Me bypass 45 mm

Kodi 40-410

CMIMI
6.990 Lek



GERSHERE KRASITJE

- | Gershere degësh me Anvil
- | Teh me sipërfaqe që nuk ngjit
- | Gjatesia totale 690 mm

Kodi 99112

CMIMI
990 Lek



GERSHERE KRASITJE

- | Gershere degësh me Anvil
- | Me bypass: 30 mm
- | Gjatesia totale 660 mm

Kodi 99109

CMIMI
1.450 Lek



GERSHERE KRASITJE

- | Gershere krasitje
- | Me bypass: 45 mm
- | Gjatesia totale 700 mm

Kodi 99111

CMIMI
1.690 Lek



GERSHERE KRASITJE

- | Kapaciteti i prerjes 23 mm
- | Gjatesia 725 mm

Kodi HLT7101

CMIMI
1.250 Lek



GERSHERE KRASITJE

- | Kapaciteti i prerjes 40 mm
- | Gjatesia 760 mm

Kodi HLT7608

CMIMI
1.990 Lek



INGCC
GERSHERE KRASITJE

- ▮ Kapaciteti i prerjes 25 mm
- ▮ Gjatesia totale 760 mm

Kodi HLT7401

CMIMI
1.690Lek



INGCC
GERSHERE KRASITJE

- ▮ Kapaciteti i prerjes 27 mm
- ▮ Gjatesia 690 mm

Kodi HLT72011

CMIMI
990 Lek



INGCC
GERSHERE KRASITJE TELESKOPIKE

- ▮ Kapaciteti i prerjes 25 mm
- ▮ Gjatesia 660-860 mm

Kodi HLTS7401

CMIMI
1.950 Lek



INGCC
GERSHERE KRASITJE TELESKOPIKE

- ▮ Kapaciteti i prerjes 40 mm
- ▮ Gjatesia 650-850 mm

Kodi HLTS7608

CMIMI
1.990 Lek



WADFOW
GERSHERE KRASITJE

- ▮ Kapaciteti i prerjes 18 mm
- ▮ Gjatesia 690 mm

Kodi WPR1301

CMIMI
890 Lek



INGCC
SET ME 3 GERSHERE

- ▮ Gershere krasitje dore 8.5"
- ▮ Gershere ligustrash 23"
- ▮ Gershere krasitje 29"

Kodi HLT76033

CMIMI
2.500 Lek



1
2
3
4
5
6
7
8
9
10

GERSHERE LIGUSTRASH

- | Gjatesia totale 535 mm
- | Gjatesia tehut 230 mm

Kodi 12300-20

CMIMI
3.950 Lek

MADE IN GERMANY



GARDENA



GERSHERE LIGUSTRASH

- | Gjatesia totale 407 mm
- | Gjatesia tehut 180 mm

Kodi 12302-20

CMIMI
3.900 Lek

MADE IN GERMANY



GARDENA



GERSHERE LIGUSTRASH

- | Gjatesia totale 537 mm
- | Gjatesia tehut 200 mm

Kodi 12301-20

CMIMI
5.900 Lek

MADE IN GERMANY



GARDENA



GERSHERE LIGUSTRASH TELESKOPIKE

- | Gjatesia totale 700-900 mm
- | Gjatesia tehut 230 mm

Kodi 12304-20

CMIMI
6.900 Lek

MADE IN GERMANY



GARDENA



GERSHERE LIGUSTRASH ME INGRANAZH

- | Gjatesia totale 600 mm
- | Gjatesia tehut 230 mm

Kodi 12303-20

CMIMI
6.900 Lek

MADE IN GERMANY



GARDENA



GERSHERE LIGUSTRASH

- | Gjatesia totale 50 mm
- | Gjatesia tehut 250 mm

Kodi 395-20

CMIMI
7.900 Lek

MADE IN GERMANY



GARDENA



GERSHERE LIGUSTRASH

- | Materiali Alumin
- | Gjatesia 400 mm

Kodi 8842

CMIMI
5.800 Lek

Kamikaze
Performance in your hand



GERSHERE LIGUSTRASH ME INGRANAZH

- | Gershere ligustrash alumini
- | Tehu: 20 cm IDEAL
- | Për prerjen e shkurreve, pemëve të vogla dhe gardheve

Kodi 40-401

CMIMI
4.500 Lek

cellfast





GERSHERE LIGUSTRASH ME INGRANAZH TELESKOPIKE

- | Gershere ligustrash alumini teleskopike
- | Tehu: 20 cm IDEAL
- | Për prerjen e shkurreve, pemëve të vogla dhe gardheve

Kodi 40-400
CMIMI
5.500 Lek



GERSHERE LIGUSTRASH

- | Gershere ligustrash 550 mm
- | Tehu: 24 cm
- | Për prerjen e shkurreve, pemëve të vogla dhe gardheve

Kodi 99005
CMIMI
990 Lek



GERSHERE LIGUSTRASH

- | Kapaciteti i prerjes 10 mm
- | Gjatesia 557 mm

Kodi HHS6001
CMIMI
1.350 Lek



GERSHERE LIGUSTRASH

- | Kapaciteti i prerjes 10 mm
- | Gjatesia 557 mm

Kodi HHS6301
CMIMI
1.250 Lek



GERSHERE LIGUSTRASH TELESKOPIKE

- | Kapaciteti i prerjes 10 mm
- | Gjatesia 710-860 mm

Kodi HHS6306
CMIMI
1.690 Lek



GERSHERE LIGUSTRASH

- | Kapaciteti i prerjes 10 mm
- | Gjatesia 550 mm

Kodi HHS62011
CMIMI
990 Lek



GERSHERE LIGUSTRASH

- | Kapaciteti i prerjes 10 mm
- | Gjatesia 550 mm

Kodi WPR2301
CMIMI
890 Lek



SET ME 3 GERSHERE

- | Gershere krasitje dore 8"
- | Gershere ligustrash 22"
- | Gershere krasitje 27"

Kodi HLT78033
CMIMI
1.990 Lek



SHARRE KRASITJE

E RE

- | SHARRE KRASITJE ME PALOSJE
- | Kapaciteti i prerjes: 60 mm
- | Gjatesia e tehut: 120 mm

Kodi Felco-601

**CMIMI
2.890 Lek**



SHARRE KRASITJE

E RE

- | SHARRE KRASITJE ME PALOSJE
- | Kapaciteti i prerjes: 80 mm
- | Gjatesia e tehut: 160 mm

Kodi Felco-602

**CMIMI
2.990 Lek**



SHARRE KRASITJE

- | Sharre krasitese me lama te drejta
- | Kapaciteti i prerjes : 100 mm
- | Gjatesia : 500 mm
- | Pesha : 370 gr

Kodi FELCO611

**CMIMI
5.900 Lek**



SHARRE KRASITJE

- | Sharre krasitese me lama te harkuar
- | Kapaciteti i prerjes : 120 mm
- | Gjatesia : 496 mm
- | Pesha : 400 gr

Kodi FELCO630

**CMIMI
6.900 Lek**



SHARRE KRASITJE

- | Sharre krasitese me lama te harkuar
- | Kapaciteti i prerjes : 100 mm
- | Gjatesia : 437 mm
- | Pesha : 365 gr

Kodi FELCO640

**CMIMI
4.900 Lek**



SHARRE KRASITJE

- | Sharre dore e drejte
- | Kapaciteti i prerjes : 60 mm
- | Gjatesia : 240 mm

Kodi 2970

**CMIMI
2.990 Lek**



SHARRE KRASITJE

- | Sharre dore e drejte
- | Kapaciteti i prerjes : 80 mm
- | Gjatesia : 300 mm

Kodi 2977

CMIMI
3.500 Lek



SHARRE KRASITJE

- | Sharre dore me hark
- | Kapaciteti i prerjes : 80 mm
- | Gjatesia : 330 mm

Kodi 2981

CMIMI
3.500 Lek



SHARRE KRASITJE

- | Sharre e palosshme krasitje e drejte
- | Kapaciteti i prerjes : 50 mm
- | Gjatesia : 180 mm

Kodi 8967

CMIMI
2.490 Lek



SHARRE KRASITJE

- | Sharre dore me hark dhe bisht teleskopik
- | Kapaciteti i prerjes : 80 mm
- | Lartesia : 300 mm

Kodi 8509

CMIMI
7.900 Lek



SHARRE ME BISHT TELESKOPIK

- | Sharre krasitese me hark dhe bisht teleskopik
- | Kapaciteti i prerjes : 50 mm
- | Gjatesia : 6 m

Kodi 9249

CMIMI
9.900 Lek



INGCO

SHARRE TELESKOPIKE

- | Sharre krasitese me hark dhe bisht teleskopik
- | Kapaciteti i prerjes : 50 mm
- | Gjatesia : 280 cm

Kodi HEPS25281

CMIMI
2.500 Lek



MAXφ
25mm

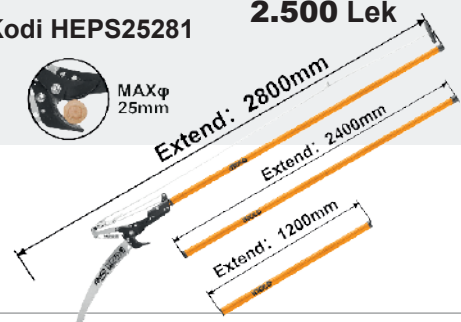

SHARRE KRASITJE



- | Sharre Krasitese me palosje
- | Gjatesia : 135 mm
- | Dhëmbë preciz me mprehje të 3-fishtë.
Dorezë me gominë

Kodi 8742-20

CMIMI
3.990 Lek



SHARRE KRASITJE



- | Sharre Krasitese me palosje
- | Gjatesia : 200 mm
- | Dhëmbë preciz me mprehje të 3-fishtë.
Dorezë me gominë

Kodi 8743-20

CMIMI
5.500 Lek



SHARRE KRASITJE



- | Sharre krasitese
- | Gjatesia : 400 mm
- | Dhëmbë preciz me mprehje të 3-fishtë.
Dorezë me gominë

Kodi 8745-20

CMIMI
5.500 Lek



SHARRE KRASITJE



- | Sharre krasitje CombiSystem
- | Gjatesia : 325 mm
- | Kombinohet me bishtat teleskopikë.
Teh i kromuar

Kodi 8737-20

CMIMI
3.690 Lek



SHARRË KRASITËSE E DREJTË



- | Gjatësia : 300 mm

Kodi 41-040

CMIMI
2.650 Lek



SHARRË KRASITËSE E PALOSSHME



- | Gjatësia : 250 mm

Kodi 41-041

CMIMI
2.950 Lek





SHARRE KRASITJESË DRURI

Gjatesia : 250 mm

Kodi 28640

**CMIMI
390 Lek**



SHARRE KRASITJESË E PALOSSHME

Gjatesia : 180 mm

Kodi 28641

**CMIMI
490 Lek**



SHARRE KRASITJË

Sharre krasitje e palosshme

Tehu : 65 mn

Gjatesia : 180 mm

180mm(7")

Kodi HFSW18028C

**CMIMI
490 Lek**



SHARRE KRASITJË



Sharre krasitje e palosshme

Tehu : 65 mn

Gjatesia : 180 mm

180mm(7")

Kodi HFSW1808

**CMIMI
690 Lek**

TAIWAN



SHARRE KRASITJË



Sharre krasitje e harkuar

Tehu : 65 mn

Gjatesia : 330 mm

Kodi HPS33028C

**CMIMI
590 Lek**



SHARRE KRASITJË



Sharre dore e drejte

Tehu : 65 mn

Gjatesia : 300 mm

Kodi HPS30028C

**CMIMI
590 Lek**



SHARRE KRASITJË



Sharre dore e drejte

Tehu : 65 mn

Gjatesia : 300 mm

Kodi HPS3008

**CMIMI
890 Lek**

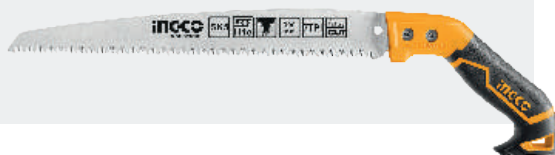

SHARRE KRASITJË



Sharre dore me hark

Tehu : 65 mn

Gjatesia : 330 mm

Kodi HPS3308

**CMIMI
890 Lek**



SHARRE KRASITJE



- | Sharre dore palosshme
- | Tehu : 65 mn
- | Gjatesia : 180 mm

Kodi WHW4607

CMIMI
450 Lek



SHARRE KRASITJE



- | Sharre dore e drejte
- | Tehu : 65 mn
- | Gjatesia : 270 mm

Kodi WHW5G12

CMIMI
490 Lek



SHARRE KRASITJE



- | Sharre dore me hark
- | Tehu : 65 mn
- | Gjatesia : 300 mm

Kodi WHW7G12

CMIMI
490 Lek



SHARRË DORE ME HARK

- | Sharre dore me hark për dru
- | Gjatesia : 760 mm

Kodi 8748-20

CMIMI
3.900 Lek



SHARRË DORE ME HARK

- | Sharre dore me hark për dru
- | Gjatesia : 610 mm

Kodi 40-421

CMIMI
1.990 Lek



SHARRË DORE ME HARK

- | Sharre dore me hark për dru
- | Gjatesia : 533 mm

Kodi 40-420

CMIMI
1.890 Lek



SOPATË UNIVERSALE

- | Pesha 1100 g
- | Gjatesia 450 mm

Kodi 41-002

CMIMI
5.500 Lek



SOPATË UNIVERSALE

- | Pesha 1600 g
- | Gjatesia 615 mm

Kodi 41-003

CMIMI
6.500 Lek



SOPATË UNIVERSALE

- | Pesha 1200 g
- | Gjatesia 450 mm

Kodi 41-004

CMIMI
6.500 Lek



SOPATË UNIVERSALE

- | Pesha 1600 g
- | Gjatesia 615 mm

Kodi 41-005

CMIMI
6.500 Lek



SOPATË UNIVERSALE

- | Pesha 2000 g
- | Gjatesia 740 mm

Kodi 41-006

CMIMI
7.500 Lek



SOPATË UNIVERSALE

- | Pesha 2500 g
- | Gjatesia 740 mm

Kodi 41-007

CMIMI
7.500 Lek



SOPATE UNIVERSALE

- | Pesha 600 gr
- | Gjatesia 390 mm

Kodi HAX02010008

CMIMI
990 Lek



SOPATE UNIVERSALE

- | Pesha 1000 gr
- | Gjatesia 430 mm

Kodi HAX02060008

CMIMI
1.350 Lek



INGCO
SOPATE UNIVERSALE

- | Pesha 1250 gr
- | Gjatesia 700 mm

Kodi HAX02012508
**CMIMI
1.990 Lek**

LOPATE E DREJTE "IDEAL"

- | Gjatesia e bishtit: 1195 mm
- | Materiali celik

Kodi 40-201
**CMIMI
2.900 Lek**

LOPATE "IDEAL"

- | Gjatesia e bishtit: 1160 mm
- | Me bisht fibre

Kodi 40-202
**CMIMI
2.900 Lek**

LOPATE ME MAJE

- | Gjatesia totale 1170 mm
- | Me bisht alumini

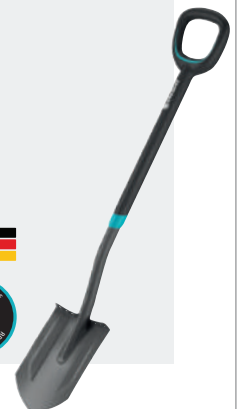
Kodi 17010-20
**CMIMI
5.900 Lek**
**MADE IN
GERMANY**
25
ANNO GARANTIE
QUALITA' 2012 - 2017

LOPATE METALIKE

- | Gjatesia e bishtit: 1200mm
- | Me bisht fibre

Kodi 35835
**CMIMI
1.500 Lek**

LOPATE DHE KAZME

- | Metalike me palosje
- | 12x46.5cm

Kodi 40-007
**CMIMI
1.450 Lek**

SFURK METALIK "IDEAL"

- | Gjatesia e bishtit: 1280mm
- | Me bisht fibre

Kodi 40-221
**CMIMI
3.500 Lek**

SFURK METALIK

- | Gjatesia e bishtit: 1200mm
- | Me bisht fibre

Kodi 35892
**CMIMI
1.590 Lek**

INGCO

PRASHITES TOKE

- | Permasa 290x75x8 mm
- | Materiali celik

Kodi HGT979K

CMIMI
350 Lek



INGCO

SFURK I VOGEL

- | Permasa 320 mm
- | Materiali celik

Kodi HFTF38

CMIMI
250 Lek



INGCO

KREHER KOPSHTI

- | Permasa 290x75x8 mm
- | Materiali celik

Kodi HFTR1008

CMIMI
350 Lek



INGCO

LOPATE KOPSHTI

- | Permasa 340 mm
- | Materiali celik

Kodi HFTT858

CMIMI
350 Lek



FLO

KREHER METALIK

- | Me koke te rregullueshme
- | Pa bisht

Kodi 99401

CMIMI
350 Lek



GARDENA

KREHER GJETHESH

- | Per ti mbledhur
- | Me rregullim

Kodi 3103-20

CMIMI
2.990 Lek



FLO

MBJELLES FIDANESH

- | Mbajtese doreze plastike
- | Materiali celik
- | Pesha 0.275 kg

Kodi 99033

CMIMI
290 Lek



cellfast

MBJELLES FIDANESH

- | Mbajtese doreze plastike
- | Materiali celik
- | 182x243x134 mm

Kodi 42-261

CMIMI
750 Lek



LOPATE KOPSHTI

- | Lopate Kopshti
- | E zeze

Kodi 42-031

CMIMI
490 Lek



SET ME 3 VEGLA KOPSHTARIE

- | Vegla kopshtarie
- | 3 cope

Kodi 40-058

CMIMI
990 Lek



PRASHITES KOPSHTI

- | 308 x 197 x 85 cm
- | Materiali Plastik

Kodi 42-037

CMIMI
590 Lek



LOPATE KOPSHTI

- | Permasa 330 mm
- | Materiali celik

Kodi 99034

CMIMI
290 Lek



SET ME 3 VEGLA KOPSHTARIE

- | Bisht druri
- | Materiali celik

Kodi 99028

CMIMI
450 Lek



KREHER KOPSHTI

- | Permasa 330 mm
- | Me 5 tehe

Kodi 99036

CMIMI
290 Lek



LOPATE E PALOSSHME

- | Permasa 410 mm
- | Materiali celik

Kodi 99054

CMIMI
990 Lek



PRASHITES KOPSHTI

- | Permasa 300 mm
- | Materiali celik

Kodi 99037

CMIMI
350 Lek



FC-8101



Çmimi
1.500

Lidhese rrushi / perimesh jeshile me rrip plastik

Ngjyra

Jeshile

FC-8104

Përdorimi i gjerë: Ky mjet profesional për lidhësin e makinerisë së bimëve mund të përdoret për lloje të ndryshme bimësh, si rrush, domate, tranguj, speca, lule, etj.



Çmimi
1.600

Lidhese rrushi / perimesh me thike + suste rezerve

Ngjyra

Portokalli

FC-8106

Lidhesja e rrushit dhe perimeve FC-8106 është prej çeliku me cilësi të lartë, e qëndrueshme dhe e lehtë për t'u mbajtur dhe për t'u përdorur. Kjo lidhëse mund të përdoret me shirit 60 metra, e përkryer për lidhjen e të gjitha hardhive.



Çmimi
1.700

Lidhese rrushi / perimesh me rrip plastik Profi.

Ngjyra

Portokalli

FC-8102



Çmimi
1.500

Lidhese rrushi / perimesh e verdhe me rrip plastik

Ngjyra

Mikse

FC-8105

Fidanishtet, kultivuesit e pemëve, vreshtat dhe pemishtet të gjithë përjetojnë potencialin e kursimit të kohës me lidhësen e rrushit dhe perimeve.



Çmimi
1.600

Lidhese rrushi / perimesh e kuqe

Ngjyra

E kuqe

FC-8107

Lidhesja e rrushit dhe perimeve FC-8107 është e pajisur me një trup unik, të qëndrueshëm dhe rezistent ndaj ndryshkut, i cili përmirëson shumë efikasitetin tuaj të punës, kursen kostot e punës dhe kursen kohë. Kjo makineri shërben për lidhjen e rrushit, domateve e shume perimeve te tjera ne kopshtin tuaj.



Çmimi
1.700

Lidhese rrushi / perimesh e zeze Profi Line

Ngjyra

E kuqe

FC-8201



Çmimi
850

Gershëre për shartese

Paketimi 1 cope

FC-8202



Çmimi
1.350

Gershëre shartimi set

Paketimi valixhe

FC-8231



Çmimi
1.900

Gershëre për shartese metalike

Materiali Inox

99250



Çmimi
1.350

Gershëre shartimi dhe krasitje 2 në 1

Paketimi 1 cope

40-260



Çmimi
990

Thike shartimi me tëh celiku

Permasa 17 cm



Shirit për lidhjen e bimeve

Kodi	Ngjyra	Çmimi
FC-8801-1	E kuqe	45
FC-8801-2	Blu	45
FC-8801-3	Jeshile	45
FC-8801-4	E bardhe	45

FC-8901



Çmimi
150

Kapese metalike për lidhese rrushi

Permasa 6 mm x 4 mm

FC-8281



Çmimi
90

Shirit për shartimin e bimeve

Permasa 3 cm x 100 m

FC-8251

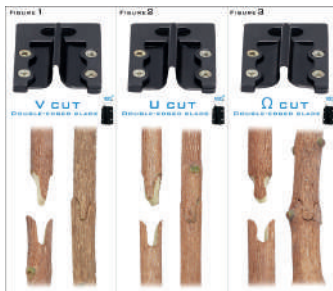

Çmimi
150

Thike gershëre shartimi

Seti 3 cope

FC-8831



FC-8908



Thika rezerve

Kodi	Paketimi	Çmimi
FC-8831	1 cope	590
FC-8908	1 cope	100

88806



Çmimi
190

Tel për lidhje rrushi

Mbrojtëse plastike 50 m

Karroca uji GARDENA

Karrocat e duhura te ujit per cdo permase kopshti

Gama jone e gjere dhe e mirestrukturuar e produkteve e ben zgjedhjen tuaj me te thjeshte.

Per me teper, te gjitha karrocet tona CleverRoll jane kunder ngrices.

Cilesi Gjermane per jetegjatesi me te larte.

MADE IN GERMANY



Seria CleverRoll

S



CleverRoll S - per kopshte te vogla

- Max 40 m zorre 13 mm (1/2")
- Model kompakt me lartesi doreze te ndryshueshme

M



CleverRoll M - per kopshte me madhesi mesatare

- Max. 60 m zorre 13 mm (1/2")
- Stabilitet maksimal fale sistemit Kick&Stand
- Gjithashtu edhe ne versionin me skelet metalik

L



CleverRoll L Easy - per kopshte te medha

- Max 100 m zorre 13 mm (1/2")
- Stabilitet maksimal fale sistemit Kick&Stand
- Me guide metalike te zorres per rrotullim preciz
- Gjithashtu dhe ne versionin metalik



Magazinim kompakt

Thjesht leshoni leven pershtasni lartesine dhe me pas mbylleni leven serisht



Rrotullim perfekt

Ergonomike, rehatshme, e thjeshte ne rrotullim. Palosje e shpejte per te ruajtur hapesine magazinimi



Stabilitet i larte fale sistemit Kick&Stand

Fale kembeszes se jashtme mbeshtetese karroca nuk do te rrezohet. Forma e saj speciale plus rrotat me te medhaja sigurojne suport shtese per karrocen e zorres se ujit. Thjeshte palosni kembezen mbeshtetese kur deshironi ta magazinimi.



TUBA UJI & RAKORDERI



KARROCE UJI ME RAKORDERI

- | Diametri 1/2"
- | Gjatesia 15 m



Kodi 2687-20

CMIMI
6.900 Lek



KARROCE UJI AQUAROLL S

- | Diametri 1/2"
- | Gjatesia 20 m



Kodi 18502-20

CMIMI
8.500 Lek



KARROCE ME ZORRE UJI ME RAKORDERI

- | Diametri 1/2"
- | Gjatesia 20 m



Kodi 2691-20

CMIMI
8.500 Lek



KARROCE UJI ME RROTA PA ZORRE

- | Diametri 1/2" 100 m
- | Diametri 5/8" 80 m
- | Diametri 3/4" 100 m



Kodi 18511-20

CMIMI
9.500 Lek



KARROCE UJI METALIKE PA ZORRE

- | Diametri 1/2" 100 m
- | Diametri 5/8" 80 m
- | Diametri 3/4" 50 m



Kodi 18541-20

CMIMI
11.900 Lek



KARROCE UJI METALIKE PA ZORRE

- | Diametri 1/2" 100 m
- | Diametri 5/8" 80 m
- | Diametri 3/4" 50 m



Kodi 18520-20

CMIMI
12.900 Lek



1
2
3
4
5
6
7
8
9
10



**KARRUKULL UJI
AUTOMATIKE**

MADE IN GERMANY

- | Diametri 1/2"
- | Gjatesia 15 m



Kodi 18600-20

**CMIMI
19.900 Lek**



**KARRUKULL UJI
AUTOMATIKE**

MADE IN GERMANY

- | Diametri 1/2"
- | Gjatesia 25 m

Kodi 18620-20

**CMIMI
29.900 Lek**



**KARRUKULL UJI
AUTOMATIKE ERGO**

- | Diametri 1/2"
- | Gjatesia 20 m

Kodi 55-410

**CMIMI
19.500 Lek**



**KARROCE UJI ALUMINI
SET DISCOVER**

- | Diametri 1/2"
- | Gjatesia 20 m

Kodi 55-620

**CMIMI
9.500 Lek**



**KARROCE UJI
ALUPLUS IDEAL**

- | Diametri 1/2"
- | Gjatesia 20 m

Kodi 55-834

**CMIMI
5.500 Lek**



**KARRUKULL UJI
1/2**

- | Gjatesia tubit 15 m
- | Presioni 150 psi

Kodi WVZ1515

**CMIMI
6.900 Lek**



1
2
3
4
5
6
7
8
9
10

ZORRE UJI CLASSIC

- | Diametri 1/2"
- | Gjatesia 20 m
- | Presioni 22 bar

Kodi 18003-20

CMIMI 2.990 Lek

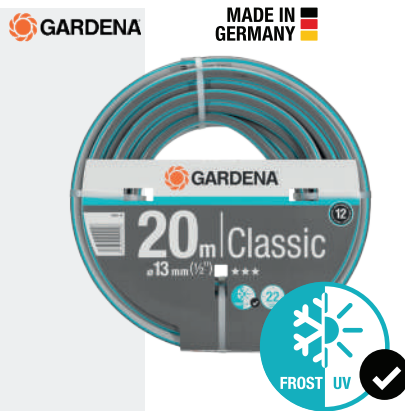

ZORRE UJI CLASSIC

- | Diametri 1/2"
- | Gjatesia 30 m
- | Presioni 22 bar

Kodi 18009-20

CMIMI 4.500 Lek



ZORRE UJI CLASSIC

- | Diametri 5/8"
- | Gjatesia 20 m
- | Presioni 22 bar

Kodi 18013-26

CMIMI 3.900 Lek



ZORRE UJI CLASSIC

- | Diametri 1/2"
- | Gjatesia 50 m
- | Presioni 22 bar

Kodi 18010-20

CMIMI 7.500 Lek



ZORRE UJI CLASSIC

- | Diametri 3/4"
- | Gjatesia 50 m
- | Presioni 22 bar

Kodi 18025-20

CMIMI 11.500 Lek



ZORRE UJI FLEX

- | Diametri 1/2"
- | Gjatesia 30 m
- | Presioni 25 bar

Kodi 18036-20

CMIMI 4.900 Lek



ZORRE UJI FLEX

- | Diametri 1/2"
- | Gjatesia 50 m
- | Presioni 25 bar

Kodi 18039-20

CMIMI 8.500 Lek

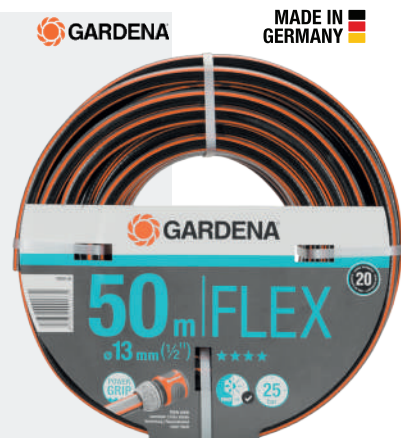

ZORRE UJI FLEX

- | Diametri 3/4"
- | Gjatesia 50 m
- | Presioni 25 bar

Kodi 18055-20

CMIMI 13.500 Lek



**30
YEARS
GUARANTEE**



MADE IN ITALY

fitt
TECHNOLOGY FLOW

Tube uji Jeans me 6 shtresa

Kodi	Diam.	m	Çmimi
76196.16625.59	1/2"	25 m	3.900
76196.16650.59	1/2"	50 m	7.500
76196.20625.59	5/8"	25 m	4.500
76196.20650.59	5/8"	50 m	8.500
76196.30625.59	3/4"	25 m	6.500
76196.30650.59	3/4"	50 m	12.500
76196.42925.59	1"	25 m	8.500
76196.42950.59	1"	50 m	15.900

**30
YEARS
GUARANTEE**



MADE IN ITALY

fitt
TECHNOLOGY FLOW

Tube uji NTS ORANGE i papërthyeshem me 6 shtresa

Kodi	Diam.	m	Çmimi
76199.16625.59	1/2"	25 m	3.900
76199.16650.59	1/2"	50 m	7.900
76199.30625.59	3/4"	25 m	5.900
76199.30650.59	3/4"	50 m	11.500

**15
YEARS
GUARANTEE**

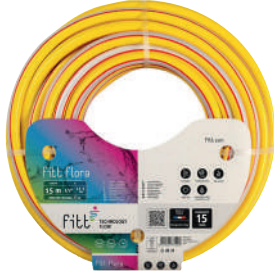

MADE IN ITALY

fitt
TECHNOLOGY FLOW

Tube uji Flora i papërthyeshem me 5 shtresa

Kodi	Diam.	m	Çmimi
77042.16625.59	1/2"	25 m	3.000
77042.16650.59	1/2"	50 m	5.900
77042.20625.59	5/8"	25 m	3.900
77042.20650.59	5/8"	50 m	7.500
77042.30625.59	3/4"	25 m	5.500
77042.30650.59	3/4"	50 m	9.900
77042.42925.59	1"	25 m	8.500
77042.42950.59	1"	50 m	14.900

**10
YEARS
GUARANTEE**



MADE IN ITALY

fitt
TECHNOLOGY FLOW

Tube uji Fitt Mint me 4 shtresa

Kodi	Diam.	m	Çmimi
71017.16625.59	1/2"	25 m	1.700
71017.16650.59	1/2"	50 m	3.500
71017.20625.59	5/8"	25 m	2.300
71017.20650.59	5/8"	50 m	3.900
71017.30625.59	3/4"	25 m	3.500
71017.42925.59	1"	25 m	5.900
71017.42950.59	1"	50 m	11.500

**5
YEARS
GUARANTEE**



MADE IN ITALY

fitt
TECHNOLOGY FLOW

Tube uji Mimosa me 3 shtresa

Kodi	Diam.	m	Çmimi
71300.16625.59	1/2"	25 m	1.900
71300.16650.59	1/2"	50 m	3.900
71300.20625.59	5/8"	25 m	2.500
71300.20650.59	5/8"	50 m	4.900
71300.30625.59	3/4"	25 m	3.690
71300.30650.59	3/4"	50 m	6.900
71300.42925.59	1"	25 m	5.900
71300.42950.59	1"	50 m	11.500

**5
YEARS
GUARANTEE**



MADE IN ITALY

fitt
TECHNOLOGY FLOW

Tube uji Idro Yellow me 3 shtresa

Kodi	Diam.	m	Çmimi
71021.16625.59	1/2"	25 m	990
71021.16650.59	1/2"	50 m	1.990
71021.20625.59	5/8"	25 m	1.290
71021.20650.59	5/8"	50 m	2.690
71021.30625.59	3/4"	25 m	1.990
71021.30650.59	3/4"	50 m	4.500
71021.42925.59	1"	25 m	3.900
71021.42950.59	1"	50 m	7.900

2
YEARS
GUARANTEE



MADE IN ITALY

fitb
TECHNOLOGY FLOW

Tub uji Idro Color me 2 shtresa

Kodi	Diam.	m	Çmimi
71039.42950.59	1"	50 m	8.900

25
bar



MADE IN GERMANY

Set Tub uji Flex + pistolete, adaptor, rakorderi dhe bashkuese

Kodi	Diam.	m	Çmimi
18034-20	1/2"	20 m	6.500

30
YEARS
GUARANTEE

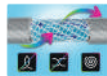

MADE IN ITALY

fitb
TECHNOLOGY FLOW

Kit NTS ORANGE i papërthyeshem me 6 shtresa + pistolete, bashkuese dhe adaptor

Kodi	Diam.	m	Çmimi
76199.16620.59	1/2"	20 m	4.500



GUARANTEE 30 YEARS
Designed in Italy
Made in Italy

MADE IN ITALY

fitb
TECHNOLOGY FLOW

Kit Tub uji Idro Color me 2 shtresa + pistolete dhe rakorderi

Kodi	Diam.	m	Çmimi
76525.20620.59000	5/8"	20 m	4.900



Set rakorderi dhe tub ATS-V i papërthyeshem me 5 shtresa

Kodi	Diam.	m	Çmimi
13-390	1/2"	20 m	6.500



Set rakorderi dhe tub ATS Green i papërthyeshem me 5 shtresa

Kodi	Diam.	m	Çmimi
15-109	1/2"	20 m	3.500



Set Tub uji Idro Green Ekonomik me 3 shtresa dhe rakorderi

Kodi	Diam.	m	Çmimi
10-100	1/2"	20 m	1.500
10-102	3/4"	20 m	2.900



Tub uji ATS-2 Hobby i paperthyeshem me 6 shtresa

Kodi	Diam.	m	Çmimi
16-200	1/2"	25 m	3.900
16-201	1/2"	50 m	6.900
16-221	3/4"	50 m	12.500



Tub uji ATS Green i paperthyeshem me 5 shtresa

Kodi	Diam.	m	Çmimi
15-100	1/2"	25 m	3.500
15-101	1/2"	50 m	6.500
15-120	3/4"	25 m	5.900
15-121	3/4"	25 m	9.900



Tub uji Idro Blue Basic me 3 shtresa

Kodi	Diam.	m	Çmimi
10-400	1/2"	20 m	1.750
10-401	1/2"	30 m	2.500
10-402	1/2"	50 m	3.500
10-422	3/4"	50 m	7.500



Tub uji Yellow me 4 shtresa

Kodi	Diam.	m	Çmimi
10-500	1/2"	20 m	1.350
10-501	1/2"	30 m	1.950
10-502	1/2"	50 m	2.990
10-522	3/4"	50 m	6.900



Tub uji Idro Green Ekonomik me 3 shtresa

Kodi	Diam.	m	Çmimi
10-005	1/2"	20 m	990
10-003	1/2"	30 m	1.990
10-023	3/4"	25 m	2.500
10-022	3/4"	50 m	3.500



Tub uji Color Elastic Eco Portokalli me 1 shtrese PVC super rezistente

Kodi	Diam.	m	Çmimi
MG10013	1/2"	25 m	1.800
MG10014	1/2"	50 m	3.500
MG10031	3/4"	50 m	5.900
MG10032	1"	50 m	8.500



Tub uji Color Elastic Standard Jeshile me 1 shtrese PVC super rezistente

Kodi	Diam.	m	Çmimi
MG10010	1/2"	25 m	1.900
MG10011	1/2"	50 m	3.900
MG10030	3/4"	50 m	6.900
MG10040	1"	50 m	9.500



Tub uji Idro Lili me 3 shtresa

Kodi	Diam.	m	Çmimi
MF30140	1/2"	25 m	1.900
MF30141	1/2"	50 m	3.500
MF30142	3/4"	50 m	6.500
MF30143	1"	50 m	8.900



Tub uji Doris me 3 shtresa

Kodi	Diam.	m	Çmimi
MF30010	1/2"	25 m	1.700
MF30011	1/2"	50 m	2.990
MF30030	3/4"	50 m	5.500
MF30040	1"	50 m	7.900



Tub uji Blue Line

Kodi	Diam.	m	Çmimi
MF30144	1/2"	50 m	5.500
MF30145	3/4"	50 m	9.500
MF30146	1"	50 m	12.500



Tub uji Termo Standart

Kodi	Diam.	m	Çmimi
MT20010	1/2"	50 m	3.500
MT20030	3/4"	50 m	5.900
MT20040	1"	50 m	7.900

AK Palaplast



Tub Thithes Spiral Jeshil

Kodi	Diam.	m	Çmimi
4076/1019	3/4" / 19 mm	50 m	6.500
4076/1025	1" / 25 mm	50 m	6.900
4076/1032	1 1/4" / 32 mm	50 m	11.500
4076/1038	1 1/2" / 38 mm	50 m	16.500

AK Palaplast



Tub Thithes Spiral Jeshil Heavy Duty

Kodi	Diam.	m	Çmimi
4076/2050	2" / 51 mm	50 m	24.500
4076/2075	3" / 76 mm	50 m	39.900
4076/2100	4" / 102 mm	50 m	59.900

AK Palaplast



Tub uji petashuk 6 ATM

Kodi	Diam.	m	Çmimi
4406/0652	2" / 53 mm	100 m	11.900
4406/0478	3" / 78 mm	100 m	17.900

VOREL



Tub uji petashuq 2 Bar

Kodi	Diam.	m	Çmimi
79983	2"	50 m	5.900
79984	3"	50 m	8.900

VOREL



Tub Pikimi Vadites Plastik

Kodi	Dia/Metrat	Çmimi
89373	16mm/30m	1.890

plahosan



Tub niveli

Kodi	Diam.	m	Çmimi
MH20020	8 mm	100 m	2.500
MH20030	10 mm	100 m	3.300

<p>18300-20</p> <p> MADE IN GERMANY</p>  <p>Çmimi 950</p> <p></p>	<p>18301-20</p> <p> MADE IN GERMANY</p>  <p>Çmimi 1.700</p> <p></p>	<p>18303-20</p> <p> MADE IN GERMANY</p>  <p>Çmimi 2.390</p> <p></p>
<p>Pistoletë vadijtje Koke plastike kunder goditjeve</p>	<p>Pistoletë vadijtje Classic Me 2 lloje sperkatje, bllokues doreze</p>	<p>Pistoletë vadijtje Comfort Me 3 lloje sperkatje, bllokues doreze</p>
<p>18305-20</p> <p> MADE IN GERMANY</p>  <p>Çmimi 3.500</p> <p></p>	<p>961-20</p> <p> MADE IN GERMANY</p>  <p>Çmimi 3.990</p>	<p>18311-20</p> <p> MADE IN GERMANY</p>  <p>Çmimi 2.200</p>
<p>Pistoletë vadijtje metalike Me 2 lloje sperkatje</p>	<p>Dush për ambiente te jashtme Lartësia totale: 207</p>	<p>Pistoletë me sprucim të imët Dorezë e gomuar</p>
<p>18313-20</p> <p> MADE IN GERMANY</p>  <p>Çmimi 3.200</p>	<p>18298-20</p> <p> MADE IN GERMANY</p>  <p>Çmimi 5.500</p>	<p>18330-20</p> <p> MADE IN GERMANY</p>  <p>Çmimi 3.000</p> <p></p>
<p>Pistoletë me 3 lloje sprucimesh Dorezë e gomuar, Bllokues doreze</p>	<p>Set vadijtje me pistoletë ujitje + rakorderi, rakorderi e shpejtë, adaptor</p>	<p>Pistoletë vadijtje me stekë Me sprucim të imët, Bllokues doreze</p>
<p>18312-33</p> <p> MADE IN GERMANY</p>  <p>Çmimi 1.890</p>	<p>18299-34</p> <p> MADE IN GERMANY</p>  <p>Çmimi 2.390</p>	<p>18291-20</p> <p> MADE IN GERMANY</p>  <p>Çmimi 2.390</p> <p></p>
<p>Set vadijtje Pistoletë ujitje dhe rakorderi e shpejtë 1/2"</p>	<p>Set vadijtje Pistoletë ujitje dhe set rakorderi e shpejtë</p>	<p>Set vadijtje me 2 rakorderi 1/2", 5/8" Adaptor rubineti G 3/4 dhe G1.</p>

<p>18215-50</p> <p>GARDENA MADE IN GERMANY</p>  <p>Çmimi 690</p> <p>Rakorderi e shpejte</p> <p>1/2"</p>	<p>18216-20</p> <p>GARDENA MADE IN GERMANY</p>  <p>Çmimi 850</p> <p>Rakorderi e shpejte</p> <p>3/4"</p>	<p>18213-20</p> <p>GARDENA MADE IN GERMANY</p>  <p>Çmimi 790</p> <p>Rakorderi e shpejte</p> <p>Me bllokues uji 1/2"</p>
<p>18214-20</p> <p>GARDENA MADE IN GERMANY</p>  <p>Çmimi 990</p> <p>Rakorderi e shpejte</p> <p>Me bllokues uji 3/4"</p>	<p>18232-20</p> <p>GARDENA MADE IN GERMANY</p>  <p>Çmimi 550</p> <p>Bashkuese tubi</p> <p>13 mm (1/2") - 15 mm (5/8")</p>	<p>18233-20</p> <p>GARDENA MADE IN GERMANY</p>  <p>Çmimi 650</p> <p>Bashkuese tubi</p> <p>3/4"</p>
<p>18220-20</p> <p>GARDENA MADE IN GERMANY</p>  <p>Çmimi 330</p> <p>Adaptor rubineti</p> <p>1/2"</p>	<p>18221-50</p> <p>GARDENA MADE IN GERMANY</p>  <p>Çmimi 370</p> <p>Adaptor rubineti</p> <p>3/4"</p>	<p>18222-50</p> <p>GARDENA MADE IN GERMANY</p>  <p>Çmimi 390</p> <p>Adaptor rubineti</p> <p>G1"</p>
<p>2921-20</p> <p>GARDENA MADE IN GERMANY</p>  <p>Çmimi 390</p> <p>Adaptor rubineti</p> <p>Mashkull 3/4"</p>	<p>2931-20</p> <p>GARDENA MADE IN GERMANY</p>  <p>Çmimi 390</p> <p>Bashkuese tubi</p> <p>Per 2 lidhje</p>	<p>5552-20</p> <p>GARDENA MADE IN GERMANY</p>  <p>Çmimi 3.500</p> <p>Doreze e pershkueshme</p> <p>Nga uji 90 cm</p>

8201-29



MADE IN GERMANY



Çmimi
2.890

Vadites i fshehur

T100 / 50-100 m²

8203-29



MADE IN GERMANY



Çmimi
4.500

Vadites i fshehur

T200 / 80-200 m²

8205-29



MADE IN GERMANY



Çmimi
4.900

Vadites i fshehur

T380 / 380 m²

8133-20



MADE IN GERMANY



Çmimi
2.900

Automat Aqua Contour

Per sip.380 m²

13135-34



MADE IN GERMANY



Çmimi
6.900

Set ftohjeje me uje

Per ambiente të jashtme

1210-20



MADE IN GERMANY



Çmimi
1.100

Sherpndares me dy dalje

3/4" dhe 1"

2065-20



MADE IN GERMANY



Çmimi
3.990

Vadites me bazament

Tango / 310 m²

7819-20



MADE IN GERMANY



Çmimi
990

Hedhes uji ne forme

Shkume 1

7884-20



MADE IN GERMANY



Çmimi
200

Tab teleskop

Per kokat e shatervaneve G3/4

1890-29



MADE IN GERMANY



Çmimi
7.900

Ore kompiuterike

Per kontrollin e vaditjes

52-090



Çmimi
1.900

Ore per vaditje IDEAL

Me regjistrim mekanik deri 120min 3/4"-1"

WQC5534



























Çmimi
3.500













Ore vaditje dixhitale

Prurja 50 Lt/min, 4 bar

<p>53-320</p> <p>cellfast</p>  <p>Çmimi 1.650</p>	<p>53-340</p> <p>cellfast</p>  <p>Çmimi 2.390</p>	<p>53-530</p> <p>cellfast</p>  <p>Çmimi 2.990</p>
<p>Pistoletë vadijtje ERGO</p> <p>Pistoletë ujitje dhe rakorderi e shpejtë</p>	<p>Pistoletë ujitje koke dushi</p> <p>me 4 sprucime ERGO</p>	<p>Pistoletë vadijtje ERGO</p> <p>Me 4 sprucime dhe rakorderi 1/2", 3/4", 1"</p>
<p>50-700</p> <p>cellfast</p>  <p>Çmimi 350</p>	<p>50-740</p> <p>cellfast</p>  <p>Çmimi 1.100</p>	<p>50-750</p> <p>cellfast</p>  <p>Çmimi 1.390</p>
<p>Pistoletë vadijtje e drejte</p> <p>1/2" me 2 funksione IDEAL</p>	<p>Pistoletë vadijtje multifunksionale</p> <p>1/2" - 5/8" VARIANT IDEAL</p>	<p>Pistoletë vadijtje multifunksionale</p> <p>Koke dushi me rakorderi 1/2"-5/8" IDEAL</p>
<p>50-737</p> <p>cellfast</p>  <p>Çmimi 650</p>	<p>50-738</p> <p>cellfast</p>  <p>Çmimi 820</p>	<p>50-760</p> <p>cellfast</p>  <p>Çmimi 1.100</p>
<p>Pistoletë vadijtje</p> <p>1/2" me 2 funksione HYDRON</p>	<p>Pistoletë vadijtje koke dushi</p> <p>Me 6 funksione HYDRON</p>	<p>Pistoletë vadijtje koke dushi</p> <p>Me rakorderi 1/2" - 5/8" HYDRON</p>
<p>52-320</p> <p>cellfast</p>  <p>Çmimi 1.490</p>	<p>52-321</p> <p>cellfast</p>  <p>Çmimi 1.250</p>	<p>52-340</p> <p>cellfast</p>  <p>Çmimi 1.450</p>
<p>Pistoletë vadijtje koke dushi</p> <p>Me 7 funksione BASIC</p>	<p>Pistoletë vadijtje</p> <p>Me 3 funksione BASIC</p>	<p>Steke vadijtje koke dushi</p> <p>Me 10 funksione BASIC</p>

<p>50-500</p>   <p>Çmimi 590</p>	<p>50-505</p>   <p>Çmimi 650</p>	<p>50-630</p>   <p>Çmimi 250</p>
<p>Set pistolette vaditje</p> <p>Me rakorderi 1/2" BASIC</p>	<p>Set pistolette vaditje</p> <p>Me rakorderi 3/4" BASIC</p>	<p>Rakorderi e shpejte</p> <p>1/2" - 5/8" IDEAL</p>
<p>51-130H</p>   <p>Çmimi 170</p>	<p>50-635</p>   <p>Çmimi 290</p>	<p>51-135H</p>   <p>Çmimi 190</p>
<p>Rakorderi e shpejte</p> <p>1/2"-5/8" BASIC</p>	<p>Rakorderi e shpejte</p> <p>3/4" IDEAL</p>	<p>Rakorderi e shpejte</p> <p>3/4" BASIC</p>
<p>51-133</p>   <p>Çmimi 160</p>	<p>50-600</p>   <p>Çmimi 195</p>	<p>50-605</p>   <p>Çmimi 235</p>
<p>Rakorderi e shpejte</p> <p>Me valvul 3/4" BASIC</p>	<p>Bashkuese tubi</p> <p>1/2" IDEAL</p>	<p>Bashkuese tubi</p> <p>3/4" IDEAL</p>
<p>50-610</p>   <p>Çmimi 235</p>	<p>50-640</p>   <p>Çmimi 165</p>	<p>51-100H</p>   <p>Çmimi 135</p>
<p>Bashkuese tubi</p> <p>Me reduktim 3/4" - 1/2" IDEAL</p>	<p>Bashkuese tubi</p> <p>Me 2 dalje IDEAL</p>	<p>Bashkuese tubi</p> <p>1/2" BASIC</p>

1
2
3
4
5
6
7
8
9
10

<p>51-105H</p> <p>cellfast</p>  <p>Çmimi 155</p> <p>Bashkuese tubi</p> <p>3/4" BASIC</p>	<p>51-110H</p> <p>cellfast</p>  <p>Çmimi 155</p> <p>Bashkuese tubi</p> <p>Me reduktim 3-4" - 1/2" BASIC</p>	<p>50-650</p> <p>cellfast</p>  <p>Çmimi 150</p> <p>Adaptor rubineti</p> <p>Femer 1/2" IDEAL</p>
<p>50-652</p> <p>cellfast</p>  <p>Çmimi 230</p> <p>Adaptor rubineti</p> <p>Femer 1/2"-3/4" IDEAL</p>	<p>50-655</p> <p>cellfast</p>  <p>Çmimi 160</p> <p>Adaptor rubineti</p> <p>Femer 3/4" IDEAL</p>	<p>50-657</p> <p>cellfast</p>  <p>Çmimi 290</p> <p>Adaptor rubineti</p> <p>Femer 3/4"-1" IDEAL</p>
<p>50-660</p> <p>cellfast</p>  <p>Çmimi 190</p> <p>Adaptor rubineti</p> <p>Femer 1" IDEAL</p>	<p>50-665</p> <p>cellfast</p>  <p>Çmimi 150</p> <p>Adaptor rubineti</p> <p>Mashkull 1/2" IDEAL</p>	<p>50-670</p> <p>cellfast</p>  <p>Çmimi 160</p> <p>Adaptor rubineti</p> <p>Mashkull 3/4" IDEAL</p>
<p>51-220H</p> <p>cellfast</p>  <p>Çmimi 110</p> <p>Adaptor rubineti</p> <p>Femer 1" BASIC</p>	<p>51-210H</p> <p>cellfast</p>  <p>Çmimi 90</p> <p>Adaptor rubineti</p> <p>Femer 1/2" BASIC</p>	<p>51-215H</p> <p>cellfast</p>  <p>Çmimi 100</p> <p>Adaptor rubineti</p> <p>Femer 3/4" BASIC</p>

52-220



Çmimi
790

Rubinet dysh

Per ndarjen e ujit 3/4"-1" IDEAL

52-257



Çmimi
420

Adaptor rubineti

Me filter per lavazhe IDEAL

52-304



Çmimi
1.250

Sperkates metalik

350 m² BASIC

52-405



Çmimi
850

Sperkates plastik

350 m² ECONOMIC

52-305



Çmimi
1.850

Sperkates me oshilim

250 - 300 m² BASIC

08241-20



Çmimi
1.190

Vadites i fshehur

SD30 / 30m²

1569-29



Çmimi
1.290

Vadites i fshehur

S80 / 80 m²

89162



Çmimi
490

Vadites i fshehur

1/2" F , 25-360grade 8 m

89163



Çmimi
490

Vadites i fshehur

1/2" F , 25-360grade 10 m

89164



Çmimi
690

Vadites i fshehur

1/2" F , 25-360grade 15 m

Pusete plastike per sistem vaditje



89109











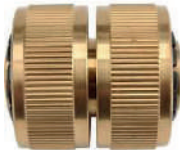





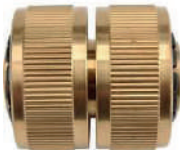







Çmimi
490

Adaptor rubineti bronzi

3/4" & 1"

Kodi	Pershkrimi	Çmimi
88780	10" e rrumbullaket	1.290
88783	12" katrore	3.500
88784	14" katrore	3.990

<p>89105</p>   <p>Çmimi 790</p>	<p>89108</p>   <p>Çmimi 450</p>	<p>89106</p>   <p>Çmimi 290</p>
<p>Bashkuese bronzi 3/4"</p>	<p>Adaptor bronzi per tub 1/2" & 3/4"</p>	<p>Adaptor rubineti Per tub 3/4"</p>
<p>89104</p>   <p>Çmimi 550</p>	<p>89100</p>   <p>Çmimi 590</p>	<p>89222</p>   <p>Çmimi 100</p>
<p>Bashkuese bronzi 1/2"</p>	<p>Rakoderi e shpejte Bronzi 1/2"</p>	<p>Rakoderi e shpejte Plastike 1/2" me varje</p>
<p>89224</p>   <p>Çmimi 120</p>	<p>89225</p>   <p>Çmimi 80</p>	<p>89227</p>   <p>Çmimi 100</p>
<p>Rakoderi e shpejte Plastike 3/4" me varje</p>	<p>Rakoderi e shpejte 1/2" me bllokues uji</p>	<p>Rakoderi e shpejte 3/4" me bllokues uji</p>
<p>89233</p>   <p>Çmimi 120</p>	<p>89214</p>   <p>Çmimi 490</p>	<p>89211</p>   <p>Çmimi 550</p>
<p>Rakoderi reduktuese plastike 3/4" & 1/2"</p>	<p>Pistoletë uji plastike Me 3 funksione</p>	<p>Pistoletë uji me koke dushi Me 8 funksione</p>

89242



Çmimi
80

Adaptor rubineti plastik

3/4" & 1/2"F me varje

89203



Çmimi
350

Set me 4 rakorderi plastike

3/4" & 1" dhe pistolette vaditje

89204



Çmimi
290

Set me 4 rakorderi plastike

1/2" & 3/4"

89252



Çmimi
100

Adaptor rubineti plastik

1" & 3/4"F me varje

89259



Çmimi
650

Sperkates metalik

24m 45-360grade

89272



Çmimi
290

Sperkates plastik

1/2" 360 grade 14m

89261



Çmimi
350

Sperkates plastik

1/2" 45-360 grade 24m

GH9040-D



Çmimi
100

Adaptor me filetimit

Mashkull 3/4"

WQC2E33



Çmimi
250

Set me 3 rakorderi

1/2"

HPHM0201



Çmimi
120

Rakorderi e shpejte

1/2"

HHCS01122



Çmimi
140

Rakorderi e shpejte

1/2"













HHCS01342



Çmimi
100

Rakorderi e shpejte

3/4"

<p>HHC1202</p> <p>ingco</p>  <p>Çmimi 270</p>	<p>HHC1201</p> <p>ingco</p>  <p>Çmimi 170</p>	<p>HHCS03122</p> <p>ingco</p>  <p>Çmimi 230</p>
<p>Bashkuese tubi uji me 2 dalje</p> <p>Dalja e tubit: 1" - 3/4" me mbylles manual</p> <p>HHCS05122</p> <p>ingco</p>	<p>Rubinet dysh per ndarjen e ujit</p> <p>Dalja e tubit: 1/2"</p> <p>HPS13601</p> <p>ingco</p>	<p>Set me 3 rakorderi</p> <p>Rakorderi me bllokues uji 1/2"</p> <p>Rakorderi e shpejte 1/2" + adaptor 3/4"</p> <p>GH9242</p> <p>NAKAYAMA</p>
 <p>Çmimi 350</p>	 <p>Çmimi 990</p>	 <p>Çmimi 390</p>
<p>Set me 5 rakorderi me pistolette ujitje</p> <p>Rakorderi me bllokues uji 1/2" Rakorderi e shpejte 1/2" + adaptor 3/4" & 1/2"</p> <p>HPS23602</p> <p>ingco</p>	<p>Vadites siperfaqesor</p> <p>Me funksion 360°</p> <p>HPS0402</p> <p>ingco</p>	<p>Mbajtese plastike murale</p> <p>Per tuba uji</p> <p>55-260</p> <p>cellfast</p>
 <p>Çmimi 450</p>	<p>Fits hose size up to 1/2"x40m</p>  <p>Çmimi 1.550</p>	 <p>Çmimi 4.990</p>
<p>Vadites me 3 krahe</p> <p>Permasa 16.5 x 14 x 8</p> <p>HWSG032</p> <p>ingco</p>	<p>Karrukull plastike per tub uji</p> <p>1/2"*40m (montohet edhe ne mur)</p> <p>HWSG092</p> <p>ingco</p>	<p>Karroce uji metalike ALUPLUS</p> <p>Diametri 1/2", Per tub 60m</p> <p>HWW092</p> <p>ingco</p>
 <p>Çmimi 350</p>	 <p>Çmimi 450</p>	 <p>Çmimi 250</p>
<p>Pistolette vaditje plastike</p> <p>Permasa 250 mm</p>	<p>Pistolette vaditje plastike</p> <p>Me koke dushi 250 mm</p>	<p>Steke me koke dushi</p> <p>Me 9 lloje sperkatjesh</p>

3091



Pikues Lotues i rregullueshem ne tub

Kodi	Permase	Paketimi	Çmimi
3091/0000	I kuq 0-70L/H	50 cope	15
3091/0007	I zi 0-70L/H	50 cope	15
3091/0070	I verdhe 0-70L/H	50 cope	15

3091



Pikues Lotues i rregullueshem ne tub

Kodi	Permase	Paketimi	Çmimi
3091/0100	jeshil 0-100L/H	40 cope	16

3093



Pikues Lotues i rregullueshem ne tub

Kodi	Permase	Paketimi	Çmimi
3093/0150	I zi 0-150L/H	35 cope	18

3195



Pikues Lotues i rregullueshem ne tub

Kodi	Permase	Paketimi	Çmimi
3195/1070	I kuq me kunje 0-70L/H	30 cope	45
3195/2070	I zi me kunje 0-70L/H	30 cope	45

3090



Pikues Direkt per tub

Kodi	Permase	Paketimi	Çmimi
3090/0004	Jeshil 2L/H, 12-32 mm	50 cope	35
3090/0006	I kuq 6L/H, 12-32 mm	50 cope	35
3090/0008	Blu 8L/H, 12-32 mm	50 cope	35

3088



Mikropikues Direkt Hydra per tub

Kodi	Permase	Paketimi	Çmimi
3088/0002	I kuq 2L/H, 16-32 mm	50 cope	25
3088/0004	Jeshil 2L/H, 16-32 mm	50 cope	25

3114



Shigjete pikimi e harkuar 30 Grade

Kodi	Permase	Paketimi	Çmimi
3114/3015	E zeze 2L/H	40 cope	20
3114/3040	Kafe 2L/H	40 cope	20

3113



Shigjete suportuese e harkuar 30 grade

Kodi	Permasa	Paketimi	Çmimi
3113/0003	Jeshile 3L/H	40 cope	20
3113/0004	Blu 4L/H	40 cope	20
3113/0005	E kuqe 5L/H	40 cope	20

3005



Mikrosperkates Delta

Kodi	Permasa	Paketimi	Çmimi
3005/0120	I kuq 120L/H / 10 m	20 cope	69
3005/0160	Kaf 160L/H / 10.5 m	20 cope	69
3005/0200	I verdhe 120L/H / 11 m	20 cope	69

3006



Mikrosperkates 2000

Kodi	Permasa	Paketimi	Çmimi
3006/0120	I kuq 120L/H / 10 m	20 cope	75
3006/0160	Kaf 160L/H / 10.5 m	20 cope	75
3006/0200	I verdhe 120L/H / 11 m	20 cope	75

3003



Mikrosperkates

Kodi	Permasa	Paketimi	Çmimi
3003/0090	Jeshil 90L/H / 7.5 m	40 cope	39
3003/0120	I Kuq 120L/H / 8 m	40 cope	39
3003/0160	Kaf 160L/H / 8.5 m	40 cope	39
3003/0200	I verdhe 200L/H / 9 m	40 cope	39
3003/0300	Ulliri 300 L/H / 9.5 m	40 cope	39

3002



Mikrosperkates

Kodi	Permasa	Paketimi	Çmimi
3002/0090	Jeshil 90L/H / 7.5 m	40 cope	35
3002/0120	I Kuq 120L/H / 8 m	40 cope	35
3002/0160	Kaf 160L/H / 8.5 m	40 cope	35
3002/0200	I verdhe 200L/H / 9 m	40 cope	35

3013



Mikrosperkates

Kodi	Permasa	Paketimi	Çmimi
3013/0040	Portokalli 40L/H / 2.5 m	40 cope	49
3013/0070	I Zi 70L/H / 3 m	40 cope	49
3013/0120	I Kuq 120L/H / 4.5 m	40 cope	49
3013/0200	I verdhe 200L/H / 5 m	40 cope	49

3023



Mikrosperkates 90 grade

Kodi	Permasa	Paketimi	Çmimi
3023/0070	I Zi 70L/H / 3.5 m	40 cope	69
3023/0090	Jeshil 120L/H / 3.5 m	40 cope	69
3023/0120	I Kuq 120L/H / 4 m	40 cope	69

3024



Mikrosperkates 180 grade

Kodi	Permasa	Paketimi	Çmimi
3024/0090	Jeshil 90L/H / 3.5 m	40 cope	69
3024/0105	Blu 105L/H / 4 m	40 cope	69
3024/0120	I Kuq 120L/H / 4 m	40 cope	69

3025



Mikrosperkates 270 grade

Kodi	Permasa	Paketimi	Çmimi
3025/0090	Jeshil 90L/H / 3.5 m	40 cope	69
3025/0105	Blu 105L/H / 4 m	40 cope	69
3025/0120	I Kuq 120L/H / 4 m	40 cope	69

3017



Mini-jet sperkates 180 grade

Kodi	Permasa	Paketimi	Çmimi
3017/0060	Gri 60L/H / 2.5 m	50 cope	12
3017/0090	Jeshil 90L/H / 2.5 m	50 cope	12
3017/0120	I Kuq 120L/H / 2.5 m	50 cope	12

3018



Mini-jet sperkates 360 grade

Kodi	Permasa	Paketimi	Çmimi
3018/0060	Gri 60L/H / 2..5 m	50 cope	12
3018/0090	Jeshil 60L/H / 2.5 m	50 cope	12
3018/0120	I Kuq 60L/H / 2.5 m	50 cope	12

3033



Mjegullues 6 mm

Kodi	Permasa	Paketimi	Çmimi
3033/1006	1X6,2lt/h, F/ 6 mm	10 cope	290
3033/4006	4X6,2lt/h, F/ 6 mm	10 cope	750
3033/5006	5X6,2lt/h, F/ 6 mm	10 cope	890

3051



Kunje per sistemin e pikimit

Kodi	Permasa	Ngjyra	Çmimi
3051/1840	8mm x 40 cm	I Kuq	100
3051/1250	12mm x 40 cm	I Zi	190

3054



Adaptor per sistem pikimi

Kodi	Permasa	Paketimi	Çmimi
3054/1006	I Kuq 6 mm	100 cope	12
3054/1008	I Zi 8 mm	100 cope	19

3112



Kunje toke

Kodi	Permasa	Paketimi	Çmimi
3112/1620	16 - 20 mm	100 cope	35

3068



Pistolette shpuese manuale

Kodi	Permasa	Paketimi	Çmimi
3068/1003	3 mm	Jeshile	590
3068/1004	4 mm	Blu	590
3068/1006	6 mm	E kuqe	590



SHKALLË ALUMINI
KARROCA, RAFTE METALIKE
KOSHA, LITARË DHE ZINXHIRË

SHKALLE ALUMINI PROFESIONALE



MADE IN GERMANY



Certificate EN 131 Norm

Kodi		Çmimi
000712	CORDA 1X3	4.500
000705	CORDA 1X4	5.500
000729	CORDA 1X5	6.500
000736	CORDA 1X6	7.500
000743	CORDA 1X7	9.900



SHKALLE ALUMINI TEKE



MADE IN GERMANY



Certificate EN 131 Norm

Kodi		Çmimi
010087	CORDA 1X8	5.900
010100	CORDA 1X10	7.500
030115	CORDA 1X11	8.500
030122	CORDA 1X12	9.900



SHKALLE ALUMINI ME KOMBINIM



MADE IN GERMANY



Certificate
EN 131
Norm

Kodi		Çmimi
030283	CORDA 2X8	14.500
030221	CORDA 2X11	17.900
033376	CORDA 3X7	17.900
033390	CORDA 3X9	22.500
030429	CORDA 3X11	29.900
085214	me kombinim dhe platforme CORDA 4X3	26.900



SHKALLE ALUMINI



MADE IN GERMANY



Certificate
EN 131
Norm

Kodi		Çmimi
120328	DOPPLO 2X3	6.900
120335	DOPPLO 2X4	9.900
120359	DOPPLO 2X6	14.500



SKELE ALUMINI / ME 1 ZGJERIM / ME 2 ZGJERIME

MADE IN GERMANY

ClimTec
System

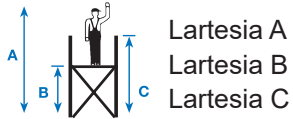

Lartesia A
Lartesia B
Lartesia C

	Baza	Baza + shtesa 1	Baza + shtesa 1&2
Permasa e bazes	1.92 x 1.42	1.92 x 1.42	1.92 x 1.42
Permasa e platformes	1.50 x 0.60	1.50 x 0.60	1.50 x 0.60
Gjersia	1.5	1.5	1.5
Thellesia	0.65	0.65	0.65
Pesha	31	54	84



KODI 714039

Mbeshtetese
Clim Tec

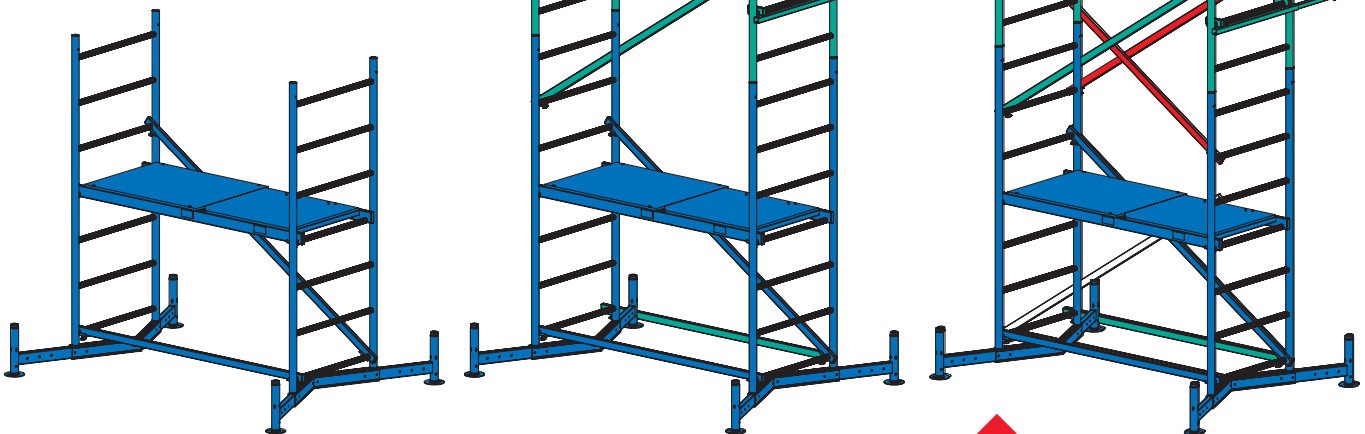

Kodi. 710147

Kodi. 710123

Kodi. 710116

■ Skele Alumini baze Clim Tec	59.000
■ Skele Alumini me nje zgjerim Clim Tec	69.000
■ Skele Alumini me dy zgjerime Clim Tec	79.000

SET ME RROTA (4COPE)

MONTO

Rrota per skelë
Permasa 125mm CT



KODI 714169

21.500



MADE IN GERMANY

SKELE ALUMINI STABILO



Ngarkesa maksimale 200 kg/m² (grupi i platformës 3) në përputhje me DIN EN 1004. Trari i fortë me bazë çeliku rrit stabilitetin. Rrotat e rregullueshme në lartësi (Ø 150 mm) lejojnë që produkti të përdoret në sipërfaqe të pabarabarta. Platformat varen lehtësisht midis shufrave diagonale (hapi - 25 cm). Operacionet intensive të punës së rirregullimit dhe çmontimit eliminohen. Për lartësitë e punës së produktit prej 7,40 m ose më shumë, mbështetësit e qosheve përfshihen në paketën e dorëzimit.

Gjatësia e seksionit: 2,00 dhe 2,50 m

Gjerësia e seksionit: 0,75 m



KODI 741332

375.000

MADE IN GERMANY

- 1
- 2
- 3
- 4
- 5
- 6
- 7
- 8
- 9
- 10

PUSHTUES ALUMINI I LEVIZSHEM STABILO / 1X8 -110



Gjatësia maksimale	3 m
Numri i shkallëve	8
Lartësia e punës	3.9 m
Lartësia e platformës	1.9 m
Dimensionet e platformës	60x70 cm
Pesha	63.60 kg

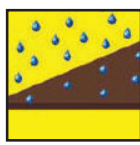

KODI 820686

99.500

SHKALLE ALUMINI ME 2 ELEMENTE CORDA

KODI	916129	(ca. m)	MADE IN GERMANY
ca. 48,0 kg			
EN 1004 / 150 kg/m ²			
69.900			

SKELE ALUMINI CORDA 4 MULTIFUNKSIONALE

KODI	916341	MADE IN GERMANY
65.900		

SKELE ALUMINI E PALOSESHME CORDAWH

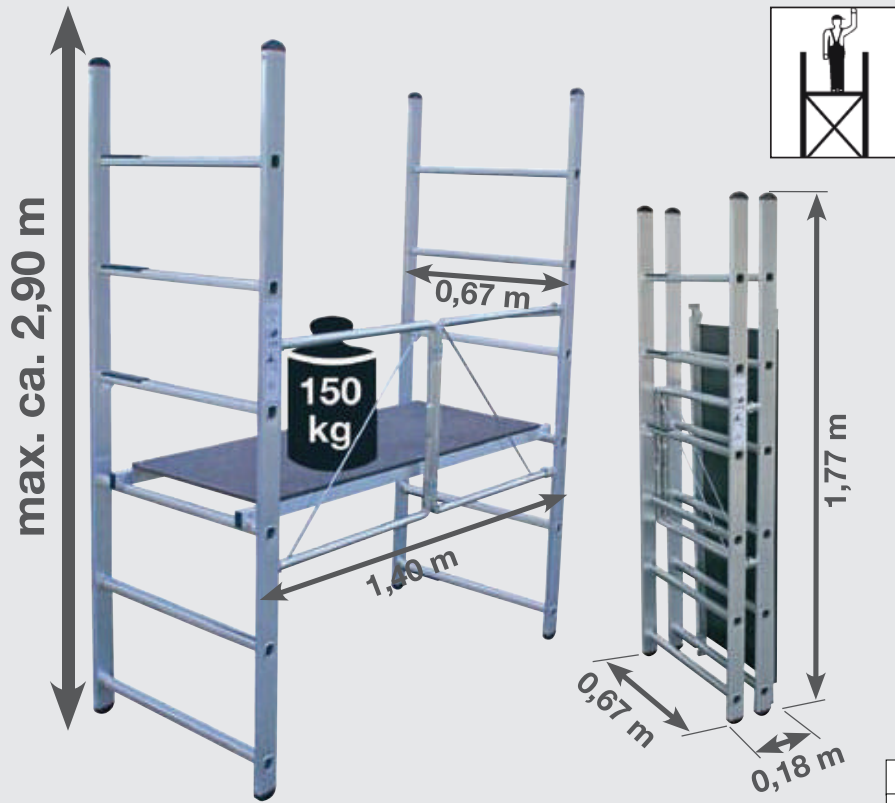

MADE IN GERMANY

KODI 916198
29.900



SKELE ALUMINI ME RROTA CORDA WH

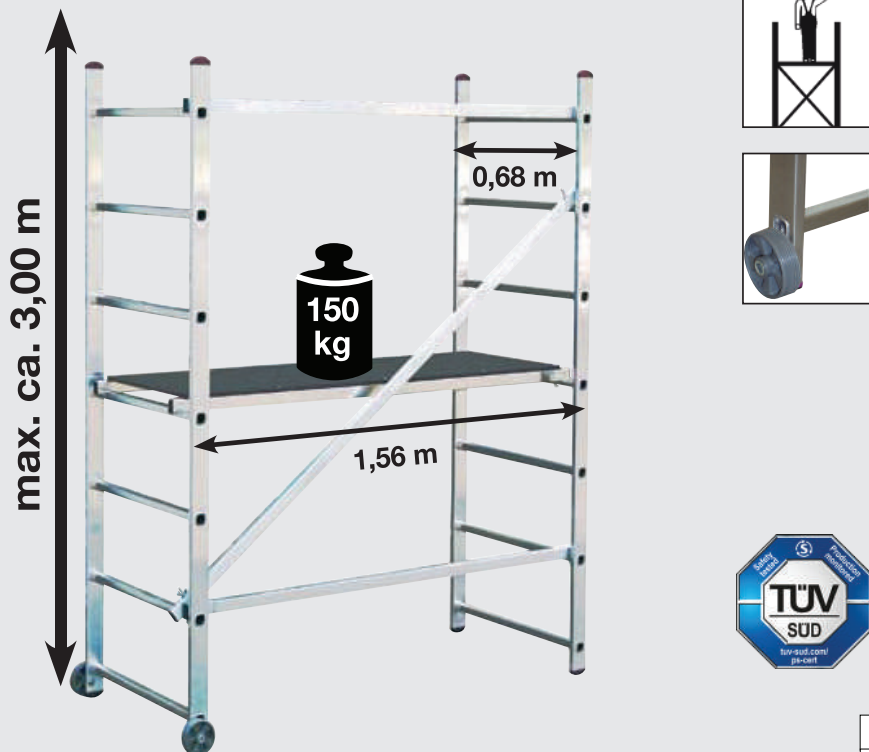

MADE IN GERMANY

KODI 916174
26.900



SHKALLE ALUMINI FAMILJARE

FORCE
 MACHINERY - TOOLS

- Sistemi i mbylljes së sigurisë me mekanizem metalike.
- Palosja praktike.
- Gati për t'u përdorur në paketim të vetëm elegant.
- Këmbë plastike prej materiali kundër rrëshqitjes.
- Hapat e projektuar special për të shmangur rrëshqitjen.

Kodi		Çmimi
FLH103	me 3 shkelle	2.990
FLH104	me 4 shkelle	3.500
FLH105	me 5 shkelle	3.900
FLH106	me 6 shkelle	4.900
FLH107	me 7 shkelle	5.500



SHKALLE ALUMINI DOPPLO

FORCE
 MACHINERY - TOOLS

- Sistemi i mbylljes së sigurisë me mekanizem metalike
- Palosja praktike.
- Hapat e projektuar special për të shmangur rrëshqitjen.



Kodi		Çmimi
FLH502	2x2	2.500
FLH503	3x3	3.300
FLH504	4x4	4.300



SHKALLE ALUMINI TELESKOPIKE

FORCE
 MACHINERY - TOOLS

- Ky sistem i shkallëve të nivelit profesional përmban një dizajn te konvertueshëm që e lejon atë të përdoret deri në 33 hapje te ndryshme.
- Alumini dhe mentesha me dy kunjë ofrojnë stabilitet, ndërsa mekanizmi i hapjes e bën të lehtë rregullimin e lartësisë.
- Peshembajtja 150 kg .
- E pershtatshme per perdorim ne industri dhe shtepi.



Kodi		Çmimi
FLM403	4x3	9.900
FLM404	4x4	11.900
FLM405	4x5	13.500



SHKALLE ALUMINI INDUSTRIALE DYSHE

- Mentasha mbyllëse e patentuar me një siguresë që mund të hapet me një dorë për përdorim të shpejtë dhe të rehatshëm.
- Stabilizues i gjerë për një stabilitet maksimal.
- Profili anësor të aluminit të përforcuar.
- Shkallët e profilizuara nga të gjitha anët 30 mm të thella 60 mm për një siguri maksimale
- Lidhje të gjata shina anësore.
- E palosshme për ruajtje që kursen hapësirë.
- Tapa rezistente ndaj rrëshqitjes.
- Ripa te forte per qundrueshmeri ne lartesi.



Kodi		Çmimi
FLE212	2x12 6.2m	13.500
FLE214	2x14 7.3m	14.900

SHKALLE ALUMINI INDUSTRIALE TRESHE

- Mentasha mbyllëse e patentuar me një siguresë që mund të hapet me një dorë për përdorim të shpejtë dhe të rehatshëm.
- Stabilizues i gjerë për një stabilitet maksimal.
- Profili anësor të aluminit të përforcuar.
- Shkallët e profilizuara nga të gjitha anët 30 mm të thella 60 mm për një siguri maksimale
- Lidhje të gjata shina anësore.
- E palosshme për ruajtje që kursen hapësirë.
- Tapa rezistente ndaj rrëshqitjes.
- Ripa te forte per qundrueshmeri ne lartesi.



Kodi		Çmimi
FLE312	3x12 8.5m	19.900
FLE314	3x14 10m	23.900

SHKALLE ALUMINI MULTIFUNKSIONALE

- Dimensione kompakte të palosura për transport dhe ruajtje të lehtë.
- Sistemi i thjeshtë i menteshave me klik.
- Shirita për me shume stabilitet.
- I përshtatshëm për një shumëllojshmëri të gjerë përdorimesh.
- Peshembajtja 150 kg .
- E përshtatshme per përdorim ne industri dhe shtëpi.



Kodi		Çmimi
FLM103	4x3	9.900
FLM104	4x4	11.900

SHKALLE ALUMINI DYSHE ME MEKANIZEM

FORCE
 MACHINERY - TOOLS

- Mentasha mbyllëse e patentuar me një siguresë që mund të hapet me një dorë për përdorim të shpejtë dhe të rehatshëm.
- Stabilizues i gjerë për një stabilitet maksimal.
- Profili anësor të aluminit të përforcuar.
- Shkallët e profilizuara nga të gjitha anët 30 mm të thella për një siguri maksimale
- Lidhje të gjata shina anësore.
- E palosshme për ruajtje që kursen hapësirë.
- Tapa rezistente ndaj rrëshqitjes.



Kodi		Çmimi
FLM308	2x8	9.900
FLM310	2x10	11.900

SHKALLE FAMILJARE METALIKE (TE KUQE)

FORCE
 MACHINERY - TOOLS

- Sistemi i mbylljes së sigurisë me mekanizem metalike
- Palosja praktike.
- Gati për t'u përdorur në paketim të vetëm elegant.
- Këmbë plastike prej materiali kundër rrëshqitjes.
- Hapat e projektuar special për të shmangur rrëshqitjen.
- Dekorative për përdorim në shtëpi dhe industri.



Kodi		Çmimi
FLS202	me 2 shkelje	2.500
FLS203	me 3 shkelje	3.500
FLS204	me 4 shkelje	3.900
FLS205	me 5 shkelje	4.500
FLS206	me 6 shkelje	4.900

SHKALLE HEKURI

- Sistemi i mbylljes së sigurisë me mekanizem metalike
- Palosja praktike.
- Këmbë plastike prej materiali kundër rrëshqitjes.
- Hapat e projektuar special për të shmangur rrëshqitjen.

Kodi		Çmimi
SHKH4X3	4x3	5.900
SHKH4X4	4x4	6.500
SHKH4X5	4x5	6.900
SHKH5X5	5x5	7.500
MK	Mekanizem / Ingranazhet per shkalle hekuri	1.250



SHKALLE DRURI A

Saraylı



Kodi		Çmimi
1404	Me 4 shkelje	6.500
1405	Me 5 shkelje	6.900

SHKALLE METALIKE FAMILJARE



- Sistemi i mbylljes së sigurisë me mekanizem metalike
- Palosja praktike.
- Gati për t'u përdorur në paketim të vetëm elegant.
- Këmbë plastike prej materiali kundër rrëshqitjes.
- Hapat e projektuar special për të shmangur rrëshqitjen.
- Dekorative per perdorim në shtëpi dhe industri.

Kodi		Çmimi
HLAD09021	me 2 shkelje	2.990
HLAD09031	me 3 shkelje	3.990
HLAD09041	me 4 shkelje	5.500
HLAD09051	me 5 shkelje	6.500
HLAD09061	me 6 shkelje	7.500



SHKALLE ALUMINI FAMILJARE ME PLATFORME METALIKE



- Sistemi i mbylljes së sigurisë me mekanizem
- Palosja praktike.
- Gati për t'u përdorur në paketim të vetëm elegant.
- Këmbë plastike prej materiali kundër rrëshqitjes.
- Peshë e mbajtjes 150 kg
- Dekorative per perdorim në shtëpi dhe industri.

Kodi		Çmimi
WLD1H03	1x3	3.500
WLD1H04	1x4	4.500
WLD1H05	1x5	5.500
WLD1H06	1x6	5.900
WLD1H07	1x7	6.900



SHKALLE ALUMINI FAMILJARE ME PLATFORME METALIKE



- Sistemi i mbylljes së sigurisë me mekanizem metalike. • Palosja praktike.
- Peshë e mbajtjes 120 kg



Kodi		Çmimi
WLD3H02	1x2 (Kapaciteti 120kg)	2.900
WLD3H03	1x3 (Kapaciteti 120kg)	3.500
WLD3H04	1x4 (Kapaciteti 120kg)	3.900
WLD3H05	1x5 (Kapaciteti 120kg)	4.900

SHKALLE ALUMINI FAMILJARE ME PLATFORME METALIKE



- Sistemi i mbylljes së sigurisë me mekanizem metalike. • Palosja praktike.
- Këmbë plastike prej materiali kundër rrëshqitjes.



Kodi		Çmimi
WLD3H06	1x6	5.900
WLD3H07	1x7	6.900
WLD3H08	1x8	7.900

SHKALLE ALUMINI ME KOMBINIM



- Dimensione kompakte të palosura për transport dhe ruajtje të lehtë.
- Sistemi i thjeshtë i menteshave me klik.
- Shirita për me shume stabilitet.
- I përshtatshëm për një shumëllojshmëri të gjerë përdorimesh.
- E përshtatshme për përdorim në industri dhe shtëpi.

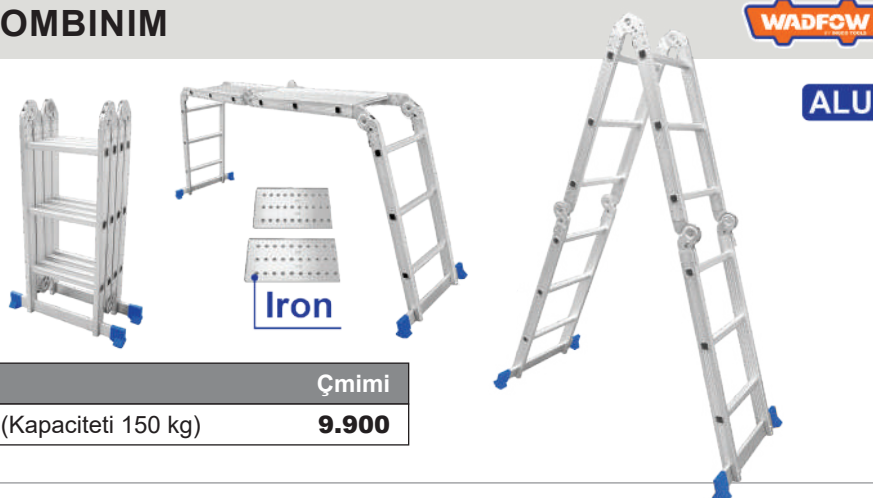

Kodi		Çmimi
WLD7H43	me kombinim 4x3 (Kapaciteti 150 kg)	9.900

KARRELE ALUMINI E PALOSSHME



5.250
BWR9001



Kapaciteti
Permasa

90 kg
42 x 40x 109 cm

KARRELE ME PLATFORME ME 4 RROTA



12.900
BWR3500



Kapaciteti

250 kg
Me 4 rrota

KARRELE ME ZGJATUES



10.500
BWB3000



Kapaciteti

250 kg
Me 4 rrota

KARRELE METALIKE E KUQE



5.990
KMK250



Kapaciteti

250 kg

KARRELE E PALOSSHME



60KGS

3.300
WWB9A06



Kapaciteti
Permasa

60 kg
365 x 380 x 960 mm

KARRELE E PALOSSHME



150KGS

7.500
WWB9A15



Kapaciteti
Permasa

150 kg
710 x 420 x 950 mm

KARRELE ME BAZAMENT



150KG

4.500
WWB1315



Kapaciteti

150 kg

KARRELE ME BAZAMENT



300KG

7.900
WWB1330



Kapaciteti

300 kg

KARROCE DORE E KUQE

5.990

KDK2500



Kapaciteti

100 Kg

KARROCE DORE E GALVANIZUAR



Kodi	Te dhena	Çmimi
BWB7500	200 L	8.500
BWB6500	75 L	3.500

KARROCE DORE E LYER ME DOREZE ME 2 KOMPONENTE

Load (kg):120 Water Capacity(L) :65

4.500

WWB3F02



Kapaciteti

65Lt

KARROCE DORE E LYER ME DOREZE ME 2 KOMPONENTE

Load (kg):150 Water Capacity(L) :90

6.500

WWB8F01



Kapaciteti

90 Lt

KARROCE DORE E LYER ME DOREZE ME 2 KOMPONENTE

Load (kg):150 Water Capacity(L) :90

6.900

WWB8F03



Kapaciteti

90 Lt

GOMA PER KARROCE DORE



Kodi	Te dhena	Çmimi
WWL83302	Mishi 13x13"	1.200
WWL8301	Pneumatike 16"x4.0-8	1.500
WWL8303	E mbushur me shkume 16"x4.0-8	2.500

PESHORE ELEKTRONIKE



Kodi	Te dhena	Çmimi
WEC1510	100 Kg	5.500
WEC1531	300 Kg	7.500
WEC1550	500 Kg	9.500

PESHORE ELEKTRONIKE ME EKTRAN LED

30kg(66LB)

2g graduation

4.950

HESA3303



Per pesha

30 Kg

PESHORE ELEKTRONIKE ME EKTRAN LED



300kg(660LB)
50g graduation

8.500

HESA33003



Per pesha

300 Kg

PESHORE ELEKTRONIKE ME EKTRAN LED



40kg(88LB)
2g graduation

6.690

HESA3404



Per pesha

40 Kg

RAFT MBAJTES ME 5 SERGJENA MDF



1500x700x300mm

3.500

WTS1A73



Kapaciteti
Permase

175 kg
1500 x 700 x 300 mm

RAFT MBAJTES ME 5 SERGJENA MDF



1800x900x400mm

3.900

WTS1A94



Kapaciteti
Permase

175 kg
1800 x 900 x 400 mm

RAFT METALIK ME 5 SERGJENA



7.900

BSR3100



Permase
Kapaciteti

200x120x50cm
50 kg kat

RAFT METALIK ME 4 SERGJENA



2.990

BSR1600



Permase
Kapaciteti

70x30x150cm
50 kg kat

RAFT METALIK ME 5 SERGJENA



Kodi	Te dhena	Çmimi
BSR2100	50 kg kat / 100x45x190 cm	5.500
BSR1900	175 kg kat / 90x40x190 cm	4.500

RAFT METALIK ME 5 SERGJENA



5.500

BSR3001



Permase
Kapaciteti

180x90x40cm
260 kg kat

TREKENDESH RREZIKU



430x430x430mm

690
WYJ3A43



E RE

Masa: 43x43x43cm

SINJALIZUES GOME



1150mm

990
WYJ2A11



E RE

Permasa 1150 mm

BAZAMENT PER SINJALIZUES GOME



6kg

1.190
WYJ2A06

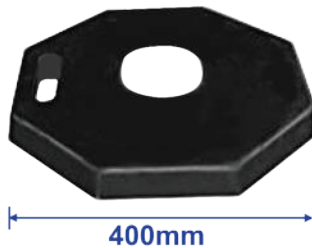

E RE

Permasa 6 mm, Kapaciteti 6 kg

KEND GOME PER SIGURI PARKIMI FOSFORESHENTE



890
BPP2491



E RE

Permasa 80 cm

KON RRUGESH FOSFORESHENT



990
BPP2485



E RE

Permasa 71 cm

KON RRUGESH FOSFORESHENT



2.490
BPP2486



E RE

Permasa 71 cm

KON RRUGESH I HOLLE FOSFORESHENT



990
BPP2481



E RE

Permasa 71 cm

KON RRUGESH I HOLLE FOSFORESHENT



890
BPP2480



E RE

Permasa 45 cm

NGADALSUES SHPEJTESIE ME PJESE FOSFORESHENTE



ERE

2.500

BPP2492



Permasa
Pesha

50x35x5 cm
7.2 kg

RAMPE E ZEZE GOME



ERE

3.690

BPP2499



Permasa

48x32x13 cm

NGADALSUES SHPEJTESIE GOME FOSFORESHENTE



ERE

5.500

BPP2489



Permasa

183 cm

NGADALSUES SHPEJTESIE GOME FOSFORESHENTE



ERE

1.990

BPP2490



Permasa

55 cm

BARRIERE METALIKE PARKINGU



ERE

4.500

BPP2496



Permasa

70x45 cm

PASQYRE TRAFIKU PER MJEDISE TE JASHTME



ERE

3.900

BPP2495



Permasa

60 cm

PASQYRE TRAFIKU PER MJEDISE TE JASHTME



ERE

2.900

BPP2494



Permasa

45 cm

PASQYRE TRAFIKU PER MJEDISE TE JASHTME



ERE

2.500

BPP2493

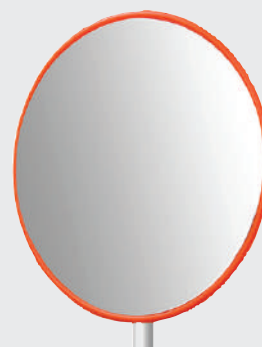

Permasa

30 cm

KOKE LOPATE E HARKUAR



ERE

890
SSF610



Permasa

270*300*352 mm

KOKE LOPATE



ERE

890
SSF620

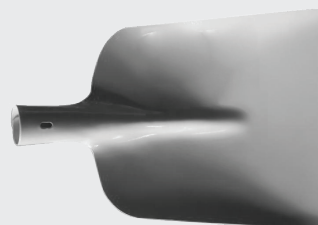

Permasa

250*270*325mm

KOKE LOPATE ME MAJE



ERE

850
SSF615



Permasa

270*295*380 mm

KOKE LOPATE RRUMBULLAKE



ERE

850
SSF605



Permasa

267*300*365 mm

KOKE PER SHAT



ERE



Kodi	Te dhena	Çmimi
SSF686	170 x 190 mm	950
SSF687	190 x 200 mm	990

KOKE SFURKU



ERE

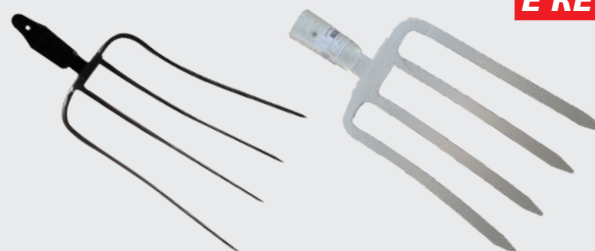

Kodi	Te dhena	Çmimi
SSF645	217*325*445mm i zi	990
SSF647	217*325*445mm i bardhe	1.100

KOKE SQEPARI



ERE

550
607517



Permasa

120 x 2.8 cm

SQEPAR ME BISHT DRURI



ERE

650
607518



Permasa

40 cm

KOKE KAZME E SHESHTE
BORMANN
E RE
950
SSF635

Permasa

100*275mm / 2 Piruna

KOKE KAZME ME HARK
BORMANN
E RE
950
SSF640

Permasa

110*285mm

KREHER METALIK
BORMANN
E RE

Kodi	Te dhena	Çmimi
SSF643	12	850
SSF644	14	890

KREHER METALIK
BORMANN
E RE

Kodi	Te dhena	Çmimi
SSF641	12 te perdredhur	890
SSF642	14 te perdredhur	990

KREHER KOPSHTI PER PASTRIM GJETHESH
BORMANN
E RE
1.290
SSF503

 Metalik
 Dhembel 2

KREHER KOPSHTI PER PASTRIM GJETHESH
BORMANN
E RE
590
SSF679

 Metalik
 Ngjyra

Portokalli

BISHTA DRURI
FORCE
 MACHINERY - TOOLS

E RE

Kodi	Te dhena	Çmimi
607510	Per lopate / 120 cm	250
607511	Per shat / 120 cm	250
607512	Per kreher / 120 cm	240
607513	Per kazme / 90 cm	250
607514	Per sopate / 90 cm	250
607515	Per fshesa / 120 cm	190
607516	Per sqepar / 40 cm	100

BISHTA DRURI
BORMANN
E RE

Kodi	Te dhena	Çmimi
SSF828	Per lopate, bel / 120 cm	250
BFT7032	Per fshesa, lecka / 120 cm	150
SSF838	Per fshesa, lecka / 140 cm	320
SSF840	Per fshesa, lecka / 140 cm	330

**ESPOZITOR PER BISHTAT E
VEGLAVE TE KOPSHTARISE**



1.990
607522



Permasa

40 x 40 x 80 cm

**FSHESE E ASHPER, PER
AMBIENTET E JASHTE**



750
BFT7031



Permasa

40 cm x 2.4 cm

FURCE GOME PASTRIMI



790
BFT7030



Permasa

45 cm x 2.4 cm

**BISHT PER FSHESE /
LECKE DYSHEMEJE**



Kodi	Te dhena	Çmimi
SSF842	120 x 2.2 cm x 2.5 cm	190
SSF836	120 x 2.5 cm	120

**FSHESE ME DIAMETER
BISHTI 25 MM**



290
BFT7001



Permasa

21 x 3 x 18,5 cm

**FSHESE ME DIAMETER
BISHTI 25 MM**



Kodi	Te dhena	Çmimi
BFT7002	24x4 x 11 cm	250
BFT7000	26x3,5 x 10,5 cm	220

**FSHESE ME DIAMETER
BISHTI 25 MM**



350
BFT7003



Permasa

27 x 4,7 x 12 cm

LECKE DYSHEMEJE PAMBUKU



590
BFT7033



Permasa

380 gr

KOSH MBETURINASH INOXI
BORMANN
ERE
3.990
BTW9050

 Kapaciteti
Permasa

 30 L
29x65 cm

KOSH MBETURINASH ME RROTA
BORMANN
ERE

Kodi	Te dhena	Çmimi
BTW9053	55x47x96cm / gri	6.900
BTW9055	55x47x96cm / jeshil	6.900

KOVE ELASTIKE E ZEZE
BORMANN
ERE

Kodi	Te dhena	Çmimi
BHT7986	42 L	990
BHT7987	65 L	1.990

KOVE LLACI E ZEZE DREJTE-KENDORE ME SHKALLE MATESE
BORMANN
ERE

Kodi	Te dhena	Çmimi
BHT7974	40 L / 71.5x39.5x19cm	990
BHT7976	60 L / 72.5x39x28.5cm	1.190
BHT7978	80 L / 78x55.5x30.3cm	1.590

KOVE LLACI E ZEZE ME SHKALLE MATESE
BORMANN
ERE

Kodi	Te dhena	Çmimi
BHT7980	40 L	990
BHT7982	65 L	1.150
BHT7984	90 L	1.590

KOVE LLACI E ZEZE ME SHKALLE MATESE
BORMANN
ERE

Kodi	Te dhena	Çmimi
BHT7970	12 L	390
BHT7971	16 L	450
BHT7972	20 L	590

FURCE PASTRIMI ME DOREZE PLASTIKE
BORMANN
ERE
250
BFT7007

Permasa

13,5x6x3,5 cm

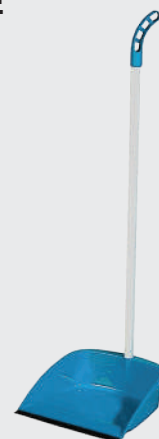
LOPATE FSHESE
BORMANN
ERE
490
BFT7005

 Bishti
Permasa e lopates

 70 cm
26,5x24x11,5 cm

SET FSHESE DHE LOPATE

BORMANN

ERE

290

BFT7008



Permasa

24x6,5x3 cm / 29x20x5,5 cm

SET FSHESE DHE LOPATE

BORMANN

ERE

650

BFT7004



Permasa

26,5x3x19x75 cm / 26x25x8,5x74 cm

ZINXHIR PLASTIK TOP

WADFOW

8mmx25m

ERE

2.500

WYJ6A08



Permasa

8 mm x 25m

ZINXHIR PLASTIK TOP

WADFOW

6mmx25m

ERE

1.790

WYJ6A06



Permasa

6 mm x 25m

LITAR

WADFOW

ERE



Kodi	Te dhena	Çmimi
WRZ1306	6x20m	290
WRZ1308	8x15m	390
WRZ1310	10x15m	490

LITAR TOP

WADFOW

**100%
NEW PP**



Kodi	Te dhena	Çmimi
WRZ2306	6mm / 1300m	13.900
WRZ2308	8mm / 740m	13.900
WRZ2310	10mm / 470m	13.900
WRZ2312	12mm / 320m	13.900

SPANGO MURATORI

**FORCE
CHAIN**

ERE



Kodi	Te dhena	Çmimi
608018	100 gr	250
608036	120 gr	450
608037	400 gr	790

**ZINXHIR METALIK
ME BOBINE
METALI 25 KG**

**FORCE
CHAIN**

ERE



Kodi	Te dhena	Çmimi
608019	3mm / 117.5m	100
608020	4mm / 84.5m	190
608021	5mm / 51.5m	250
608022	6mm / 35.5m	260
608023	8mm / 20.5m	450
608024	10mm / 13m	690

LITAR RROBE



FORCE
CHAIN
E RE

Kodi	Te dhena	Çmimi
608025	4mm / 1m=7.5gr	15
608026	5mm / 1m=11gr	30
608027	6mm / 1m=16gr	35
608028	8mm / 1m=29gr	35
608029	10mm / 1m=45gr	50
608030	12mm / 1m=65gr	60
608031	14mm / 1m=89gr	70

LITAR PUSI



FORCE
CHAIN
E RE

Kodi	Te dhena	Çmimi
608032	6mm (45m / 1kg)	25
608033	8mm (27m / 1kg)	45
608034	10mm (18m / 1kg)	60
608035	12mm (15m / 1kg)	90

QAFORE PER KAFSHE



FORCE
CHAIN
E RE

Kodi	Te dhena	Çmimi
608010	45 x 2.5 cm	490
608011	55 x 2.5 cm	550

QAFORE LEKURE PER KAFSHE



FORCE
CHAIN
E RE

Kodi	Te dhena	Çmimi
608012	45 x 2.5 cm	1.990
608013	65 x 3 cm	2.200

TRUPORE RROBE PER KAFSHE



FORCE
CHAIN
E RE

2.200
608014

Permasa

3.5 cm

QAFORE PER KAFSHE ME THUMBA METALI



FORCE
CHAIN
E RE

2.500
608015

Permasa

70 x 2 cm

QAFORE PER KAFSH ME ZINXHIR



FORCE
CHAIN
E RE

550
608016

Permasa

90 cm

KAPISTRA LOPESH



FORCE
CHAIN
E RE

490
608017



ELEKTRIKE
HIDRAULIKE

Ndricules kantieri LED kundra ujit



Kodi	Fuqia	Drite natyrale	Ndricimi	Rrezja	Cmimi
BLF1005	10 W	4000 K	800 Lm	120	590
BLF1010	20 W	4000 K	1600 Lm	120	650
BLF1015	30 W	4000 K	2400 Lm	120	990
BLF1020	50 W	4000 K	4000 Lm	120	1450
BLF1025	100 W	4000 K	8000 Lm	120	2590
BLF1030	150 W	4000 K	12000 Lm	120	4.990
BLF1035	200 W	4000 K	16000 Lm	120	6.990
BLF1040	300 W	4000 K	24000 Lm	120	11.500



Ndricules kantieri LED kundra ujit, me sensor levizje



Kodi	Fuqia	Drite natyrale	Ndricimi	Cmimi
BLF1910	10 W	4000 K	800 Lm	1.790
BLF1920	20 W	4000 K	1600 Lm	1.990
BLF1930	30 W	4000 K	24000 Lm	2.390
BLF1940	150 W	4000 K	4000 Lm	2.790
BLF1950	100 W	4000 K	8000 Lm	3.990



Ndricules kantieri LED me panel diellor



Kodi	Fuqia	Ndricimi	Cmimi
BLF2350	100 W	1000 Lm	7.500
BLF2550	200 W	2000 Lm	11.900
BLF2650	300 W	2500 Lm	17.500
BLF2750	400 W	3500 Lm	19.900

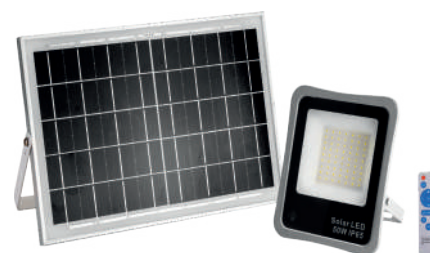

Ndricules LED per rruge, kundra ujit, me panel diellor



Kodi	Fuqia	Ndricimi	Cmimi
BLF3100	100 W	2800 Lm	19.000
BLF3550	150 W	750 Lm	6.990
BLF3600	300 W	1000 Lm	11.900



Ndricules kantieri LED



BLF1500

- Kundra ujit
- Ndricimi: 800 Lm
- Drita natyrale 4000 K



Çmimi
990

Ndricules kantieri LED 50 W



BLF2150

- Me panel dhe sensor levizje
- Telekomande, Kohemates

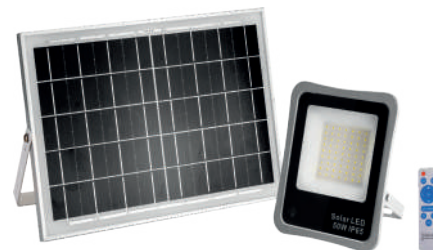

Çmimi
4.990

Ndricules sigurie LED 6.5 W



BLF4000

- Kundra ujit
- Me panel solar 5.5V/1.8W
- Ndricimi: 1000 Lm



Çmimi
2.990

Ndricules kopeshti me panel



BLF4100

- Permase: 13x78 cm
- Ndricimi: 200 Lm
- IP65



Çmimi
4.990

Ndricules kopeshti me panel



BLF4130

- Permase: 12x15x32 cm
- Ndricimi: 120 Lm
- IP44



Çmimi
2.990

Ndricules kopeshti dysh



BLF4110

- Permase: 15x18x36 cm
- Ndricimi: 120 Lm
- IP44
- Me panel



Çmimi
3.690

Ndricules kopeshti dysh



BLF4120

- Permase: 13x18x72 cm
- Ndricimi: 250 Lm
- IP44
- Me panel



Çmimi
4.900



1

2

3

4

5

6

7

8

9

10



 Deklarata jone per ju:

Fuqizoni të dashurit tuaj me dritë dhe ngrohtësi përmes ndriçimit.

**SAMSUNG
LED**

Illuminated

Në vitin 2016, WELLMAX u bë partneri i parë strategjik global i SAMSUNG, aleanca është kontraktuar nga MOU nje memorandum strategjik gjithëpërfshirës e nënshkruar për të zhvilluar produktet e ndricimit LED.

Cilësia premium e Samsung LED dhe aftësia unike e kërkimit dhe zhvillimit te WELLMAX jane bashkuar per ta bere produktin e tyre unik dhe te pa konkureshem.



Te paret ne bote!

Samsung Electronics, furnizuesi më i madh në botë i gjysmëpërçuesve, nënshkroi një marrëveshje gjithëpërfshirëse të partneritetit strategjik me WELLMAX.

MOU identifikon WELLMAX si një nga partneret e parë global te SAMSUNG-ut per produktet e ndricimit.



Influence globale!

Marrëdhënia e SAMSUNG dhe WELLMAX u thellua gjatë viteve në fronte të shumta. WELLMAX ka qenë krenar që ka inkorporuar teknologjinë më të re të çipeve LED të SAMSUNG për të zhvilluar produkte. Në vitin 2016, produktet e WELLMAX u ekspozuan si shembull inovacioni në standat e SAMSUNG në Gjermani.



Një e ardhme e ndritur së bashku!

E nxitur nga globalizimi, konkurrenca brenda industrisë LED po bëhet gjithnjë e më e ashpër. Me teknologjinë e çipit LED të SAMSUNG dhe mbrojtjen e IP-së, WELLMAX mund të garantojë cilësi dhe besueshmëri të produktit për klientët e tij.



Bashkëpunim i përkushtuar!

WELLMAX do të vazhdojë të zgjerojë gamen e produkteve me teknologjinë SAMSUNG LED, duke u ofruar klientëve në mbarë botën produkte me cilësi të lartë dhe të besueshme per klientet. Ne do të shtrijmë produktet dhe mbështetjen tonë profesionale në më shumë vende, duke sjellë dritë dhe ngrohtësi përmes ndriçimit.



Qëllimi i WTC është t'u shërbejë më mirë klientëve tanë të çmuar dhe t'i ndihmojë ata të mbajnë një rritje të fortë të biznesit. Mundësuar nga 3 superfuqite tona:



Ekipi i R&D gjithmone i gatshem për të ekzekutuar dizajn unik, testimin e certifikimin si dhe prodhimin e artikujve te rinj konkures dhe gjithone duke permbushur nevojat e klienteve.



Trajnime te vazhdueshme te bashkpuntoreve tone ne dy aspekte si: know-how dhe show-how per te permiresuar vazhdimisht cilesine e sherbimit dhe produktit.



Bashkpunimi me SAMSUNG dhe labororet e njohur te certifikimit SGS dhe DEGRA bejne qe produktet tona te kalojne cdo certifikim global dhe ti sigurojne klienteve garancine maksimale.

Certifikime:



Llambe LED-PRO SERIES



Kodi	Fuqia	Voltazhi	Intensiteti	Ndricimi	Çmimi
A60CL096	9 W	176-264V	810 lumen	6500 K	190
A60CL094	9 W	176-264V	810 lumen	4000 K	190

Kodi	Fuqia	Voltazhi	Intensiteti	Ndricimi	Çmimi
A60CL126	12 W	176-264V	1160 lumen	6500 K	250

Kodi	Fuqia	Voltazhi	Intensiteti	Ndricimi	Çmimi
A60CL156	15 W	176-264V	1521 lumen	6500 K	290

Llambe LED te erresueshme



- Niveli i përsosur i ndriçimit nga 15-100%.
- Dritë e qetë pa zhurmë.
- Kursimi i energjisë elektrike dhe kursimi i parave.
- Trupi: Alumini i veshur me plastikë që përçon nxehtësinë.
- Përshtatet me të gjithë modelet e pajisjeve per dimmer

Kodi	Fuqia	Voltazhi	Intensiteti	Ndricimi	Çmimi
ADIM096	9 W	176-264V	810 lumen	6500 K	290

Llambe LED me sensor



- Sensori i integruar i dritës dhe sensor i lëvizjes.
- Ndjeshmëria e dritës 360°.
- Konsumi i ulët i energjisë dhe stabilitet i lartë.
- I ndjeshëm ndaj dritës natyrore të ambientit, performancë e saktë
- Ofrohen zgjidhje të shumta ndijuese për t'iu përshtatur skenarëve të ndryshëm

Kodi	Fuqia	Voltazhi	Intensiteti	Ndricimi	Çmimi
ABLSEN096	9 W	176-264V	810 lumen	6500 K	590

Llambe LED me tre ndricime



- 3 opsione ngjyrash në një llambë.
- Memorie inteligjente e integruar.
- Lehtë për t'u instaluar dhe nuk ka nevojë të ndryshoni çelësin tuaj ekzistues.
- Zëvendësoni direkt llambën e vjetër, pa patur nevojën e pajisjeve shtese.
- Trupi: Plastikë e re që përçon nxehtësinë

Kodi	Fuqia	Voltazhi	Intensiteti	Ndricimi	Çmimi
ACLDIM096	9 W	176-264V	810 lumen	3000 K 4000 K 6500 K	250

Llambe LED ECO LITE



- Kursim 5% i energjisë - i njëjti fluks ndriçues me një fuqi më të ulët.
- Pa luhatje te drites dhe ne fuqi te ulet.
- Trup shumë më i vogël.

Kodi	Fuqia	Voltazhi	Intensiteti	Ndricimi	Çmimi
HTECO286	28 W	176-264V	3000 lumen	6500 K	590
HTECO386	38 W	176-264V	4050 lumen	6500 K	790
HTECO456	45 W	176-264V	5000 lumen	6500 K	950

Llambe LED per spote



Kodi	Fuqia	Voltazhi	Intensiteti	Ndricimi	Çmimi
GUCL046	4 W	176-264V	340 lumen	6500 K	190
GUCL044	4 W	176-264V	360 lumen	4000 K	190
GUCL076	7 W	176-264V	595 lumen	6500 K	220
GUCL074	7 W	176-264V	630 lumen	4000 K	220



Kodi	Fuqia	Voltazhi	Intensiteti	Ndricimi	Çmimi
GUCLDIM0656	6.5 W	176-264V	585 lumen	6500 K	290

Llambe LED per ndriçues magazine



Kodi	Fuqia	Voltazhi	Intensiteti	Ndricimi	Çmimi
T8GL186	18 W 120 CM	176-264V	1850 lumen	6500 K	360
T8GLHB186	18 W 120 CM	176-264V	2520 lumen	6500 K	390
T8GLHB226	22 W 150 CM	176-264V	3080 lumen	6500 K	490

Shirit Led



- Permasat: 120 led/m - 5000 mm x 8 mm x 1.3 mm
- Permasat: 240 led/m - 5000 mm x 12 mm x 1.3 mm

Kodi	Fuqia	Voltazhi	LED	Intensiteti	Ndricimi	Çmimi
SLV121206	8 W/M	12 V	120	1000 lumen	6500 K	250
SLV121204	8 W/M	12 V	120	1000 lumen	4000 K	250
SLV122406	14.5 W/M	12 V	240	1500 lumen	6500 K	380
SLV122404	14.5 W/M	12 V	240	1500 lumen	4000 K	380
SLV241206	8 W/M	24 V	120	1000 lumen	6500 K	250
SLV241204	8 W/M	24 V	120	1000 lumen	4000 K	250
SLV242406	14.5 W/M	24 V	240	1500 lumen	6500 K	380
SLV242404	14.5 W/M	24 V	240	1500 lumen	4000 K	380

Spot inkaso LED



Kodi	Fuqia	Voltazhi	Ø	Intensiteti	Ndricimi	Çmimi
UDRSD066	6 W	176-264V	Ø108	330 lumen	6500 K	590
UDRSD096	9 W	176-264V	Ø135	540 lumen	6500 K	690
UDRSD126	12 W	176-264V	Ø158	720 lumen	6500 K	850
UDRSD186	18 W	176-264V	Ø206	1250 lumen	6500 K	950
UDRSD246	24 W	176-264V	Ø282	1680 lumen	6500 K	1.500
Kodi	Fuqia	Voltazhi	<-->	Intensiteti	Ndricimi	Çmimi
UPRBG486	48 W	176-264V	60x60	4800 lumen	6500 K	2.200

Spot jashte muri LED SUNLIGHT



Kodi	Fuqia	Voltazhi	Ø	Intensiteti	Ndricimi	Çmimi
UDSSD126	12 W	176-264V	Ø175	720 lumen	6500 K	990
UDSSD186	18 W	176-264V	Ø220	1250 lumen	6500 K	950
UDSSD246	24 W	176-264V	Ø295	1680 lumen	6500 K	1.500

Plastic series

Kodi	Fuqia	Voltazhi	Ø	Intensiteti	Ndricimi	Çmimi
UDSSR186	18 W	176-264V	Ø226	1850 lumen	6500 K	650
UDSSR246	24 W	176-264V	Ø226	2500 lumen	6500 K	750

Ndricules LED i gjate



Kodi	Fuqia	Voltazhi	<-->	Intensiteti	Ndricimi	Çmimi
UBWCL246	24 W	176-264V	90cm	2160 lumen	6500 K	890
UBWCL366	36 W	176-264V	120cm	3240 lumen	6500 K	1.200
UBWCL426	42 W	176-264V	150cm	3780 lumen	6500 K	1.500

Prozhektor LED/PIR



Kodi	Fuqia	Voltazhi	Intensiteti	Ndricimi	Çmimi
UFLFX10	10 W	176-264V	900 lumen	6500 K	650
UFLFX30	30 W	176-264V	2700 lumen	6500 K	900
UFLFX50	50 W	176-264V	4500 lumen	6500 K	1.200
UFLFX100	100 W	176-264V	9000 lumen	6500 K	2.200
UFLFX150	150 W	176-264V	13500 lumen	6500 K	2.900
UFLFX200	200 W	176-264V	18000 lumen	6500 K	3.900

PIR series

Kodi	Fuqia	Voltazhi	Intensiteti	Ndricimi	Çmimi
UFLFX10SQ	10 W	176-264V	900 lumen	6500 K	1.500
UFLFX30SQ	30 W	176-264V	2700 lumen	6500 K	1.700
UFLFX50SQ	50 W	176-264V	4500 lumen	6500 K	1.900

Llambe LED SMD

9
watt



810 lumen

ED-1044 **6500 K**

ED-1045 **4000 K**

ED-1046 **3000 K**

Çmimi
100

Llambe LED SMD

15
watt



1350 lumen

ED-1066 **6500 K**

ED-1067 **4000 K**

ED-1068 **3000 K**

Çmimi
200

Llambe LED SMD

5
watt



450 lumen

ED-1024 **6500 K**

ED-1025 **4000 K**

ED-1026 **3000 K**

Çmimi
150

Llambe LED SMD

7
watt



420 lumen

ED-66 **6500 K**

ED-67 **4000 K**

ED-68 **3000 K**

Çmimi
180

Llambe LED SMD

5
watt



ED-1021 **4000 K**

ED-1022 **3000 K**

Çmimi
250

Llambe LED SMD

6
watt



450 lumen

ED-1316 **4000 K**

ED-1315 **2700 K**

Çmimi
350

Llambe LED SMD

6500 K



20 watt 1700 lumen

30 watt 2300 lumen

ED-2930 **20 w** **350**

ED-2932 **30 w** **450**

Çmimi

Llambe LED SMD

6500 K



40 watt 3600 lumen

50 watt 4500 lumen

ED-2938 **40 w** **720**

ED-2940 **50 w** **850**

Çmimi

Spot inkaso

3 watt 70 mm / 225 lumen
ED-1135 (6500 K)



Spot inkaso

6 watt 105 mm / 450 lumen
ED-1138 (6500 K)



Spot inkaso

9 watt 125 mm / 675 lumen
ED-1141 (6500 K)



Spot inkaso

12 watt 155 mm / 960 lumen
ED-1154 (6500 K)



Spot inkaso

15 watt 180 mm / 1125 lumen
ED-1134 (6500 K)

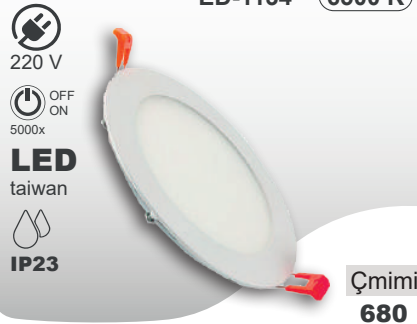

Spot inkaso

18 watt 200 mm / 1350 lumen
ED-1148 (6500 K)

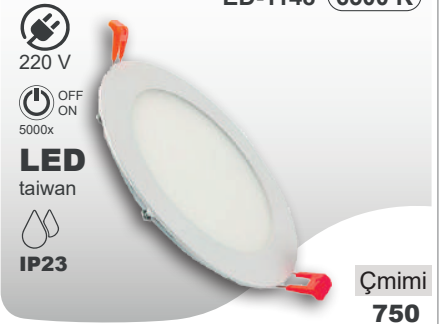

Spot inkaso

24 watt 270 mm / 1800 lumen
ED-1163 (6500 K)



Spot inkaso

6 watt 72 mm / 450 lumen
ED-6005 (6500 K)
ED-6007 (3000 K)



Spot jashte muri

6 watt 120 mm / 450 lumen
ED-1178 (6500 K)

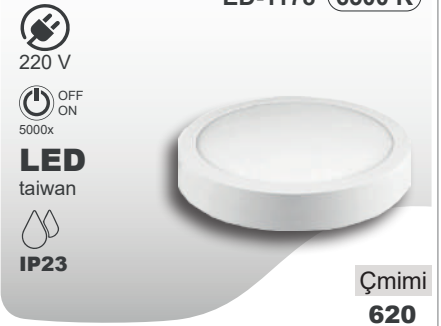

Spot jashte muri

12 watt 175 mm / 1125 lumen
ED-1182 (6500 K)



Spot jashte muri

18 watt 225 mm / 1350 lumen
ED-1188 (6500 K)



Spot jashte muri

24 watt 280 mm / 1800 lumen
ED-1192 (6500 K)



1
2
3
4
5
6
7
8
9
10

Shirit LED

120
LED

1100 lumen

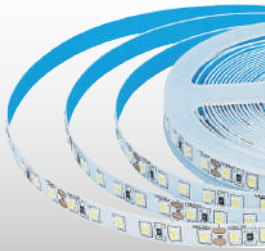

ED-2030 (6500 K)

ED-2032 (4000 K)



Çmimi
600

Shirit LED

240
LED

1260 lumen

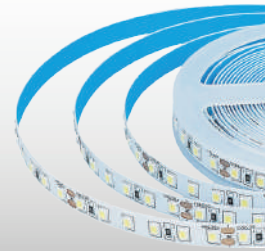

ED-2035 (6500 K)

ED-2037 (4000 K)



Çmimi
1.200

Shirit LED COB

300
LED

10 W / m

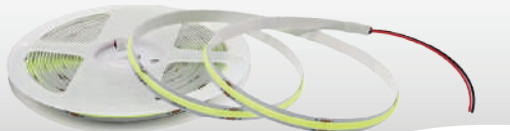

ED-2026 (6500 K)

ED-2026 (4000 K)

Çmimi
1.300

Shirit LED

120
LED

750 lumen / m

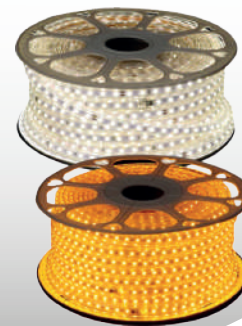

ED-2060 (6500 K)

ED-2062 (4000 K)

Çmimi
300

Shirit LED RGB

50
LED

14.4 W / m - 720 lumen



ED-2160 (RGB)

Çmimi
900

Set shirit LED RGB

50
LED

14.4 W / m - 720 lumen



ED-1565 (RGB)

Çmimi
1.500

Transformatore LED



ED-1564

Kodi	Tensioni	Fuqja	Amperazhi	Çmimi
ED-1537	12 V	60 W	5 A	750
ED-1540	12 V	100 W	85 A	990
AU-1543	12 V	120 W	10 A	1.050
ED-1546	12 V	150 W	12.5 A	1.250
AU-1550	12 V	200 W	16.5 A	1.650
AU-1554	12 V	250 W	21 A	1.800
ED-1555	12 V	320 W	27 A	2.000
AU-1557	12 V	360 W	30 A	2.200
ED-1564	12 V-24	576 W	24 A	1.500

Prozhektor LED

10 watt 800 lumen
ED-110 (6500 K)



LED
taiwan



Çmimi
790

Prozhektor LED

20 watt 1600 lumen
ED-115 (6500 K)



LED
taiwan



Çmimi
990

Prozhektor LED

30 watt 2400 lumen
ED-120 (6500 K)



LED
taiwan

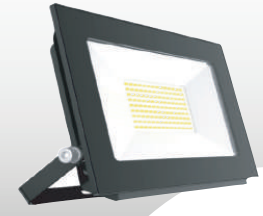

Çmimi
1.100

Prozhektor LED

50 watt 4000 lumen
ED-125 (6500 K)



LED
taiwan



Çmimi
1.300

Prozhektor LED

100 watt 8000 lumen
ED-135 (6500 K)



LED
taiwan



Çmimi
2.300

Prozhektor LED

150 watt 12000 lumen
ED-140 (6500 K)



LED
taiwan



Çmimi
3.400

Prozhektor LED

200 watt 16000 lumen
ED-145 (6500 K)



LED
taiwan



Çmimi
4.300

Prozhektor LED

300 watt 24000 lumen
ED-150 (6500 K)



LED
taiwan



Çmimi
6.200

Prozhektor LED me sensor

10 watt 800 lumen
ED-113 (6500 K)



LED
taiwan

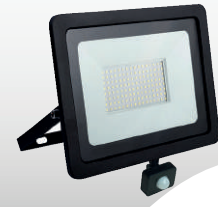

Çmimi
1.600

Prozhektor LED me sensor

30 watt 2400 lumen
ED-123 (6500 K)



LED
taiwan

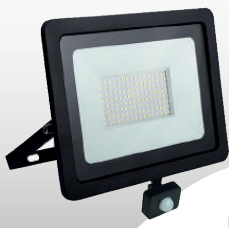

Çmimi
2.200

Prozhektor LED me sensor

50 watt 4000 lumen
ED-128 (6500 K)



LED
taiwan

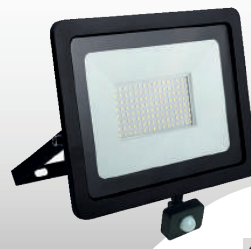

Çmimi
3.000

Prozhektor LED me sensor

100 watt 8000 lumen
ED-138 (6500 K)



LED
taiwan

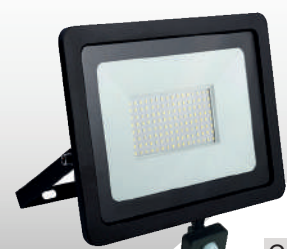

Çmimi
4.300

1
2
3
4
5
6
7
8
9
10

Ndricules magazine

18
watt

60 cm / 1440 lumen

ED-1630 (6500 K)



LED
taiwan



Çmimi
500

Ndricules magazine

36
watt

120 cm / 2880 lumen

ED-1640 (6500 K)



LED
taiwan



Çmimi
690

Ndricules magazine

54
watt

120 cm / 4320 lumen

ED-1650 (6500 K)



LED
taiwan

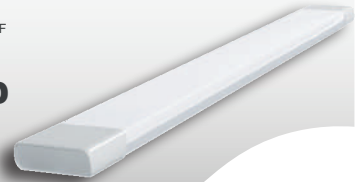

Çmimi
1.200

Ndricules magazine

72
watt

120 cm / 5760 lumen

ED-1655 (6500 K)



LED
taiwan

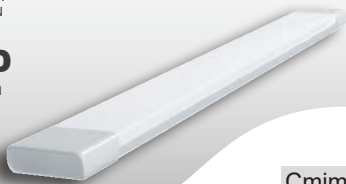

Çmimi
1.500

Spot inkaso

40
watt

60x60 cm / 3200 lumen

ED-5000 (6500 K)



LED
taiwan



Çmimi
1.600

Kase per spot inkaso

60x60 cm

ED-3600

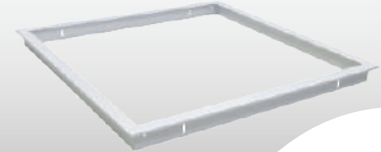

Çmimi
450

Spot jashte muri

6
watt

120x120 mm / 450 lumen

ED-1206 (6500 K)



LED
taiwan



Çmimi
720

Spot jashte muri

12
watt

175x175 mm / 900 lumen

ED-1230 (6500 K)



LED
taiwan



Çmimi
990

Spot jashte muri

18
watt

225x225 mm / 1350 lumen

ED-1210 (6500 K)



LED
taiwan



Çmimi
1.100

Spot jashte muri

24
watt

280x280 mm / 1800 lumen

ED-1220 (6500 K)



LED
taiwan



Çmimi
1.500

Sensor muzgu

10
Amper

ED-3318



Çmimi
550

Sensor levizje

1200
watt

ED-3310



Çmimi
1.100

Kase spoti alumin



Kase spoti alumin

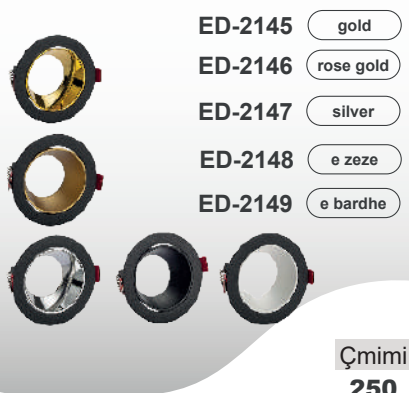

Kase spoti alumin



Ndricules jashte muri me sensor



Ndricules jashte muri me sensor



Ndricules jashte muri me sensor



Ndricules pasqyre



Ndricules pasqyre



Ndricules pasqyre



Sahat elektronik



Kabull interneti CAT6 UTP

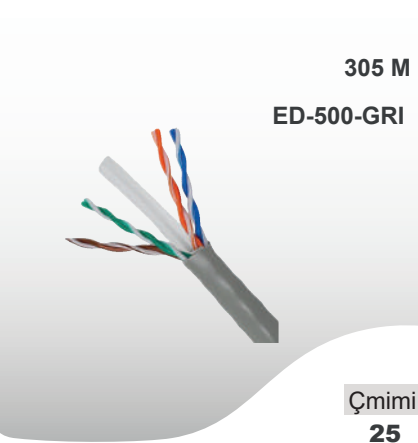

Portollambe GU10



Ndricues muri

6 watt

220 V

5000x

IP44

ED-6051 **3000 K**

ED-6056 **3000 K**

ED-6061 **3000 K**



Çmimi
1.300

Ndricues muri

220 V

5000x

IP44

GU10

ED-633 **E zeze**

ED-633-2 **Gri**

ED-633-1 **E bardhe**

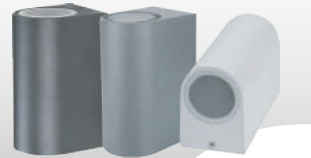

Çmimi
600

Ndricues muri

220 V

IP44

E27

ED-8400



Çmimi
250

Ndricues kopshti

220 V

IP44

E27

ED-7030



Çmimi
1.700

Ndricues kopshti

220 V

IP44

E27

ED-7035



Çmimi
1.900

Ndricues kopshti

220 V

IP44

E27

ED-7810



Çmimi
1.100

Ndricues kopshti

220 V

IP44

E27

ED-8100 **E zeze**

ED-8120 **Baker**

ED-8140 **E bardhe**



Çmimi
820

Ndricues kopshti

220 V

IP44

E27

ED-8105 **E zeze**

ED-8125 **Baker**

ED-8145 **E bardhe**



Çmimi
820

Ndricues kopshti

220 V

IP44

E27

ED-8115 **E zeze**

ED-8135 **Baker**

ED-8155 **E bardhe**



Çmimi
820

Ndricues kopshti

220 V

IP44

E27

Çmimi

ED-7250 (41cm) **1.300**

ED-7275 (55cm) **1.600**

ED-7300 (62cm) **1.800**

ED-7350 (80cm) **2.200**



Ndricues kopshti

220 V

IP44

E27

Çmimi

ED-7600 (41cm) **1.200**

ED-7650 (55cm) **1.500**

ED-7675 (62cm) **1.700**

ED-7700 (80cm) **2.200**

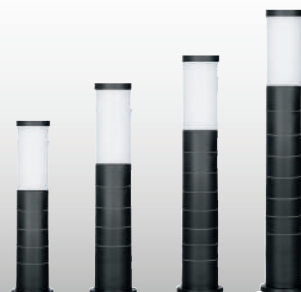

601082

 Çmimi
3.300
Baladeze me 4 priza

25m 3x1.5mm plastike

601083

 Çmimi
5.500
Baladeze me 4 priza

50m 3x1.5mm plastike

601084

 Çmimi
4.500
Baladeze metalike

Me 4 priza 20m 3x2.5mm

601108

 Çmimi
6.900
Baladeze metalike

Me 4 priza 40m 3x2.5mm

601086

 Çmimi
1.690
Baladeze portabel

10m 3x1.5mm

601087

 Çmimi
4.500
Baladeze qe terhiqet

14+2m 3x1.5

601092

 Çmimi
790
Llambe pune 5m, 2x0.75

Celes dhe varese metalike, poc 60W

601097

 Çmimi
250
Adaptor

1x16A ne 3x16A

Zgjatues me 3 priza (i bardhe)

Kodi	Te dhena	Çmimi
601098	2m / 3x1.5mm	450
601099	3m / 3x1.5mm	550
601100	5m / 3x1.5mm	690

Zgjatues me 5 priza (i bardhe)

Kodi	Te dhena	Çmimi
601101	2m / 3x1.5mm	490
601102	3m / 3x1.5mm	590
601103	5m / 3x1.5mm	790

Zgjatues me 3 priza dhe celes (i bardhe)

Kodi	Te dhena	Çmimi
601104	3m / 3x1.5mm	590
601105	5m / 3x1.5mm	790

Zgjatues me 5 priza dhe celes (i bardhe)

Kodi	Te dhena	Çmimi
601074	2m / 3x1.5mm	550
601106	3m / 3x1.5mm	650
601107	5m / 3x1.5mm	890

Baladeze me 4 priza kabull i zi me mbrojtje termale IP20 pa kapak



Kodi	Te dhena	Çmimi
5910000	Bosh, per 50m kabell	1.590
5910020	20m / 3x1.5mm	3.500
5910030	30m / 3x1.5mm	4.900
5910040	40m / 3x1.5mm	5.500

Baladeze me 4 priza kabull i zi me mbrojtje termale IP20 pa kapak



Kodi	Te dhena	Çmimi
5910021	20m / 3x2.5mm	4.900
5910031	30m / 3x2.5mm	5.900
5910041	40m / 3x2.5mm	6.900

Baladeze me 4 priza i zi me mbrojtje termale dhe kapak izolimi nga lageshtia



Kodi	Te dhena	Çmimi
5940000	Bosh, per 50m kabell	1.950
5940020	20m / 3x1.5mm IP44	3.900
5940030	30m / 3x1.5mm IP44	4.900
5940040	40m / 3x1.5mm IP44	5.900

Baladeze me 4 priza i zi me mbrojtje termale dhe kapak izolimi nga lageshtia



Kodi	Te dhena	Çmimi
5940021	20m / 3x2.5mm IP44	4.500
5940031	30m / 3x2.5mm IP44	5.900
5940041	40m / 3x2.5mm IP44	6.900

Baladeze me 4 priza i zi me mbrojtje termale dhe kapak izolimi nga lageshtia METALIKE



Kodi	Te dhena	Çmimi
5940100	Bosh, per 50m kabell	2.990
5940141	40m x 3x2.5 IP44	8.500

Prizë Murale e Gomuare Zezë



Kodi	Te dhena	Çmimi
5510000	1 vënde	290
5520000	2 vënde	450
5530000	3 vënde	450
5540000	4 vënde	750

Zgjatues kabelli me celesme mbrojtje femijesh 3x1.5mm



Kodi	Te dhena	Çmimi
220600031	3 priza / 3m kabell	890
220400031	4 priza / 3m kabell	990

Zgjatues kabelli me mbrojtje femijesh 3x1.5mm



Kodi	Te dhena	Çmimi
230300031	3 priza / 3m kabell	890
230400031	4 priza / 3m kabell	990

Zgjatues kabelli me celes e Zeze me mbrojtje femijesh 3x1.5m



Kodi	Te dhena	Çmimi
230301031	3 priza / 3m kabull	990
230301051	3 priza / 5m kabull	1.290
230401031	4 priza / 3m kabull	1.100
230601031	6 priza / 3m kabull	1.250
230601051	6 priza / 5m kabull	1.490

Zgjatues kabulli portokalli me spine dhe prize me kapak izolimi nga lageshtia



Kodi	Te dhena	Çmimi
5970010	10m 3x1.0mm IP44	1.490
5970020	20m 3x1.0mm IP44	2.300
5970030	30m 3x1.0mm IP44	3.500
5970035	35m 3x1.5mm IP44	3.600

Adaptor i tokëzuar



Kodi	Te dhena	Çmimi
7712000	Me 2 vende	390
7713400	Me 3 vende	490

7713000



Çmimi
390

Adaptor i tokëzuar

Me 3 vënde trekëndësh

714100



Çmimi
120

Adaptor prize

Sistem Anglez

7714200



Çmimi
180

Adaptor shuko

Sistem Anglez/Amerikan I bardhe

7714300



Çmimi
150

Prize shuko femer

Me 5 vende e bardhe

Prize shuko femer

7911000



Çmimi
110

Spine e thjeshte shuko

Mashkull e zeze

7711600



Çmimi
110

Spinë e 90° shuko

Mashkull e kuqe

Kodi	Te dhena	Çmimi
7911700	e drejte e zeze	130
5511700	e gomuar e zeze	220

7711500



Çmimi
100

Spinë e drejtë shuko

Mashkull e kuqe

7913500



Çmimi
150

Spinë e drejtë shuko

Mashkull e zeze

5511500



Çmimi
190

Spinë shuko

Mashkull e gomuar e zeze

5611500



Çmimi
290

Spine trefazore IP44

E gomuar e drejte 3p+E 25A 380/450V

5611700



Çmimi
390

Prize trefazore IP44

E gomuar e drejte 3p+E 25A 380/450V



5610000



Çmimi
450

Prize trefazore murale IP44

Me 1 vend e gomuar 3p+E 25A

<p>5620000</p> <p>ERE</p>  <p>Çmimi 990</p>	<p>5630000</p> <p>ERE</p>  <p>Çmimi 1.590</p>	<p>5610100</p> <p>ERE</p>  <p>Çmimi 990</p>															
<p>Prize trefazore murale IP44</p> <p>Me 2 vende e gomuar 3p+E 25A 380/450V</p>	<p>Prize trefazore murale IP44</p> <p>Me 3 vende e gomuar 3p+E 25A 380/450V</p>	<p>Prize trefazore Binare IP44</p> <p>Me 2 vende e gomuar (1/16A - 1/25A) 1/3p+E 25A 380/450V // 1/ 2p+E 16A 250V</p>															
<p>5610200</p> <p>ERE</p>  <p>Çmimi 1.490</p>	<p>5620100</p> <p>ERE</p>  <p>Çmimi 1.450</p>	<p>5711500</p> <p>ERE</p>  <p>Çmimi 590</p>															
<p>Prize trefazore Binare IP44</p> <p>Me 2 vende e gomuar (1/16A - 1/25A) 1/3p+E 25A 380/450V // 1/ 2p+E 16A 250V</p>	<p>Prize trefazore Binare IP44</p> <p>(2/16A - 1/25A) 1/ 3p+E 25A 380/450V // 2/ 2p+E 16A 250V</p>	<p>Spine industriale trefazore</p> <p>16A 3p+N+E TS40 5X16A 50/60Hz 6h/380/415V</p>															
<p>5711700</p> <p>ERE</p>  <p>Çmimi 790</p>	<p>5710000</p> <p>ERE</p>  <p>Çmimi 950</p>	<p>5811500</p> <p>ERE</p>  <p>Çmimi 850</p>															
<p>Prize industriale trefazore IP44</p> <p>16A 3p+N+E TS40 5X16A 50/60Hz 6h/380/415V</p>	<p>Prize industriale trefazore</p> <p>Ajrore, 16a 3p+N+E TS40 5X16A 50/60Hz 6h/380/415V</p>	<p>Spine industriale trefazore IP44</p> <p>32A 3p+N+E TS40 5X32A 50/60Hz 6h/380/415V</p>															
<p>5811700</p> <p>ERE</p>  <p>Çmimi 890</p>	<p>5810000</p> <p>ERE</p>  <p>Çmimi 1.390</p>	<p>Aspirator tualeti</p> <p>BORMANN</p> <p>IRI</p> 															
<p>Prize industriale trefazore IP44</p> <p>32A 3p+N+E TS40 5X32A 50/60Hz 6h/380/415V</p>	<p>Prize industriale trefazore IP44</p> <p>Ajrore, 32A 3p+N+E TS40 5X32A 50/60Hz 6h/380/415V</p>	<table border="1"> <thead> <tr> <th>Kodi</th> <th>Te dhena</th> <th>Çmimi</th> </tr> </thead> <tbody> <tr> <td>BTW4300</td> <td>Ø125</td> <td>1.590</td> </tr> <tr> <td>2510200</td> <td>Ø100</td> <td>1.290</td> </tr> <tr> <td>2512200</td> <td>Ø120</td> <td>1.290</td> </tr> <tr> <td>2515200</td> <td>Ø150</td> <td>1.450</td> </tr> </tbody> </table>	Kodi	Te dhena	Çmimi	BTW4300	Ø125	1.590	2510200	Ø100	1.290	2512200	Ø120	1.290	2515200	Ø150	1.450
Kodi	Te dhena	Çmimi															
BTW4300	Ø125	1.590															
2510200	Ø100	1.290															
2512200	Ø120	1.290															
2515200	Ø150	1.450															

Kasete plastike transparente IP65



E RE

Kodi	Te dhena	Çmimi
AYKT 203013	20x30x13	1.950
AYKT 253515	25x35x15	2.750
AYKT 304017	30x40x17	3.590
AYKT 355019	35x50x19	4.990
AYKT 304022	30x40x22	3.990

Tub spiral i zi



I RI

Kodi	Te dhena	Çmimi
49100011	11mmx50m	3.950
49100014	14mmx50m	4.250
49100016	16mmx50m	4.450
49100018	18mmx50m	4.750

Kanaline per panel me ngjitje

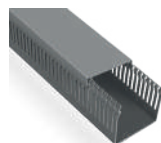

E RE

Kodi	Te dhena	Çmimi
46 025 251	25x25	190
46 025 401	25x40	290
46 025 601	25x60	350
46 040 401	40x40	330
46 040 601	40x60	390

Kanaline dysHEMEJE me ngjitje gri



E RE

Kodi	Te dhena	Çmimi
45050131	50x13	240
45060151	60x15	290
45075181	75x18	390
45090201	90x20	490

Kasete plastike transparente IP65



E RE

Kodi	Te dhena	Çmimi
AYKT 405018	40x50x18	5.590
AYKT 405024	40x50x24	5.900
AYKT 406020	40x60x20	6.500
AYKT 506023	50x60x23	7.900
AYKT 507025	50x70x25	8.900

Tub spiral i zi



I RI

Kodi	Te dhena	Çmimi
49100021	21mmx50m	4.950
49100026	26mmx50m	6.450
49100029	29mmx50m	8.750
49100032	32mmx50m	9.750

Kanaline per panel me ngjitje

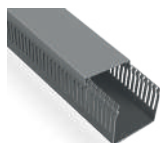

E RE

Kodi	Te dhena	Çmimi
46040801	40x80	590
46060401	60x40	490
46060601	60x60	550
46060801	60x80	590
460601001	60x100	690

Kanaline me ngjitje (2m)

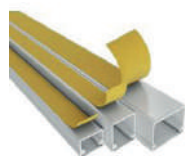

E RE

Kodi	Te dhena	Çmimi
44012121	12x12	90
44015101	15x10	100
44016161	16x16	120
44020101	20x10	150
44025161	25x16	200

49100009



I RI

Çmimi
3.750

Tub spiral guajne i zi

9mm x 50m

Tub spiral i zi



I RI

Kodi	Te dhena	Çmimi
49100037	37mmx50m	12.500
49100042	42mmx50m	14.500
49100050	20mmx50m	22.500
49100063	36mmx50m	29.500

Kanaline dysHEMEJE me ngjitje e bardhe



E RE

Kodi	Te dhena	Çmimi
45090201B	50x13	240
45050131B	60x15	290
45060151B	75x18	390
45075181B	90x20	490

Kanaline me ngjitje (2m)

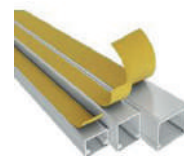

I RI

Kodi	Te dhena	Çmimi
42502511	25x25	240
44040161	40x16	290
44040251	40x25	350
44040401	40x40	390
44060401	60x40	490

Tub spiral me 2 shtresa portokalli

Kodi	Te dhena	Paketimi	Cmimi
PLN-PLSH-16	16mm Portokalli	Top 100m	39
PLN-PLSH-20	20mm Portokalli	Top 100m	45
PLN-PLSH-25	25mm Portokalli	Top 100m	59
PLN-PLSH-32	32mm Portokalli	Top 50m	79



Sonde elektrike metalike

Kodi	Te dhena	Paketimi	Cmimi
PLN-ÇS-5	5mm	40 cope	550
PLN-ÇS-10	10mm	25 cope	690
PLN-ÇS-15	15mm	20 cope	1.250
PLN-ÇS-20	20mm	15 cope	1.590
PLN-ÇS-25	25mm	13 cope	1.790
PLN-ÇS-30	30mm	10 cope	1.990



Sonde elektrike metalike e izoluar

Kodi	Te dhena	Paketimi	Cmimi
PLN-ÇST-5	5mm	40 cope	750
PLN-ÇST-10	10mm	25 cope	990
PLN-ÇST-15	15mm	20 cope	1.590
PLN-ÇST-20	20mm	15 cope	1.890
PLN-ÇST-25	25mm	13 cope	2.250
PLN-ÇST-30	30mm	10 cope	2.750



Pusete plastike gri me kapak me gomine

Kodi	Te dhena	Daljet	Cmimi
PLN-MNH-20C	20x20x20cm	4 dalje	590
PLN-MNH-30C	30x30x30cm	4 dalje	990
PLN-MNH-40C	40x40x40cm	4 dalje	1.990
PLN-MNH-50C	50x50x50cm	4 dalje	4.900



Gozhde kapese kabulli

Kodi	Te dhena	Paketimi	Cmimi
PLN-Ç-0	5mm	40 cope	1.5
PLN-Ç-2	6mm	25 cope	1.9
PLN-Ç-3	8mm	20 cope	2.0
PLN-Ç-4	10mm	15 cope	2.2
PLN-Ç-6	12mm	13 cope	2.4
PLN-Ç-7	16mm	10 cope	49
PLN-Ç-8	20mm	10 cope	7.9



Fiksuese kabulli e bardhe me gozhde



Kodi	Te dhena	Paketimi	Cmimi
BCR5100	3/15	100 Cope	95
BCR5102	3.5/15	100 Cope	99
BCR5104	4/15	100 Cope	99
BCR5106	5/15	100 Cope	110
BCR5108	6/20	100 Cope	129
BCR5110	7/20	100 Cope	139
BCR5112	8/20	100 Cope	159
BCR5114	10/25	100 Cope	199
BCR5116	12/25	100 Cope	290
BCR5118	14/30	50 Cope	250
BCR5120	16/35	50 Cope	290
BCR5122	18/40	50 Cope	350
BCR5124	520/40	50 Cope	390
BCR5126	22/45	50 Cope	450



Sonde elektrike najloni



BHT7812

- Per kabull elektrik
- Gjatesia: 10 m
- 3x1.3 mm



Çmimi
590

Sonde elektrike metalike



BHT7813

- Per kabull elektrik
- Gjatesia: 10 m
- 3x1.3 mm



Çmimi
550

Adaptor me 3 priza



72401

- Fuqia: 2.5A / 230V



Çmimi
190

Sensor levizje



83124

- Rreze: 360 grade



Çmimi
590

Tester per priza



HESST30002

- 30 MA VDE
- Tensioni max: 250V



Çmimi
990

Llampe nate me sensor drite



82830

- Fuqia: 3 W
- 120 lm



Çmimi
590

Bolier uji elektrik

KEWH003W

- Fuqia: 7000 W
- Koha e ngrohjes: 3-5 S
- Rritja e temp. 15°C, prurja e ujit rreth 6.5 L/min
- Rritja e temp. 20°C, prurja e ujit rreth 5 L/min
- E lehtë për tu instaluar
- Set aksesorë instalimi, 1 copë valvul rregulluese



Çmimi
9.900

Bolier uji elektrik

KEWH001W

- Fuqia: 3400 W
- Koha e ngrohjes: 3-5 S
- Prurja e ujit: 3.5 L/min
- E lehtë për tu instaluar
- Me valvul sigurie dhe rregullator



Çmimi
3.900



Bolier uji elektrik

KEWH002W

- Fuqia: 5500 W
- Koha e ngrohjes: 3-5 S
- Rritja e temp. 15°C, prurja e ujit 5 L/min
- Rritja e temp. 20°C, prurja e ujit 4 L/min
- E lehtë për tu instaluar
- Me valvul sigurie dhe rregullator



Çmimi
4.900



Bolier dushi vertikal

KEWH008W

- Fuqia: 1500 W
- Tensioni: 220-240 V
- Kapaciteti: 50 L
- Presioni: 0.75 ± 0.05 MPa
- Trup metalik i papërshkrueshëm nga uji
- Instalim vertikal
- Valvul sigurie shumëfunktionale



Çmimi
14.900



Bolier dushi vertikal

KEWH009W

- Fuqia: 1500 W
- Tensioni: 220-240 V
- Kapaciteti: 80 L
- Presioni: 0.75 ± 0.05 MPa
- Trup metalik i papërshkrueshëm nga uji
- Instalim vertikal
- Valvul sigurie shumëfunktionale



Çmimi
18.500



Bolier dushi vertikal

KEWH010W

- Fuqia: 1500 W
- Tensioni: 220-240 V
- Kapaciteti: 100 L
- Presioni: 0.75 ± 0.05 MPa
- Trup metalik i papërshkrueshëm nga uji
- Instalim vertikal
- Valvul sigurie shumëfunktionale



Çmimi
19.900



Ngrohës uji për kuzhinë

KEWH011W

- Fuqia: 1500 W
- Kapaciteti: 15 L
- Temperaturë e ujit deri në 75°C
- Presioni: 0.75 ± 0.05 MPa
- E lehtë për tu instaluar
- Valvul sigurie multi-funksionale



Çmimi
11.900



Ngrohës uji për kuzhinë

KEWH012W

- Fuqia: 1500 W
- Kapaciteti: 30 L
- Temperaturë e ujit deri në 75°C
- Presioni: 0.75 ± 0.05 MPa
- E lehtë për tu instaluar
- Valvul sigurie multi-funksionale



Çmimi
15.900



FALA



75921
Mishelator kuzhine

- Fuqia 3000 W
- Temperatura 60°C
- Koha e ngruhjes 5 sec

Çmimi
3.500

BORMANN
PRO



BTW3500
Bolier kuzhine / banjo

- Me ekran dixhital LED
- Fuqia 6 kW
- I bardhe

Çmimi
9.900

BORMANN
PRO



BTW3550
Bolier kuzhine / banjo

- Me ekran dixhital LED
- Fuqia 7 kW
- Me set dushi

Çmimi
11.900



- 1
- 2
- 3
- 4
- 5
- 6
- 7
- 8
- 9
- 10



BTW3350
Set dushi Evelyn

- Me dy koka dushi rrumbullake
- Struktura mbajtëse
- Përfshin zorre dushi
- I argjendte

Çmimi
4.990



BTW9024
Set dushi 70 cm

- Me koke rrethore
- Dimensioni i kokës: Ø 11 mm
- Me 5 funksione
- Zorre dushi 1.5 m

Çmimi
2.690



BTW3355
Set dushi Sunny

- Me dy koka dushi rrumbullake dhe katrore
- Struktura mbajtëse
- Përfshin zorre dushi
- I argjendte

Çmimi
12.500



BTW5050
Panel dushi Layla inoxi

- Me 3 funksione
- Gjatesia: 1.5 m
- Me efekt shiu

Çmimi
16.900



BTW5040
Set dushi Eva

- Me dy koka dushi rrethore
- Shkop dhe zorre dushi
- Gjatesia: 1.5 m
- Dimensioni i kokës: Ø20cm

Çmimi
11.500



BTW5060
Panel dushi Layla inoxi

- Me 3 funksione
- Gjatesia: 1.5 m
- I zi me efekt shiu

Çmimi
19.900



BTW3370
Rubinet dushi Spring

- Me set dushi
- Dimensioni i kokes: Ø 35 mm

Çmimi
3.990



BTW3365
Rubinet dushi Spring

- Me set dushi
- Dimensioni i kokes: Ø 35 mm

Çmimi
4.500



BTW3250
Rubinet dushi Sonia

- Me set dushi
- Dimensioni i kokes: Ø 40 mm

Çmimi
4.990



BTW3390
Rubinet dushi Fiona

- Me set dushi
- Dimensioni i kokes: Ø 35 mm

Çmimi
5.990

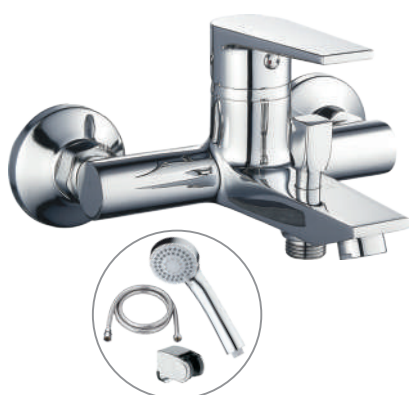

BTW3010
Rubinet dushi Avra

- Me set dushi
- Dimensioni i kokes: Ø 35 mm

Çmimi
5.990



BTW3070
Rubinet Lavamani Sierra

- 35mm
- Me tap lavamani
- Dimensioni: 21x17x13 cm

Çmimi
5.990



BTW3410
Rubinet dushi Eva

- Me set dushi
- Dimensioni i kokes: Ø 35 mm

Çmimi
5.990



BTW3380
Rubinet dushi Violet

- Me set dushi
- Dimensioni i kokes: Ø 35 mm

Çmimi
6.500



BTW3320
Rubinet lavapjate Amelia

- Dimensioni i kokes: Ø 35 mm

Çmimi
7.500

1
2
3
4
5
6
7
8
9
10



BTW3030
Rubinet Lavamani Iris

- 40mm
- Me tap lavamani
- Peshha: 580g

Çmimi
3.990



BTW3240
Rubinet lavamani Sonia

- Dimensioni i kokes: Ø 40 mm

Çmimi
4.250



BTW3360
Rubinet lavamani Spring

- Dimensioni i kokes: Ø 35 mm
- I largjende

Çmimi
4.200



BTW3000
Rubinet lavamani Avra

- Dimensioni i kokes: Ø 35 mm

Çmimi
4.690



BTW3050
Rubinet lavamani Sierra

- Dimensioni i kokes: Ø 40 mm

Çmimi
4.590



BTW3375
Rubinet lavamani Violet

- I gjate
- Dimensioni i kokes: Ø 35 mm

Çmimi
4.990



BTW3405
Rubinet lavamani i gjate Eva

- Dimensioni i kokes: Ø 35 mm

Çmimi
5.500



BTW3385
Rubinet lavamani Fiona

- Dimensioni i kokes: Ø 35 mm

Çmimi
6.900



BTW3060
Rubinet lavamani Sierra

- I gjate
- Dimensioni i kokes: Ø 35 mm

Çmimi
7.990



BTW3140
Rubinet lavapjate Julia

• Dimensioni i kokes: Ø 35 mm

Çmimi
4.250



BTW3340
Rubinet lavapjate Nadia

• Me tub elastik
• Dimensioni i kokes: Ø 40 mm

Çmimi
6.500



BTW3400
Rubinet lavapjate Serena

• Me koke te levizshme
• Dimensioni i kokes: Ø 40 mm

Çmimi
7.500



BTW3100
Rubinet Lavapjate + dushi

• Ydra
• 40mm
• Pesha: 1400g

Çmimi
4.500



BTW3260
Rubinet Lavamani Lida

• Lida
• 40mm

Çmimi
5.200



BTW3080
Rubinet lavamani Silver

• Dimensioni i kokes: Ø 35 mm

Çmimi
3.300



BTW3120
Rubinet lavamani Star

• Dimensioni i kokes: Ø 35 mm

Çmimi
2.690



BTW3150
Rubinet lavapjate

• Me montim mural
• Dimensioni i kokes: Ø 35 mm

Çmimi
3.790



BTW3130
Rubinet lavamani Zebra

• Dimensioni i kokes: Ø 35 mm

Çmimi
2.990



BTW4610
Koke dushi gri e erret

- Dimensioni i kokes: Ø 41 mm*248 mm
- Katrore

Çmimi
650



BTW4620
Koke dushi gri e erret

- Dimensioni i kokes: Ø 85 mm
- Rrethore

Çmimi
690



BTW4630
Koke dushi gri e erret

- Dimensioni i kokes: Ø 93 mm
- Rrethore
- Me 5 opsione

Çmimi
990



BTW4650
Koke dushi i argjende

- Dimensioni i kokes: Ø 81 mm
- Rrethore

Çmimi
850



BTW4660
Koke dushi i argjende

- Dimensioni i kokes: Ø 110 mm
- Me 5 opsione

Çmimi
990



BTW4640
Koke dushi i argjende

- Dimensioni i kokes: Ø 81 mm
- Me 5 opsione

Çmimi
990



BTW3200
Koke dushi e rregullueshme

Çmimi
1.590



BTW3160
Koke dushi me tub 1.5 m

- Gri e lehte

Çmimi
890



BTW3170
Koke dushi me tub 1.5 m

- Gri e forte

Çmimi
890



BTW4600
Koke dushi katrore

• Dimensioni i kokes: Ø 58*234 mm

Çmimi
590



BTW9026
Koke dushi salishenti

• I argjende
• Dimensioni i kokes: Ø 19.8x6.5 cm

Çmimi
1.990



BTW9028
Koke dushi salishenti

• I argjende
• Dimensioni i kokes: Ø 20x20x6.6 mm
• Katrore

Çmimi
1.890



BTW9066
Furce tualeti e bardhe

• Me bisht dhe kapak gold
• Permasa: Ø 9.5x38 cm

Çmimi
950



BTW9032
Furce tualeti e bardhe

• Me bisht druri
• Permasa: Ø 9.7x37 cm

Çmimi
950



BTW9068
Furce tualeti e zeze

• Me bisht dhe kapak gold
• Permasa: Ø 9.5x38 cm

Çmimi
950



BTW9034
Furce tualeti e zeze

• Me bisht druri
• Permasa: Ø 9.7x37 cm

Çmimi
950



BTW9014
Furce tualeti e argjende

• Permasa Ø 9.7x38.4 cm

Çmimi
650



BTW9078
Furce tualeti inoxi

• Permasa: Ø 8.9x36 cm

Çmimi
1.250

1
2
3
4
5
6
7
8
9
10



BTW1085
Kapak tualeti i Aqua Soft

- Me mbeshetese inoxi
- Pesha 2020 gr
- Permasa 430x360 mm

Çmimi
2.990



BTW1070
Kapak tualeti Aries Soft

- Me mbeshetese inoxi
- Pesha 2280 gr
- Permasa 445x360 mm

Çmimi
2.990



BTW1010
Kapak tualeti Gemini Soft

- Me mbeshetese inoxi
- Pesha 2551 gr
- Permasa 465x360 mm

Çmimi
2.990



BTW1000
Kapak tualeti Hydra Soft

- Me mbeshetese inoxi
- Pesha 2590 gr
- Permasa 450x355 mm

Çmimi
2.990



BTW1080
Kapak tualeti Leo Soft

- Me mbeshetese inoxi
- Pesha 2100 gr
- Permasa 445x340 mm

Çmimi
2.990



BTW1040
Kapak tualeti Libra Soft

- Me mbeshetese inoxi
- Pesha 2268 gr
- Permasa 435x350 mm

Çmimi
2.990



BTW1020
Kapak tualeti Norma Soft

- Me mbeshetese inoxi
- Pesha 2460 gr
- Permasa 425x366 mm

Çmimi
2.990



BTW1030
Kapak tualeti Saggita Soft

- Me mbeshetese inoxi
- Pesha 2419 gr
- Permasa 450x375 mm

Çmimi
2.990



BTW1075
Kapak tualeti Virgo Soft

- Me mbeshetese inoxi
- Pesha 2520 gr
- Permasa 440x345 mm

Çmimi
2.990



BTW9070
Kosh mbeturinash gri 6 Lt

- Me mbyllje te ngadalte
- Permasa: 20.3x26x30.5 cm

Çmimi
2.200



BTW9062
Kosh mbeturinash i bardhe

- Me kapak gold, 5 Lt
- Permasa: 20.5x26.8 cm

Çmimi
1.900



BTW9016
Kosh mbeturinash 5 Lt

- I kromuar
- Permasa: 20.5x28 cm

Çmimi
1.290



BTW9064
Kosh mbeturinash i zi 5 Lt

- Me kapak gold
- Permasa: 20.5x26.8 cm

Çmimi
1.900



BTW9010
Mbajtese letrash higjenike

- Inox
- Permasa: 22.5x12x26 cm

Çmimi
4.500



BTW9012
Mbajtese letrash tualeti

- Inoxi
- Katrore
- Permasa 28x10.1x26.5 cm

Çmimi
5.200



BTW9018
Mbajtese tualeti inox

- Me kapak
- Permasa: 13.5x5x14 cm

Çmimi
1.150



BTW9020
Mbajtese letrash tualeti

- Inox
- Permasa: 15.2x6x10.5 cm

Çmimi
1.100



BTW9056
Mbajtese letrash tualeti i zi

- Permasa: 15.2x6x10.5 cm

Çmimi
1.150



BTW4850
Mbajtese peshqiri

- Inoksi
- Permasa: 3 cm

Çmimi
2.990



BTW9000
Mbajtese peshqiri

- E dyfishte
- E kromuar
- Permasa 64.5x12x5.2 cm

Çmimi
2.350



BTW9002
Mbajtese peshqiri

- Rrethore
- E argjende
- Permasa 15.5 x18 cm

Çmimi
990



BTW9052
Mbajtese sapuni i lengshem

- Ngjyre e bardhe
- Plastik dhe dru bamboo
- Permasa 7.2x16.5 cm

Çmimi
690



BTW9051
Mbajtese furca dhembesh

- Ngjyre e bardhe
- Me baze bamboo
- Permasa 7.2x16.5 cm

Çmimi
490



BTW9058
Shishe qeramike

- Per sapun te lengshem
- Me detaje gold
- Permasa: 7.2x17 cm

Çmimi
790



BTW9060
Mbajtese furca dhembesh

- Ngjyre e zeze
- Me detaje gold
- Permasa 7.2x11 cm

Çmimi
690



BTW4700
Suport dushi inoksi

- Gjatesia: 71 cm
- Permasa: 25 mm

Çmimi
1.390



BTW4710
Suport dushi inoksi

- Gjatesia: 65 cm

Çmimi
1.990



BTW3220
Tub spiral per koke dushi

• Gjatesia: 1.5 m

Çmimi
490



BTW3210
Tub spiral per koke dushi

• Gjatesia: 2 m

Çmimi
590



BTW9030
Zorre dushi argjendi

• Gjatesia: 1.5 m

Çmimi
790

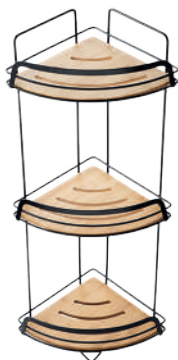

BTW9040
Raft tualeti

• Me 3 kate druri trekendore
• Me strukture te zeze metali
• Permasa: 20x20x63 cm

Çmimi
2.900



BTW9042
Raft tualeti

• Me 3 kate druri trekendore
• 1 kromuar
• Permasa: 20.8x57 cm

Çmimi
2.350



BTW3270
Rubinet per uje te ftohte

• 1/2"x3/4"

Çmimi
690



BTW3435
Rubinet per uje te ftohte

• I gjate, Nina
• Me helika 1/2"x3/4"

Çmimi
1.590



BTW3440
Rubinet per uje te ftohte

• I verdhe
• 1/2"x3/4"

Çmimi
1.290



BTW3430
Rubinet per uje te ftohte

• River
• 1/2"x3/4"

Çmimi
990



Mbajtëse furcash ovale e kromuar **FALA**

69301

Mbajtëse sapuni ovale e kromuar **FALA**

69302



Çmimi
690



Çmimi
690

Mbajtëse letre tualeti e kromuar **FALA**

69305

Mbajtëse letre tualeti e kromuar **FALA**

69317



Çmimi
850



Çmimi
990

Mbajtëse peshqiri tualeti ovale **FALA**

69306



Çmimi
990

Mbajtëse peshqiri tualeti katrore **FALA**



Çmimi
1.490

Mbajtëse sapuni metalike 20 cm **FALA**

69375



Çmimi
990

Mbajtëse sapuni murale 500 ml **FALA**



Çmimi
950

Zhblllokuese lavamani 7cm **VOREL**

55500



Çmimi
1.490

Zhblllokuese tubi **VOREL**



Kodi	Permasa	Çmimi
55541	1.5m / 5mm	290
55542	3m / 6mm	390

Zhblllokuese tubi 5m / 9mm **VOREL**

55544



Çmimi
990

Zhblllokuese tubi 3m / 6mm **WADFCW**

WDD2303



Çmimi
350





3.200

75801
Mishelator lavamani Inox Steely
17.5cm



3.500

75718
Mishelator lavamani Inox
17.5cm



3.690

75716
Mishelator kuzhine Inoxi Steely
37cm



4.690

75719
Mishelator kuzhine Inoxi me
koke te zgjatshme 20cm Steely
40cm



3.900

75802
Mishelator lavamani Inox Steely
11.5cm



6.900

75806
Mishelator parukerie Inoxi me
koke dushi te zgjatshme Steely



16.900

75665
Salishent dushi Inoxi katror
Steely 87-131 cm



4.500

75803
Mishelator lavamani Inox Steely
14cm



7.500

75805
Mishelator kuzhine Inoxi me
qafe te zgjatshme Steely



11.500

75662
Salishent dushi Inoxi I
rumbullaket Steely 96-126 cm



19.900

75813
Salishent dushi RETRO BLACK
klasik me 2 koka 95-130 cm



3.990

75853
Mishelator kuzhine Steely
BLACK 2, 35 cm



8.900

75816
Mishelator dushi RETRO BLACK
3 me 1 koke dushi



9.900

75884
Mishelator kuzhine BLACK
NOIR me koke te levizshme dhe
zgjatje 43cm



4.500

75707
Mishelator kuzhine me tub
fleksibel te kuq



3.900

75706
Mishelator kuzhine me tub fleksibel te
bardhe



9.500

75815
Mishelator lavamani l gjate
RETRO BLACK 24cm



19.900

75883
Salishent dushi BLACK NOIR
katrore me 2 koka dushi 95-135
cm

1

2

3

4

5

6

7

8

9

10

PILETE DUSHI HORIZONTALE



Kodi Permasa Çmimi

75360	30 cm	4.200
75361	40 cm	4.690
75362	50 cm	5.200
75363	60 cm	6.500
75364	70 cm	6.900
75365	80 cm	7.500
75366	90 cm	7.900

PILETE DUSHI HORIZONTALE ME VRIMA



Kodi Permasa Çmimi

75367	30 cm	4.500
75368	40 cm	4.900
75369	50 cm	5.500
75370	60 cm	5.900
75371	70 cm	6.900
75372	80 cm	7.500
75373	90 cm	7.900

PILETE DUSHI HORIZONTALE KATRORE

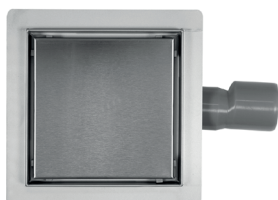

Kodi Permasa Çmimi

75334	150 x 150 cm	4.900
75335	200 x 200 cm	5.500
75336	250 x 250 cm	5.900



220

75327
Set filter metalik mishelatori universal + 24 gomina



950

75484
Pilete lavamani metalik G5/4 I kromuar



990

75625
Koke dushi DETIFOS rrumbullake e kromuar me 5 funksione



790

75632
Koke dushi FOBOS katrore e kromuar me 1 funksion



350

75483
Pilete lavamani plastik G5/4



490

75627
Koke dushi Delta rrumbullake e kromuar me 5 funksione



990

75634
Koke dushi DIONE rrumbullake e kromuar me 5 funksione + buton stop



490

75536
Mbajtese koke dushi e kromuar dhe kapje anesore

TUB FLEKSIBEL F/F 1/2" 1/2"

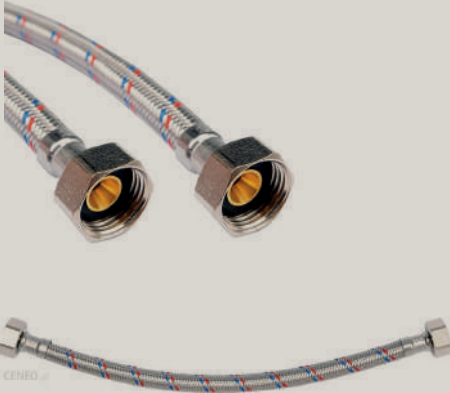

Kodi	Permasa	Çmimi
71800	1/2" 1/2" 300 mm	250
71801	1/2" 1/2" 400 mm	290
71802	1/2" 1/2" 500 mm	320
71803	1/2" 1/2" 600 mm	350
71804	1/2" 1/2" 800 mm	380
71805	1/2" 1/2" 1000mm	390

TUB FLEKSIBEL F/M 1/2" 1/2"



Kodi	Permasa	Çmimi
71820	1/2" 1/2" 300 mm	290
71821	1/2" 1/2" 400 mm	320
71822	1/2" 1/2" 500 mm	350
71823	1/2" 1/2" 600 mm	360
71824	1/2" 1/2" 800 mm	380
71825	1/2" 1/2" 1000mm	450

TUB FLEKSIBEL F/F 3/8" 3/8"



Kodi	Permasa	Çmimi
71814	3/8" 3/8" 300 mm	230
71815	3/8" 3/8" 400 mm	250
71816	3/8" 3/8" 500 mm	280
71817	3/8" 3/8" 600 mm	290
71818	3/8" 3/8" 800 mm	350
71819	3/8" 3/8" 1000mm	390

TUB FLEKSIBEL F/M 3/8" 3/8"



Kodi	Permasa	Çmimi
71833	3/8" 3/8" 300 mm	250
71834	3/8" 3/8" 400 mm	280
71835	3/8" 3/8" 500 mm	290
71836	3/8" 3/8" 600 mm	310
71837	3/8" 3/8" 800 mm	330
71838	3/8" 3/8" 1000mm	350



190

75564

Mbajtëse koke dushi plastike e kromuar me kapje anësore



Zorre dushi inox I kromuar 1.5m

Kodi	Permasa	Çmimi
75645	1.5 m	290
75647	2.0 m	350



Zorre dushi inoxi I bardhe 1.5m

Kodi	Permasa	Çmimi
75652	1.5 m	450
75653	2.0 m	490



Zorre dushi argjend I lemuar 1.5m

Kodi	Permasa	Çmimi
75654	1.5 m	790
75655	2.0 m	950

RUBINET LAVAMANI
BRONZI

URBAN



Pilete, aksesoret e montimit dhe tubat fleksibel 3/8"x350 mm te perfshira ne paketim

Kodi	Paketimi	Çmimi
658781	24 cope	1.900

RUBINET BIDE
BRONZI

URBAN



Pilete, aksesoret e montimit dhe tubat fleksibel 3/8"x350 mm te perfshira ne paketim

Kodi	Paketimi	Çmimi
658780	24 cope	2.000

RUBINET DUSHI
BRONZI

URBAN



Rozetat Ø 35 mm, zgjatuesit 1/2", tub 1.5 m, mbajtese dhe koke dushi te perfshira ne paketim

Kodi	Paketimi	Çmimi
658779	12 cope	2.200

RUBINET LAVAMANI
BRONZI

ELEGANCE



Pilete, aksesoret e montimit dhe tubat fleksibel 3/8"x350 mm te perfshira ne paketim

Kodi	Paketimi	Çmimi
658784	12 cope	2.800

RUBINET BIDE
BRONZI

ELEGANCE



Pilete, aksesoret e montimit dhe tubat fleksibel 3/8"x420 mm te perfshira ne paketim

Kodi	Paketimi	Çmimi
658783	12 cope	2.900

RUBINET DUSHI
BRONZI

ELEGANCE



Rozetat Ø 35 mm dhe zgjatuesit 1/2" te perfshira ne paketim

Kodi	Paketimi	Çmimi
658782	12 cope	3.300

RUBINET LAVAMANI
BRONZI

artic



Pilete, aksesoret e montimit dhe tubat fleksibel 3/8"x350 mm te perfshira ne paketim

Kodi	Paketimi	Çmimi
658787	12 cope	4.500

RUBINET BIDE
BRONZI

artic



Pilete, aksesoret e montimit dhe tubat fleksibel 3/8"x420 mm te perfshira ne paketim

Kodi	Paketimi	Çmimi
658786	12 cope	4.900

RUBINET DUSHI
BRONZI

artic



Rozetat Ø 35 mm dhe zgjatuesit 1/2" te perfshira ne paketim

Kodi	Paketimi	Çmimi
658785	12 cope	5.000

RUBINET LAVAMANI
BRONZI

artic long



Pilete, aksesoret e montimit dhe tubat fleksibel 3/8"x350 mm te perfshira ne paketim

Kodi	Paketimi	Çmimi
658788	12 cope	3.900

RUBINET LAVAMANI
BRONZI

ELEGANCE LONG



Pilete, aksesoret e montimit dhe tubat fleksibel 3/8"x350 mm te perfshira ne paketim

Kodi	Paketimi	Çmimi
658789	12 cope	2.900

RUBINET LAVAPJATE
BRONZI

artic KITCHEN



Aksesoret e montimit dhe tubat fleksibel 3/8"x350 mm te perfshira ne paketim

Kodi	Paketimi	Çmimi
658790	12 cope	3.900

RUBINET LAVAPJATE
BRONZI

URBAN KITCHEN



Aksesoret e montimit dhe tubat fleksibel 3/8"x350 mm te perfshira ne paketim

Kodi	Paketimi	Çmimi
658791	12 cope	2.900

RUBINET LAVAPJATE
BRONZI

artic KITCHEN



Aksesoret e montimit dhe tubat fleksibel 3/8"x350 mm te perfshira ne paketim

Kodi	Paketimi	Çmimi
658792	12 cope	2.900

RUBINET LAVAPJATE
BRONZI

artic KITCHEN



Aksesoret e montimit dhe tubat fleksibel 3/8"x350 mm te perfshira ne paketim

Kodi	Paketimi	Çmimi
658793	12 cope	1.500

SET SHATTAF
BRONZI

URBAN



Koka me siguresse, tub 1.5 m, dhe mbajttese te perfshira ne paketim

Kodi	Paketimi	Çmimi
658794	12 cope	890

SET SHATTAF
BRONZI

artic



Koka me siguresse, tub 1.5 m, dhe saracineska me mbajttese te perfshira ne paketim

Kodi	Paketimi	Çmimi
658795	12 cope	1.990

SET SHATTAF INOKS
BRONZI

artic



Koka me siguresse, tub 1.5 m, dhe saracineska me mbajttese te perfshira ne paketim

Kodi	Paketimi	Çmimi
658796	12 cope	1.590

KOKE DUSHI ABS



Kodi	Permasa	Çmimi
658750	55x110mm	150

KOKE DUSHI ABS



Kodi	Permasa	Çmimi
658751	30x205mm	290

KOKE DUSHI ABS



Kodi	Permasa	Çmimi
658752	Ø 100 mm	200

KOKE DUSHI ABS



Kodi	Permasa	Çmimi
658753	Ø 100 mm	250

SET KOKE DUSHI ABS



Kodi	Permasa	Çmimi
658754	Ø 100 mm	490

SALISHENT

artic SHOWER



3F



TUB DUSHI



Kodi	Permasa	Çmimi
658755	1.5 M	150

TUB DUSHI INOX



Kodi	Permasa	Çmimi
658756	1.5 M	350

Kodi	Permasa	Çmimi
658757	144x40 cm	5.900

MINIFILTER 1/2"x1/2"

Kodi	Paketimi	Çmimi
658800	12 cope	390

MINIFILTER 1/2"x3/4"

Kodi	Paketimi	Çmimi
658801	12 cope	450

SARAÇINESKE 1/2"

Kodi	Paketimi	Çmimi
658799	12 cope	550

PILETE LAVAMANI

Kodi	Materiali	Çmimi
658761	Plastik	200

PILETE LAVAMANI

Kodi	Materiali	Çmimi
658797	Zink	390

SET AKSESORESH 6 PC

Kodi	Materiali	Çmimi
658798	Alumin	2.500

GALIXHANT KASETE

Kodi	Lartesia	Çmimi
658760	28 cm	750

TUB FURNIZIMI

Kodi	Gjatesia	Çmimi
658758	1.5 m	250

TUB SHKARKIMI

Kodi	Gjatesia	Çmimi
658759	1.5 m	250

RAKORDE HIDRAULIKE

3263/ 4263



MANIKOTE PN16

Kodi	Permasa	Modeli	Paketimi	Çmimi
3263/2020	20 x 20 mm	PN16	50 cope	100
3263/2525	25 x 25 mm	PN16	50 cope	150
3263/3232	32 x 32 mm	PN16	50 cope	200
3263/4040	40 x 40 mm	PN16		300
3263/5050	50 x 50 mm	PN16		400
3263/6363	63 x 63 mm	PN16		600
4263/7575	75 x 75 mm	PN16		1.100
4263/9090	90 x 90 mm	PN16		1.700
4263/1111	110 x 110 mm	PN16		2.400
4262/1212	125 x 125 mm	PN16		3.500

3263



MANIKOTE ME REDUKSION PN16

Kodi	Permasa	Modeli	Paketimi	Çmimi
3263/2520	25 x 20mm	PN16	50 cope	180
3263/3225	32 x 25mm	PN16	50 cope	250
3263/4032	40 x 32mm	PN16		330
3263/5040	50 x 40mm	PN16		500
3263/6340	63 x 40mm	PN16		650
3263/6350	63 x 50mm	PN16		700

3673 / 4673



MANIKOTE TI PN16

Kodi	Permasa	Modeli	Paketimi	Çmimi
3673/2020	20 x 20 x 20 mm	PN16	50 cope	200
3673/2525	25 x 25 x 25 mm	PN16	50 cope	250
3673/3232	32 x 32 x 32 mm	PN16		300
3673/4040	40 x 40 x 40 mm	PN16		550
3673/5050	50 x 50 x 50 mm	PN16		800
4673/6363	63 x 63 x 63 mm	PN16		1.100
4673/7575	75 x 75 x 75 mm	PN16		2.000
4673/9090	90 x 90 x 90 mm	PN16		2.700
4673/1111	110 x 110 x 110 mm	PN16		3.500

RAKORDE HIDRAULIKE

3653/4653

MANIKOTE TI F/MASHKULL PN16

Kodi	Permasa	Modeli	Paketimi	Çmimi
3653/0201	20 x ½" x 20	PN16	50 cope	170
3653/0202	20 x ¾" x 20	PN16	50 cope	170
3653/0252	25 x ¾" x 25	PN16	50 cope	240
3653/0323	32 x 1" x 32	PN16		300
3653/0404	40 x 1¼" x 40	PN16		500
3653/0405	40 x 1½" x 40	PN16		500
3653/0505	50 x 1½" x 50	PN16		700
3653/0506	50 x 2" x 50	PN16		750
4653/0636	63 x 2" x 63	PN16		960
4653/0757	75 x 2½" x 75	PN16		1.500
4653/0908	90 x 3" x 90	PN16		2.400
4653/1109	110 x 4" x 110	PN16		3.500



3298/ 4300

BRRYL

Kodi	Permasa	Modeli	Paketimi	Çmimi
3298/2020	20 x 20 mm	PN16	50 cope	100
3298/2525	25 x 25 mm	PN17	50 cope	200
3298/3232	32 x 32 mm	PN18		250
3298/4040	40 x 40 mm	PN19		400
3298/5050	50 x 50 mm	PN50		500
4300/6363	63 x 63 mm	PN21		750
4300/7575	75 x 75 mm	PN22		1.500
4300/9090	90 x 90 mm	PN23		2.000
4300/1111	110 x 110 mm	PN24		3.000



3294/4294

BRYLL F/MASHKULL PN16

Kodi	Permasa	Modeli	Paketimi	Çmimi
3294/3201	20 x ½"	PN16	50 cope	80
3294/3252	25 x ¾"	PN16	50 cope	100
3294/3323	32 x 1"	PN16	50 cope	180
3294/3404	40 x 1¼"	PN16		300
3294/3405	40 x 1½"	PN16		300
3294/3505	50 x 1½"	PN16		400
4294/3636	63 x 2"	PN16		650



RAKORDE HIDRAULIKE

3253/ 4253



MANIKOTE F/MASHKULL PN16

Kodi	Permasa	Modeli	Çmimi
3253/0201	20 x ½"	PN16	80
3253/0202	20 x ¾"	PN16	80
3253/0252	25 x ¾"	PN16	100
3253/0253	25 x 1"	PN16	100
3253/0322	32 x ¾"	PN16	130
3253/0323	32 x 1"	PN16	120
3253/0403	40 x 1"	PN16	200
3253/0404	40 x 1¼"	PN16	200
3253/0405	40 x 1½"	PN16	200
3253/0406	40 x 2"	PN16	300
3253/0505	50 x 1½"	PN16	300
3253/0506	50 x 2"	PN16	500
3253/0635	63 x 1½"	PN16	500
3253/0636	63 x 2"	PN16	500
3253/0637	63 x 2½"	PN16	900
4253/0757	75 x 2½"	PN16	1.200
4253/0908	90 x 3"	PN16	1.100
4253/1109	110 x 4"	PN16	2.500
4252/1259	125 x 4"	PN16	

3205



FASHETE ME QAFORE PN16

Kodi	Permasa	Modeli	Çmimi
3205/0631	63 x ½"	PN16	700
3205/0632	63 x ¾"	PN16	750
3205/0633	63 x 1"	PN16	790
3205/0751	75 x ½"	PN16	850
3205/0752	75 x ¾"	PN16	890
3205/0753	75 x 1"	PN16	950
3205/0901	90 x ½"	PN16	950
3205/0902	90 x ¾"	PN16	990
3205/0903	90 x 1"	PN16	990
3205/1101	110 x ½"	PN16	990
3205/1102	110 x ¾"	PN16	990
3205/1103	110 x 1"	PN16	1.100

RAKORDE HIDRAULIKE

4202/3202

FASHETE ME QAFORË PN10

Kodi	Permasa	Modeli	Çmimi
4202/0251	25 x ½"	PN10	120
4202/0252	25 x ¾"	PN10	120
3202/0321	32 x ½"	PN10	120
3202/0322	32 x ¾"	PN10	170
4202/0323	32 x 1"	PN10	170
3202/0401	40 x ½"	PN10	200
3202/0402	40 x ¾"	PN10	200
3202/0403	40 x 1"	PN10	200
3202/0501	50 x ½"	PN10	220
3202/0502	50 x ¾"	PN10	220
3202/0503	50 x 1"	PN10	220
3202/0631	63 x ½"	PN10	300
3202/0632	63 x ¾"	PN10	300
3202/0633	63 x 1"	PN10	300
3202/0635	63 x 1½"	PN10	350
3202/0751	75 x ½"	PN10	350
3202/0752	75 x ¾"	PN10	350
3202/0753	75 x 1"	PN10	350
3202/0755	75 x 1½"	PN10	400
3202/0756	75 x 2"	PN10	400
3202/0901	90 x ½"	PN10	400
3202/0902	90 x ¾"	PN10	400
3202/0903	90 x 1"	PN10	400
3202/0905	90 x 1½"	PN10	450
3202/0906	90 x 2"	PN10	450
3202/1101	110 x ½"	PN10	500
3202/1102	110 x ¾"	PN10	500
3202/1103	110 x 1"	PN10	500
3202/1105	110 x 1½"	PN10	500
3202/1106	110 x 2"	PN10	500
3202/1253	125 x 1"	PN10	650
3202/1255	125 x 1½"	PN10	750
3202/1256	125 x 2"	PN10	790
4202/1403	140 x 1"	PN10	900
4202/1405	140 x 1½"	PN10	900
4202/1406	140 x 2"	PN10	900
4202/1603	160 x 1"	PN10	1.200
4202/1605	160 x 1½"	PN10	1.200
4202/1606	160 x 2"	PN10	1.200
4202/2003	200 x 1"	PN10	2.400
4202/2005	200 x 1½"	PN10	2.400
4202/2006	200 x 2"	PN10	2.400



1

2

3

4

5

6

7

8

9

10

RAKORDE HIDRAULIKE

3201



FASHETE ME QAFORE ME RRESHKITJE PN6

Kodi	Permasa	Modeli	Çmimi
3201/0501	50 x ½"	PN6	250
3201/0502	50 x ¾"	PN6	250
3201/0632	63 x ¾"	PN6	250

4200



UNAZE GOME PER FASHETE ME QAFORE ME RRESHKITJE

Kodi	Permasa	Çmimi
4200/0032	32	50
4200/4050	40-50	80
4200/6311	63 x 110	100

3252



MANIKOTE F/MASHKUL PN10

Kodi	Permasa	Modeli	Paketimi	Çmimi
3252/0201	20 x ½"	PN10	50 cope	150
3252/0202	20 x ¾"	PN10	50 cope	150
3252/0252	25 x ¾"	PN10	50 cope	150
3252/0253	25 x 1"	PN10	50 cope	200
3252/0322	32 x ¾"	PN10	50 cope	200
3252/0323	32 x 1"	PN10	50 cope	200

3256



MANIKOTE F/FEMER PN10

Kodi	Permasa	Modeli	Paketimi	Çmimi
3256/0201	20 x ½"	PN10	50 cope	200
3256/0202	20 x ¾"	PN10	50 cope	200
3256/0252	25 x ¾"	PN10	50 cope	200
3256/0253	25 x 1"	PN10	50 cope	220
3256/0322	32 x ¾"	PN10	50 cope	250
3256/0323	32 x 1"	PN10	50 cope	250

RAKORDE HIDRAULIKE

3262

MANIKOTE PN10

Kodi	Permasa	Modeli	Paketimi	Çmimi
3262/2020	20 x 20	PN10	50 cope	200
3262/2525	25 x 25	PN10	50 cope	250
3262/3232	32 x 32	PN10	50 cope	300



3262

MANIKOTE ME REDUKSION PN10

Kodi	Permasa	Modeli	Paketimi	Çmimi
3262/2520	25 x 20	PN10	50 cope	300
3262/3225	32 x 25	PN10	50 cope	370



3271

MANIKOTE TI PN10

Kodi	Permasa	Modeli	Paketimi	Çmimi
3671/2020	20 x 20	PN10	50 cope	250
3671/2525	25 x 25	PN10	50 cope	300
3671/3232	32 x 32	PN10		380



4672

MANIKOTE TI ME REDUKSION PN10

Kodi	Permasa	Modeli	Paketimi	Çmimi
4672/2520	20 x 20 x 20	PN10	10 cope	500
4672/3225	25 x 25 x 25	PN10	5 cope	650
4672/4032	32 x 32 x 32	PN10		750



4661/3661

MANIKOTE TI F/FEMER PN10

Kodi	Permasa	Modeli	Paketimi	Çmimi
4661/0201	20 x 1/2" x 20	PN10	20 cope	300
4661/0202	20 x 3/4" x 20	PN10	20 cope	300
4661/0252	25 x 3/4" x 25	PN10	10 cope	400
4661/0253	25 x 1" x 25	PN10	10 cope	400
3661/0322	32 x 3/4" x 32	PN10		500
3661/0323	32 x 1" x 32	PN10		500



RAKORDE HIDRAULIKE

3651



MANIKOTE TI F/MASHKULL PN10

Kodi	Permasa	Modeli	Paketimi	Çmimi
3651/0201	20 x ½" x 20	PN10	50 cope	300
3651/0202	20 x ¾" x 20	PN10	50 cope	300
3651/0203	20 x 1" x 20	PN10	50 cope	350
3651/0251	25 x ½" x 25	PN10	50 cope	350
3651/0252	25 x ¾" x 25	PN10	50 cope	350
3651/0253	25 x 1" x 25	PN10	50 cope	350
3651/0321	32 x ½" x 32	PN10		400
3651/0322	32 x ¾" x 32	PN10		400
3651/0323	32 x 1" x 32	PN10		400

3282



BRYLL F/MASHKULL PN10

Kodi	Permasa	Modeli	Paketimi	Çmimi
3282/0201	20 x ½"	PN10	50 cope	200
3282/0202	20 x ¾"	PN10	50 cope	200
3282/0251	25 x ½"	PN10	50 cope	200
3282/0252	25 x ¾"	PN10	50 cope	200
3282/0253	25 x 1"	PN10	50 cope	200
3282/0321	32 x ½"	PN10	50 cope	250
3282/0322	32 x ¾"	PN10	50 cope	250
3282/0323	32 x 1"	PN10	50 cope	250

4283/3283



BRYLL F/FEMER PN10

Kodi	Permasa	Modeli	Paketimi	Çmimi
4283/0201	20 x ½"	PN10	50 cope	250
4283/0202	20 x ¾"	PN10	50 cope	250
4283/0252	25 x ¾"	PN10	50 cope	300
4283/0253	25 x 1"	PN10	50 cope	300
3283/0322	32 x ¾"	PN10	50 cope	300
3283/0323	32 x 1"	PN10	50 cope	300

3262



BRYL PN10

Kodi	Permasa	Modeli	Paketimi	Çmimi
3299/2020	20 x 20	PN10	50 cope	250
3299/2525	25 x 25	PN10	50 cope	300
3299/3232	32 x 32	PN10		350

RAKORDE HIDRAULIKE

3251

MANIKOTE F/MASHKULL PN6

Kodi	Permasa	Modeli	Paketimi	Çmimi
3251/0201	20 x ½"	PN6	50 cope	80
3251/0202	20 x ¾"	PN6	50 cope	80
3251/0252	25 x ¾"	PN6	50 cope	120
3251/0253	25 x 1"	PN6	50 cope	120



3250

MANIKOTE F/FEMER PN6

Kodi	Permasa	Modeli	Paketimi	Çmimi
3250/0201	20 x ½"	PN6	50 cope	200
3250/0202	20 x ¾"	PN6	50 cope	200
3250/0251	25 x ½"	PN6	50 cope	250
3250/0252	25 x ¾"	PN6	50 cope	250
3250/0253	25 x 1"	PN6	50 cope	250



3261

MANIKOTE BASHKUESE PN6

Kodi	Permasa	Modeli	Paketimi	Çmimi
3261/2020	20 x 20	PN6	50 cope	150
3261/2525	25 x 25	PN6	50 cope	200



3261

MANIKOTE ME REDUKSION PN6

Kodi	Permasa	Modeli	Paketimi	Çmimi
3261/2520	25 x 20	PN6	50 cope	200
3261/3220	32 x 20	PN6	50 cope	250
3261/3225	32 x 25	PN6	50 cope	250



3291

MANIKOTE TI PN6

Kodi	Permasa	Modeli	Paketimi	Çmimi
3291/2020	20 x 20 x 20	PN6	50 cope	150
3291/2525	25 x 25 x 25	PN6	50 cope	250



RAKORDE HIDRAULIKE

3300



BRRYL PN6

Kodi	Permasa	Modeli	Paketimi	Çmimi
3300/2020	20 x 20	PN6	50 cope	150
3300/2525	25 x 25	PN6	50 cope	200

3300



BRRYL ME REDUKSION PN6

Kodi	Permasa	Modeli	Paketimi	Çmimi
3300/2520	25 x 20	PN6	50 cope	200
3300/3225	32 x 25	PN6	50 cope	350

3301



NIPEL PLASTIK

Kodi	Permasa	Paketimi	Çmimi
3301/0101	½" x ½"	100 cope	50
3301/0202	¾" x ¾"	100 cope	60
3301/0303	1" x 1"	100 cope	70
3301/0404	1¼" x 1¼"	100 cope	100
3301/0505	1½" x 1½"	10 cope	150
3301/0606	2" x 2"	10 cope	180

3302



REDUKSION PLASTIK M/MASHKULL

Kodi	Permasa	Paketimi	Çmimi
3302/0201	¾" x ½"	100 cope	50
3302/0301	1" x ½"	100 cope	60
3302/0302	1" x ¾"	100 cope	60
3302/0402	1¼" x ¾"	100 cope	100
3302/0403	1¼" x 1"	10 cope	100
3302/0405	1½" x 1¼"	10 cope	150
3302/0506	2" x 1½"	10 cope	200

3352



REDUKSION PLASTIK M/MASHKULL

Kodi	Permasa	Paketimi	Çmimi
3352/0301	1" x ½"	100 cope	70
3352/0302	1" x ¾"	100 cope	100
4352/0403	1¼" x 1"	10 cope	200
3352/0504	1½" x 1¼"	10 cope	300
3352/0604	2" x 1¼"	10 cope	350
3352/0605	2" x 1½"	10 cope	350

RAKORDE HIDRAULIKE

3351

MANIKOTE F/FEMER

Kodi	Permasa	Paketimi	Çmimi
3351/0101	½" x ½"	50 cope	80
3351/0202	¾" x ¾"	100 cope	80
3351/0303	1" x 1"	100 cope	100



3311

MANIKOTE TI PLASTIKE M/M/MASHULL

Kodi	Permasa	Paketimi	Çmimi
3311/0111	½" x ½" x ½"	100 cope	100
3311/0222	¾" x ¾" x ¾"	100 cope	200
3311/0333	1" x 1" x 1"	100 cope	250



3611

MANIKOTE TI PLASTIKE F/F/FEMER

Kodi	Permasa	Paketimi	Çmimi
3611/0111	½" x ½"	20 cope	100
3611/0222	¾" x ¾"	20 cope	200
3611/0333	1" x 1"	20 cope	250



3310

BRYLL PLSTIK M/MASHKULL

Kodi	Permasa	Paketimi	Çmimi
3310/0101	½" x ½"	100 cope	60
3310/0202	¾" x ¾"	100 cope	120
3310/0303	1" x 1"	100 cope	180



3308

BRYLL PLSTIK F/MASHKULL

Kodi	Permasa	Paketimi	Çmimi
3308/0101	½" x ½"	100 cope	100
3308/0201	¾" x ¾"	100 cope	100
3308/0202	¾" x ¾"	100 cope	120
3308/0302	1" x ¾"	100 cope	120
3308/0303	1" x 1"	100 cope	150



RAKORDE HIDRAULIKE

3610



BRRYL PLASTIK F/FEMER

Kodi	Permasa	Paketimi	Çmimi
3610/0101	½" x ½"	20 cope	100
3610/0202	¾" x ¾"	20 cope	150
3610/0303	1" x 1"	20 cope	180

3331



TAPE FUNDORE M

Kodi	Permasa	Paketimi	Çmimi
3331/0001	½"	100 cope	50
3331/0002	¾"	100 cope	80
3331/0003	1"	100 cope	100

RAKORDE HIDRAULIKE

Y270/9270



MANIKOTE LISHO PN25

Kodi	Permasa	Modeli	Paketimi	Çmimi
Y270/0020	20 x 20	PN25	10 cope	30
Y270/0025	25 x 25	PN25	10 cope	40
9270/0032	32 x 32	PN25	200 cope	80

9242



MANIKOTE ME REDUKSION PN25

Kodi	Permasa	Modeli	Paketimi	Çmimi
9242/2520	25 x 20	PN25	40 cope	45
9242/3220	32 x 20	PN25	40 cope	50
9242/3225	32 x 25	PN25	30 cope	55

Y130/9130



TI LISHO PN25

Kodi	Permasa	Modeli	Paketimi	Çmimi
Y130/0020	20 x 20 x 20 90°	PN25	10 cope	45
Y130/0025	25 x 25 x 25 90°	PN25	10 cope	55
9130/0032	32 x 32 x 32 90°	PN25	15 cope	65

RAKORDE HIDRAULIKE

Y130/9130

TI LISHO ME REDUKTIM PN25

Kodi	Permasa	Modeli	Paketimi	Çmimi
Y130/0020	25 x 20 x 25 90°	PN25	10 cope	55
Y130/0025	32 x 20 x 32 90°	PN25	15 cope	75
9130/0032	32 x 25 x 32 90°	PN25	15 cope	85



Y090/9090

BRRYL LISHO PN25

Kodi	Permasa	Modeli	Paketimi	Çmimi
Y090/0020	20 x 20 90°	PN25	10 cope	40
Y090/0025	25 x 25 90°	PN25	10 cope	55
9090/0032	32 x 32 90°	PN25	25 cope	75



9041

BRRYL LISHO PN25

Kodi	Permasa	Modeli	Paketimi	Çmimi
9041/0020	20 x 20 45°	PN25	50 cope	40
9041/0025	25 x 25 45°	PN25	50 cope	55
9041/0032	32 x 32 45°	PN25	25 cope	75



Y134/9134

TI ME FILETO MASHKULL

Kodi	Permasa	Modeli	Paketimi	Çmimi
Y134/2003	90°, 20 x 1/2" x 20	PN25	10 cope	290
9134/2504	90°, 25 x 3/4" x 25	PN25	10 cope	390
9134/3205	90°, 32 x 1" x 32	PN25	10 cope	690



Y132/9132

TI ME FILETO FEMER

Kodi	Permasa	Modeli	Paketimi	Çmimi
Y132/2003	90°, 20 x 1/2" x 20	PN25	10 cope	250
9132/2504	90°, 25 x 3/4" x 25	PN25	10 cope	350
9132/3205	90°, 32 x 1" x 32	PN25	10 cope	650



RAKORDE HIDRAULIKE

9599



SARACINESKE ME SFERE ME RUBINET TE KROMUAR

Kodi	Permasa	Çmimi
9599/0020	20 mm	990

9704



SARACINESKE ME GOMINE ME RUBINET TE KROMUAR

Kodi	Permasa	Çmimi
9704/0020	20 mm	890
9704/0032	32 mm	990

9597



SARACINESKE ME GOMINE ME KAPUÇ

Kodi	Permasa	Çmimi
9597/0020	20 mm	990

9598



SARACINESKE ME SFERE ME BISHT PLASTIK

Kodi	Permasa	Çmimi
9598/0020	20 x 20	290
9598/0025	25 x 25	450
9598/0032	32 x 32	690

Y243/9243



MANIKOTE REDUKSION PN25

Kodi	Permasa	Modeli	Paketimi	Çmimi
Y243/2520	25 x 20	PN25	10 cope	50
9243/3220	32 x 20	PN25	10 cope	80
9243/3225	32 x 25	PN25	10 cope	80

Y301/9301



TAPE ME NGJITJE FEMER PN25

Kodi	Permasa	Modeli	Paketimi	Çmimi
Y301/0020	20	PN25	10 cope	50
Y301/0025	25	PN25	10 cope	60
9301/0032	32	PN25	50 cope	70

9302/0004



TAPE E SHKURTER ME GOMINE

Kodi	Permasa	Modeli	Paketimi	Çmimi
9302/0004	3/4"	PN25	10 cope	50

RAKORDE HIDRAULIKE

9285

KALESE LISHO PN20

Kodi	Permasa	Modeli	Paketimi	Çmimi
9285/0020	20	PN20	15 cope	100
9285/0025	25	PN20	10 cope	150
9285/0032	32	PN20	5 cope	290



Y093/9093

BRRYL F/MASHKULL PN25

Kodi	Permasa	Modeli	Paketimi	Çmimi
Y093/2003	90°, 20 x ½"	PN25	10 cope	250
9093/2504	90°, 25 x ¾"	PN25	10 cope	390
9093/3205	90°, 32 x 1"	PN25	10 cope	590



Y091/9091

BRRYL F/FEMER PN25

Kodi	Permasa	Modeli	Paketimi	Çmimi
Y091/2003	90°, 20 x ½"	PN25	10 cope	190
9091/2504	90°, 25 x ¾"	PN25	10 cope	290
9091/3205	90°, 32 x 1"	PN25	15 cope	590



Y271/9271

MANIKOTE FEMER

Kodi	Permasa	Modeli	Paketimi	Çmimi
Y271/2003	90°, 20 x ½"	PN25	10 cope	175
9271/2504	90°, 25 x ¾"	PN25	10 cope	290
9271/3205	90°, 32 x 1"	PN25	10 cope	590



Y244/9244

MANIKOTE M/FEMER

Kodi	Permasa	Modeli	Paketimi	Çmimi
Y244/2003	90°, 20 x ½"	PN25	10 cope	290
9244/2504	90°, 25 x ¾"	PN25	20 cope	490
9244/3205	90°, 32 x 1"	PN25	10 cope	690



9181

BRRYL ÇIFT

Kodi	Permasa	Modeli	Çmimi
9181/2003	20 x ½"	PN25	490



102000



Tub shkarkimi

Kodi	Permasa	Gjatesia	Çmimi
10200001	Ø 32	0.25 m	100
10200002	Ø 32	0.5 m	150
10200004	Ø 32	1 m	190
10200006	Ø 32	2 m	350
10200007	Ø 32	3 m	550

102000



Tub shkarkimi

Kodi	Permasa	Gjatesia	Çmimi
10200021	Ø 40	0.25 m	100
10200022	Ø 40	0.5 m	150
10200024	Ø 40	1 m	250
10200026	Ø 40	2 m	450
10200027	Ø 40	3 m	590

102000



Tub shkarkimi

Kodi	Permasa	Gjatesia	Çmimi
10200041	Ø 50	0.25 m	100
10200042	Ø 50	0.5 m	190
10200044	Ø 50	1 m	250
10200046	Ø 50	2 m	450
10200047	Ø 50	3 m SDR 42	650

102001



Tub shkarkimi

Kodi	Permasa	Gjatesia	Çmimi
10200101	Ø 75	0.25 m	190
10200102	Ø 75	0.5 m	290
10200104	Ø 75	1 m	390
10200106	Ø 75	2 m	750
10200107	Ø 75	3 m	990

102001



Tub shkarkimi

Kodi	Permasa	Gjatesia	Çmimi
10200151	Ø 90	0.25 m	250
10200152	Ø 90	0.5 m	350
10200154	Ø 90	1 m	590
10200156	Ø 90	2 m	990
10200158	Ø 90	3 m	1.450

102002

Tub shkarkimi

Kodi	Permasa	Gjatesia	Çmimi
10200201	Ø 110	0.25 m	250
10200215	Ø 110	0.5 m	390
10200204	Ø 110	1 m	690
10200206	Ø 110	2 m	1.250
10200207	Ø 110	3 m	1.750



102002

Tub shkarkimi

Kodi	Permasa	Gjatesia	Çmimi
10200221	Ø 125	0.25 m	350
10200235	Ø 125	0.5 m	750
10200224	Ø 125	1 m	950
10200226	Ø 125	2 m	1.750
10200227	Ø 125	3 m	2.490



102015

Ypsilon me 2 dalje

Kodi	Permasa	Lloji	Çmimi
10201505	Ø 50 Ø 50 Ø 50	45° gri	290
10201538	Ø 50 Ø 110 Ø 50	45° gri	590
10201544	Ø 110 Ø 110 Ø 110	45° gri	650



102990

Pilete Inoksi

Kodi	Permasa	Lloji	Çmimi
10299000	Ø 50 H	150x150 gri	390
10299002	Ø 75 H	150x150 gri	450



102990

Pilete Inoksi

Kodi	Permasa	Lloji	Çmimi
10299001	Ø 50 V	150x150 gri	390
10299003	Ø 75 V	200x200 gri	750



102003



Brryl me gomine

Kodi	Permasa	Lloji	Çmimi
10200300	Ø 32	15° gri	50
10200301	Ø 40	15° gri	70
10200302	Ø 50	15° gri	90
10200304	Ø 75	15° gri	150
10200329	Ø 90	15° gri	170
10200308	Ø 110	15° gri	190
10200309	Ø 125	15° gri	350

102005



Brryl me gomine

Kodi	Permasa	Lloji	Çmimi
10200500	Ø 32	30° gri	50
10200501	Ø 40	30° gri	70
10200502	Ø 50	30° gri	90
10200504	Ø 75	30° gri	150
10200529	Ø 90	30° gri	170
10200508	Ø 110	30° gri	190
10200509	Ø 125	30° gri	350
10200510	Ø 160	30° gri	590

102006



Brryl me gomine

Kodi	Permasa	Lloji	Çmimi
10200600	Ø 32	45° gri	50
10200601	Ø 40	45° gri	70
10200602	Ø 50	45° gri	90
10200604	Ø 75	45° gri	150
10200611	Ø 90	45° gri	170
10200608	Ø 110	45° gri	190
10200609	Ø 125	45° gri	350
10200610	Ø 160	45° gri	590

102008



Brryl me gomine

Kodi	Permasa	Lloji	Çmimi
10200800	Ø 32	90° gri	50
10200801	Ø 40	90° gri	70
10200802	Ø 50	90° gri	90
10200804	Ø 75	90° gri	150
10200811	Ø 90	90° gri	170
10200808	Ø 110	90° gri	190
10200809	Ø 125	90° gri	350
10200810	Ø 160	90° gri	590

102009

Ypsilon me gomine

Kodi	Permasa	Lloji	Çmimi
10200900	Ø 32	45° gri	100
10200901	Ø 32	45° gri	120
10200902	Ø 40	45° gri	130
10200903	Ø 50	45° gri	140
10200904	Ø 50	45° gri	150
10200905	Ø 50	45° gri	120
10200912	Ø 75	45° gri	170
10200914	Ø 75	45° gri	250
10200938	Ø 110	45° gri	290
10200940	Ø 110	45° gri	350
10200944	Ø 110	45° gri	390
10200953	Ø 125	45° gri	590
10200954	Ø 125	45° gri	690
10200963	Ø 160	45° gri	850
10200964	Ø 160	45° gri	990
10200965	Ø 160	45° gri	1.100



102011

Tl me gomine

Kodi	Permasa	Lloji	Çmimi
10201100	Ø 32 Ø 32	90° gri	90
10201101	Ø 40 Ø 32	90° gri	120
10201102	Ø 40 Ø 40	90° gri	150
10201103	Ø 50 Ø 32	90° gri	160
10201104	Ø 50 Ø 40	90° gri	180
10201105	Ø 50 Ø 50	90° gri	150
10201112	Ø 50 Ø 50	90° gri	160
10201114	Ø 75 Ø 75	90° gri	220
10201138	Ø 110 Ø 50	90° gri	290
10201140	Ø 110 Ø 75	90° gri	350
10201144	Ø 110 Ø 110	90° gri	390
10201153	Ø 125 Ø 110	90° gri	550
10201154	Ø 125 Ø 125	90° gri	650
10201163	Ø 125 Ø 125	90° gri	890
10201164	Ø 160 Ø 125	90° gri	950
10201165	Ø 160 Ø 160	90° gri	990



102014

Tl me gomine

Kodi	Permasa	Lloji	Çmimi
10201402	Ø 50	Me tape fundore	250
10201404	Ø 75	Me tape fundore	350
10201408	Ø 110	Me tape fundore	490
10201409	Ø 125	Me tape fundore	590



102012



Reduksion gote

Kodi	Permasa	Ngjyra	Çmimi
10201200	Ø 40 Ø 32	gri	80
10201202	Ø 50 Ø 40	gri	100
10201208	Ø 75 Ø 50	gri	120
10201230	Ø 110 Ø 50	gri	150
10201232	Ø 110 Ø 75	gri	160
10201253	Ø 160 Ø 110	gri	390
10201254	Ø 160 Ø 125	gri	450

102022



Tape fundore me gomine

Kodi	Permasa	Ngjyra	Çmimi
10202200	Ø 32	gri	30
10202201	Ø 40	gri	30
10202202	Ø 50	gri	30
10202204	Ø 75	gri	60
10202208	Ø 110	gri	80
10202209	Ø 125	gri	150
10202210	Ø 160	gri	220

102023



Manikote me gomine

Kodi	Permasa	Ngjyra	Çmimi
10202300	Ø 32	gri	130
10202301	Ø 40	gri	130
10202302	Ø 50	gri	130
10202304	Ø 75	gri	250
10202339	Ø 90	gri	250
10202308	Ø 110	gri	290
10202309	Ø 125	gri	490

100237



Saracineske

Kodi	Permasa	Ngjyra	Çmimi
10023700	Ø 20	gri	990
10023701	Ø 25	gri	1.500
10023702	Ø 32	gri	1.550
10023703	Ø 40	gri	2.500
10023704	Ø 50	gri	2.900
10023705	Ø 63	gri	4.500



PRODUKTE FAMILJARE

DHE OUTDOOR

Dryn bronzi me kombinim



Kodi	Permasa	Çmimi
BLK1030	28 mm	790
BLK1032	38 mm	990

Dryn bronzi i gjate me 3 celsa



Kodi	Permasa	Çmimi
BLK1010	30 mm	590
BLK1012	40 mm	790
BLK1014	50 mm	1.290
BLK1016	60 mm	1.890

FISHEK BRAVE SATIN



Kodi	Permasa	Çmimi
BLK1070	54 (27/27) mm	890
BLK1072	60 (30/30) mm	900
BLK1074	65 (35/35) mm	950
BLK1076	70 (30/40) mm	990
BLK1078	75 (30/45) mm	1.100
BLK1080	80 (40/40) mm	1.150
BLK1082	80 (30/50) mm	1.150
BLK1084	90 (30/60) mm	1.250
BLK1085	90 (40/50) mm	1.250

FISHEK BRAVE BRONZI



Kodi	Permasa	Çmimi
BLK1050	54 (27/27) mm	850
BLK1052	60 (30/30) mm	850
BLK1054	65 (35/35) mm	890
BLK1055	70 (30/40) mm	950
BLK1056	75 (30/45) mm	990
BLK1057	80 (40/40) mm	1.100
BLK1058	80 (30/50) mm	1.100
BLK1059	90 (30/60) mm	1.150
BLK1060	90 (40/50) mm	1.150

Celes per dryn

BLK1092

- BLK1100



Çmimi
95

Celes reserve per fishek

BLK1090

- BLK1050 - BLK1085



Çmimi
120

FISHEK BRAVE BRONZI ME 3 CELESA



Kodi	Permasa A B C D	Çmimi
B68	68 / 26 - 10 - 32 mm	950
B68V	68 / 26 - 10 - 32 mm (Blister)	990

FISHEK BRAVE SATIN

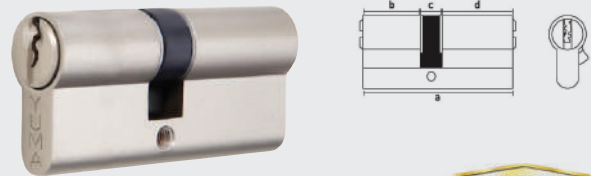

Kodi	Permasa A B C D	Çmimi
B62S	62 / 26 - 10 - 26 mm	890
B68S	68 / 26 - 10 - 32 mm	950
B83S	83 / 33 - 10 - 40 mm	1.290

FISHEK BRAVE SATIN

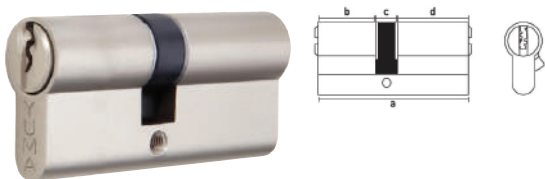

Kodi	Permasa A B C D	Çmimi
B90S	90 / 35 - 10 - 45 mm	1.390
B100S	100 / 40 - 10 - 50 mm	1.490

FISHEK BRAVE BRONZI ME 3 CELESA

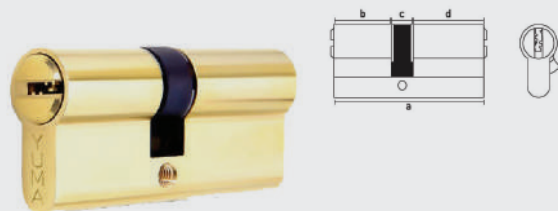

Kodi	Permasa A B C D	Çmimi
B68B	68 / 26 - 10 - 32 mm (Blister)	1.100
B68BT	68 / 26 - 10 - 32 mm (Me Bllokues)	1.190

FISHEK BRAVE SATIN ME 3 CELESA



Kodi	Permasa	Çmimi
B68BS	68 / 26 - 10 - 32 mm (Blister)	1.100
B68BTS	68 / 26 - 10 - 32 mm (Me Bllokues)	1.190
B68B2TS	100 / 40 - 10 - 50 mm (Me 2 Bllokues)	1.250

FISHEK BRAVE SATIN GJYSEM ME 2 CELESA

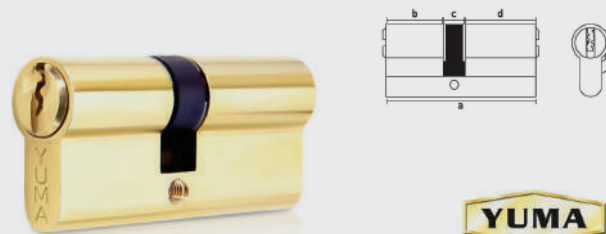

Kodi	Permasa A B C D	Çmimi
B41S	41 / 26 - 10 - 5 mm	690
B55S	55 / 40 - 10 - 5 mm	850

FISHEK BRAVE BRONZI KOMPJUTERIK ME 3 CELESA



Kodi	Permasa	Çmimi
B68BK	68 mm bronzi	990
B68BTK	68 mm bronzi (Me Bllokues)	1.100

FISHEK BRAVE SATIN KOMPJUTERIK ME 3 CELESA



Kodi	Permasa	Çmimi
B68BSK	68 mm nikeli	900
B68BTSK	68 mm nikeli (Me Bllokues)	1.100
B90BS	90 mm nikeli	1.590



FISHEK BRAVE ME LEVE ME 3 CELESA



Kodi	Permasa	Çmimi
B41MS	41 mm(Satin)	790
B68MK	68 mm(Bronz)	990
B68MSK	68 mm (Satin)	990
B90MSK	90 mm (Satin Kompjuterik)	1.490

FISHEK BRAVE KOMPJUTERIK ME LEVE ME 3 CELESA



Kodi	Permasa	Çmimi
B68BMK	68 mm(Bronzi)	1.100
B68BMSK	68 mm (Satin)	1.100
B68BTMK	68 mm (Bronzi me bllokues)	1.200
B68BTMSK	68 mm (Satin me bllokues)	1.200
B90BMSK	90 mm (Satin)	1.690

FISHEK BRAVE, 3 CELESA ME NGJYRA ME 6 KUNJA



Kodi	Permasa	Çmimi
B68BNP6	68 mm	1.490
B68BMNP6	68 mm(Kompjuterik)	1.690

BRAVE QEPENI ME 2 CELESA



Kodi	Permasa	Çmimi
600.ak	14 cm (oval e zeze)	1.250
601.ak	12 cm (oval e zeze)	1.250
602.ak	14 cm (katrore e zeze)	1.250
600.3m.ak	14 cm (oval e zeze me 3 fisheke)	1.250

DOREZE DERE TUALETI



Kodi	Permasa	Çmimi
709-A	Kunje dyersh kabine dushi	890
709-K	Shul dyersh kabine dushi	790
709-M	Menteshe kabine dushi	650

KOKE FISHEKU ME CELESA



Kodi	Materiali	Çmimi
608	Bronzi	650

ROZETE NE FORME CELESI M5



Kodi	Permasa	Çmimi
721	Klasike	300
722	Rrethore	450
723	Katrore	450

SHENJUES METALI ME KOKE



Kodi	Permasa	Çmimi
790S	I zi / rrumbullake	79
790M	Blu / rrumbullake	79
790K	I kuq / rrumbullake	79
791S	I zi / katrore	79
791M	Blu / katrore	79
791K	I kuq / katrore	79

BRAVE DYERSH ALUMINI



Kodi	Permasa	Çmimi
SD20	20 mm	750
SD25	25 mm	750
SD35	35 mm	690
SD40	40 mm	790
SD45	45 mm	790

BRAVE DYERSH ME 3 KUNJA SIGURIE



890
SD45.3M

Permasa

45 mm

BRAVE DYERSH ME FISHEK SATIN ME 3 CELESA



Kodi	Permasa	Çmimi
635	35 mm	1.590
640	40 mm	1.590
645	45 mm	1.590

BRAVE DYERSH ME 3 KUNJA SIGURIE DHE FISHEK SATIN



180
645C.3M

Permasa

35 mm

BRAVE DYERSH TE BRENDSHME SATIN



Kodi	Permasa	Çmimi
604	35 mm	690
613	40 mm	750
614	45 mm	750

BRAVE DYERSH TUALETI SATIN



Kodi	Permasa	Çmimi
607	40 mm	690
615	45 mm	750

MEKANIZEM HIDRAULIK PER DYER



Kodi	Permasa	Çmimi
YM-712	25 - 45 kg	1.690
YM-713	40 - 60 kg	2.290
YM-714	60 - 85 kg	2.990
YM-715	80 - 100 kg	4.500

MEKANIZEM HIDRAULIK ECO PER DYER



Kodi	Çmimi
YMK-742	1.590
YMK-743	1.690
YMK-744	2.390

PISTON SIGURIE MEKANIK

1.100

729



Per dyer

mekanike

DOREZ MEKANIKE ME MBAJTSE GOME TE ZEZE

2.290

716



Per dyer

mekanike

SHUL DYERSH



Kodi	Materiali	Çmimi
701	Bronzi	590
702	Nikel	590

SHUL DYERSH ME DOREZE



	Ngjyra	Çmimi
724	E bardhe	190
724K	Kafe	220
724D	E bardhe (Me Buton)	250
724KD	Kafe (Me Buton)	290

SET FISHEKE BRAVE ME 2 CELESA



Kodi	Permasa	Çmimi
725	Katror prej celiku	2.550
745	Me celes per sirtare	3.650

KYC SIRTARI ME 2 CELESA



Kodi	Permasa	Çmimi
YMK-708 - K	Katrore	90
YMK-708 - O	Ovale	120
YMK-708 - M	Me kunj sigurie	135

KAVO BICIKLETE ME DRYN DHE 3 CELESA



Kodi	Permasa	Çmimi
736	10mm x 170cm e kompletuar	6.490
Z-1	10mm x 170cm vetem zinxhir	4.950

KAVO BICIKLETE ME DRYN DHE 3 CELESA



Kodi	Permasa	Çmimi
737	10mm x 170cm e kompletuar celiku	4.890
Z-2	10mm x 170cm vetem zinxhir celiku	3.790

DRYN QEPENI



Kodi	Permase	Çmimi
YM-1060R	60 mm	790
YM-1070R	70 mm	890
YM-1080R	80 mm	950
YM-1090R	90 mm	990

DRYN NIKELI PER QEPENA



Kodi	Permase	Çmimi
YMK-1260R	60 mm	590
YMK-1270R	70 mm	690
YMK-1280R	80 mm	750
YMK-1290R	90 mm	850

DRYN BRONZI PER QEPENQEPENI ME RRESHQITJE AUTOMATIKE



Kodi	Permase	Çmimi
3070	70 mm	1.900
3080	80 mm	2.090

DRYN BRONZI PER QEPENQEPENI ME RRESHQITJE MANUALE



Kodi	Permase	Çmimi
3068	70 mm	1.690
3079	80 mm	1.850

DRYN HEKURI I VERDHE



Kodi	Permase	Çmimi
YM-1025B	25 mm	150
YM-1032B	32 mm	190
YM-1038B	40 mm	250
YM-1050B	50 mm	450
YM-1063B	63 mm	590

DRYN HEKURI I VERDHE I LYER



Kodi	Permase	Çmimi
YMK-1220B	20 mm	90
YMK-1225B	25 mm	100
YMK-1232B	32 mm	130
YMK-1238B	40 mm	160
YMK-1250B	50 mm	250
YMK-1263B	63 mm	350

DRYN BRONZI STANDART



Kodi	Permase	Çmimi
2032	32 mm	690
2040	40 mm	850
2050	50 mm	1.150
2060	60 mm	1.490

DRYN BRONZI I GJATE



Kodi	Permase	Çmimi
2032L	32 mm	790
2040L	40 mm	950
2050L	50 mm	1.290
2060L	60 mm	1.690



DRYN BRONZI ME KOMBINIM



Kodi	Permasa	Çmimi
YM-2120	20 mm	550
YM-2125	25 mm	590
YM-2130	30 mm	750
YM-2140	40 mm	1.100
YM-2150	50 mm	1.900

DRYN HEKURI ME KOMBINIM YMK



Kodi	Permasa	Çmimi
YMK-1325	25 mm	220
YMK-1332	32 mm	250
YMK-1338	38 mm	290
YMK-1350	50 mm	350

DRYN BRONZI I VERDHE I GJATE



Kodi	Permasa	Çmimi
YM-1032BL	32 mm	200
YM-1038BL	38 mm	260
YM-1050BL	50 mm	450

DRYN BRONZI I VERDHE I GJATE



Kodi	Permasa	Çmimi
YMK-1225BL	25 mm	100
YMK-1232BL	32 mm	150
YMK-1238BL	40 mm	170
YMK-1250BL	50 mm	250
YMK-1263BL	63 mm	390

DRYN HEKURI GRI I GJATE



Kodi	Permasa	Çmimi
YM-1032L	32 mm	190
YM-1038L	38 mm	250
YM-1050L	50 mm	450

DRYN HEKURI I GJATE



Kodi	Permasa	Çmimi
YMK-1225L	25 mm	100
YMK-1232L	32 mm	120
YMK-1238L	40 mm	150
YMK-1250L	50 mm	250
YMK-1263L	63 mm	330

DRYN HEKURI GRI



Kodi	Permasa	Çmimi
YM-1020	20 mm	150
YM-1025	25 mm	170
YM-1032	32 mm	190
YM-1038	40 mm	250
YM-1050	50 mm	390
YM-1063	43 mm	590

DRYN HEKURI



Kodi	Permasa	Çmimi
YMK-1220	20 mm	85
YMK-1225	25 mm	100
YMK-1232	32 mm	120
YMK-1238	40 mm	150
YMK-1250	50 mm	220
YMK-1263	63 mm	330

DRYN BRONZI PROFI ME 3 ÇELESA



Kodi	Permasa	Çmimi
DBPL0202	20 mm	250
DBPL0302	30 mm	540
DBPL0402	40 mm	690
DBPL0502	50 mm	990
DBPL0602	60 mm	1.290
DBPL0702	70 mm	1.390

DRYN HEKURI ME 3 ÇELESA



Kodi	Permasa	Çmimi
DIPL0301	32 mm	190
DIPL0401	38 mm	250
DIPL0501	50 mm	350
DIPL0601	63 mm	490
DIPL0701	75 mm	690

DRYN BRONXI ME 3 ÇELESA



Kodi	Permasa	Çmimi
DBBPL0602	60 mm	1.250
DBBPL0702	70 mm	1.590
DBBPL0802	80 mm	1.990
DBBPL0902	90 mm	2.350

DRYN HEKURI PROFI ME CELESA DHE KUNDER UJIT



450

WPD9455

Permasa

55 mm

DRYN BRONZI ME 3 CELESA



Kodi	Permasa	Çmimi
WPD1420	20 mm	190
WPD1440	40 mm	390
WPD1460	60 mm	790

DRYN BRONZI ME QAFE TE GJATE ME 3 CELESA



650

WPD2450

Permasa

50 mm

DRYN BRONZI ME 3 KODE



330

WPD3423

Permasa

3 x 20 mm

DRYN CELIKU ME 3 CELESA



490

WPD450

Permasa

50 mm

KAVO BIKIKLETE ME KOD 4-SHIFROR

690

DBK21012



Permasa

10 x 1200 mm

KAVO BIKIKLETE ME 2 ÇELESA



Kodi	Permasa	Çmimi
DBK11010	10 x 1000 m	690
DBK11210	12 x 1000 m	790

KAVO BIKIKLETE ME 2 ÇELESA

850

DBK151201



Permasa

15 X 1200 mm

KAVO BIKIKLETE ME 2 ÇELESA

1.350

DBK112012



Permasa

20 x 1200 mm

KAVO BIKIKLETE ME KOD 4 SHIFROR

390

WBK2108



Permasa

8 x 1000 mm

KAVO BIKIKLETE ME KOD 4 SHIFROR

490

WBK2110



Permasa

10 x 1200 mm

KAVO BIKIKLETE ME 2 CELESA

450

WBK1112



Permasa

12 x 1200 mm

KAVO BIKIKLETE I SPERDREDHUR ME 2 CELESA

690

WBK5108



Permasa

18 x 800 mm

**KAVO BIKIKLETE ZINXHIR
ME 2 CELESA**

5.3x900mm

790
WBK4109



Permasa

5.3 x 900 mm

KAVO BIKIKLETE U ME 2 CELESA

200x250mm

890
WBK6125



Permasa

200 x 250 mm

Dryn bronzi



77700



Çmimi
290

Kavo biciklete me celes sigurie



77830

Gjatesia 8 mm x 65 cm



Çmimi
650

Kavo biciklete me kod sigurie



77831

Gjatesia 8 mm x 65 cm



Çmimi
490

Kavo biciklete me celes sigurie



77840

Gjatesia 12 mm x 1.8 m



Çmimi
890

Kavo biciklete me kod sigurie



77845

Gjatesia 10 mm x 1.2 m



Çmimi
890

Kavo biciklete me celes sigurie



77850

Gjatesia 18 mm x 100 cm



Çmimi
950

Kavo motori me celes sigurie

77861

Gjatesia 25 mm x 150 cm

 Çmimi
1.690
Zinxhir sigurie për dyer

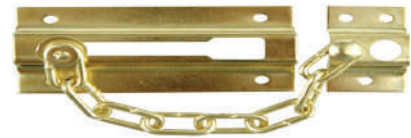
77900

 Çmimi
290
Kuti celesash metalike e bardhe

78432

Permasa 200x160x78 mm

 Çmimi
1.900
Litar elastik për bagazhe dysh

Kodi	Gjatesia [cm]	Çmimi
83208	80	250
83210	100	290
82315	150	350
82320	200	450

Kandar metalik 32 kg

15301

 Çmimi
390
Kandar metalik 25 kg

15291

 Çmimi
350
Etiketa mbajttese celesi 12 cope

77930

 Çmimi
190
Makineri Skocimi 50 mm

75295

 Çmimi
890

Kuti celesash murale me kombinim BORMANN

BDS2000

- Permasa: 8.7x4x12.2 cm (10 cope)



Çmimi
2.490

Kasaforte Dixhitale BORMANN

BDS2300

- Kuti dixhitale me bllokim elektrik dhe celes
- Dimensionet: 23x17x17 cm
- E sigurte per hotele dhe shtepi



Çmimi
4.900

Kasaforte Dixhitale BORMANN

BDS3000

- Kuti dixhitale me celes
- Dimensionet: 31x20x20 cm
- E sigurte per hotele dhe shtepi



Çmimi
5.900

Kasaforte Dixhitale BORMANN

BDS6000

- Kuti dixhitale me bllokim elektrik dhe celes
- Dimensionet: 43x38x20 cm
- E sigurte per hotele dhe shtepi



Çmimi
9.500

KASAFORTE DIXHITALE



11L

4.900
ESF2002

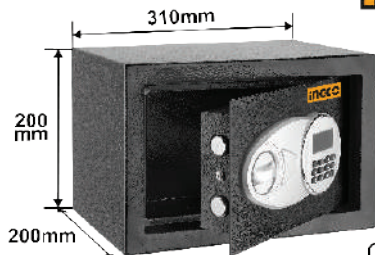

Vellimi
Permasa

11 Lt
20x31x20 cm

KASAFORTE DIXHITALE



19L

6.500
ESF2502

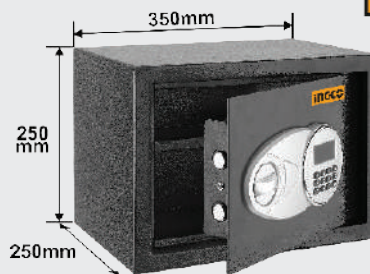

Vellimi
Permasa

19 Lt
25x35x25 cm

KASAFORTE DIXHITALE



27L

8.500
ESF3502

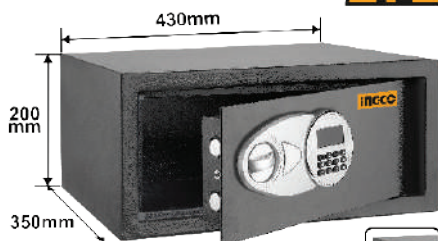

Vellimi
Permasa

27 Lt
20x43x35 cm

KASAFORTE DIXHITALE



52L

9.900
ESF5002

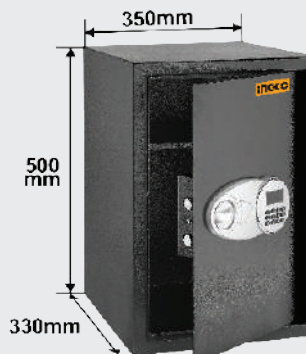

Vellimi
Permasa

52 Lt
50x35x33 cm

Kuti postare e zeze



BMB1003

- Permasat: 300x200x50 mm



Çmimi
1.790

Kuti postare gri



BMB1001

- Permasat: 300x200x50 mm



Çmimi
1.690

Kuti Postare Gri



78541

285 x 200 x 60 mm



Çmimi
1.590

Kuti Postare e Zeze



78555

- 360 x 260 x 80 mm



Çmimi
1.990

Kuti per ndihmen e shpejte



BFB2000

- Dimensionet: 32 x 22 x 8 cm
- Ngjyra e bardhë



Çmimi
2.990

Mbajtese monitori 13"-27"



BTV1500

- Koke e levizshme
- Me bazament



Çmimi
1.690

Mbajtese muri per TV 26-55



BTV1200

- Me profil 49 mm
- Kapacitet mbajtje 45 Kg



Çmimi
1.950

Mbajtese muri per TV 13-42



BTV1050

- Me profil 40-375 mm

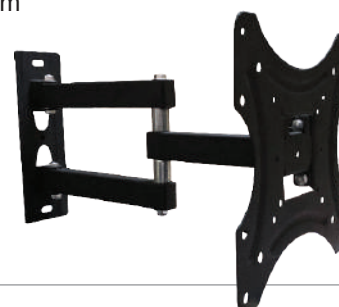

Çmimi
1.990

Mbajtese muri per TV 26-55



BTV1100

- Me profil 60-475 mm



Çmimi
3.900

Mbajtese televizori e levizshme



BTV1300

- Permasat: 26-60 "
- Kapaciteti: 50 kg



Çmimi
9.900

Peshore elektronike



69204

- Kapaciteti deri ne 180 kg



Çmimi
1.690

Peshore elektronike me bluetooth



69205

- Kapaciteti deri ne 180 kg



Çmimi
1.490

Hekur rrobash 2800 W, 320 ml



68115



Çmimi
3.900

Pastruese dyshemje me bateri



23.520.40

- Fuqia: 18 V
- Depozita: 20 L
- Kapaciteti: 1800m²/h
- Pesha: 10.3 Kg
- (Vetem trup)



Çmimi
29.900

Pastrues xhamash me bateri



34.371.00

- Fuqia: 18 V
- Depozita: 10 L
- Me avull brillianto
- Pa karbonica (Vetem trup)



Çmimi
5.900

Fshese dore me bateri



23.471.80

- Fuqia: 18 V
- Depozita: 0.6 L
- 2 ne 1 TE-SV
- (Vetem trup)



Çmimi
14.900

Blender elektrik per smoothie

LUND

67703



Çmimi
4.990

Ngrohës uji elektrik me xham

LUND

68173

Fuqia: 2.200W
Depozite: 1.7 Lt



Çmimi
3.990

Toster me pjata

BORMANN

BHA3300

- Fuqia: 2000 W
- Pjata: 30x24 cm



Çmimi
6.500

Furnelle elektrike, 2 pllaka qermike

BORMANN

BEP3200

- Fuqia: 2500 W
- Permasa: 185x155 mm



Çmimi
5.200

Sobe elektrike me furre dhe pllaka

BORMANN

BEP4010

- Fuqia: 3700 W
- 2 pllaka Titanium



Çmimi
12.500

Shtyrdhësë agrumesh profesionale

BORMANN

BFJ2000



Çmimi
6.600

Brumatrice TITANIUM

BORMANN

BHA1900

- Fuqia: 1300W
- Depozite inoxi: 5 L
- 6 nivele shpejtesie



Çmimi
12.500

Grirese elektrike mishi dhe perimesh

BORMANN

BHA1820

- Fuqia: 2000 W



Çmimi
15.900

CORDLESS
Kitchen Appliance



Blender me bateri

KEJB052R

- Fuqia: 300 W
- Tensioni i baterisë: 16 V
- Bateria: 2000 mAh
- Kapaciteti: 1.5 Lt
- 2 nivele shpejtësie
- 4 tehe inoksi, enë qelqi
- Ekran LED, 1 bateri 2.0Ah, 1 karikues



Çmimi
6.590

E RE

CORDLESS
Kitchen Appliance

Blender me bateri

KMJB047R

- Fuqia: 100 W
- Tensioni i baterisë: 16 V
- Bateria: 2000 mAh
- 5 nivele shpejtësie
- 2 tehe inoksi, Ekran LED
- Shufra e përzierjes SUS, vetëm trup



Çmimi
2.890

E RE

CORDLESS
Kitchen Appliance

Set blender me bateri 5 në 1

KEJB056R

- Fuqia: 100 W
- Tensioni i baterisë: 16 V
- Bateria: 2000 mAh
- 2 tehe inoksi
- Enë për copëtim 500 ml
- 1 rrahëse, 1 gotë matëse, shkumues qumështi
- Ekran LED, 1 bateri 2.0Ah, 1 karikues



Çmimi
7.490

E RE

CORDLESS
Kitchen Appliance

Mikser me bateri

KEMX023R

- Fuqia: 100 W
- Tensioni i baterisë: 16 V
- Bateria: 2000 mAh
- 7 nivele shpejtësie
- 2 tehe inoksi, 2 rrahëse
- 1 shkumues qumështi
- 1 bateri 2.0Ah, 1 karikues



Çmimi
6.900

E RE

CORDLESS
Kitchen Appliance

Përpunues ushqimi me bateri

KEMG027R

- Fuqia: 250 W
- Tensioni i baterisë: 16 V
- Bateria: 2000 mAh
- 3 funksione, kapaciteti 1.25 L
- 2 thika për prerje dhe copëtim
- Nivelet e funksionimit: P-0-1-2
- 1 teh prerës, 1 teh rrahje, 1 bateri 2.0Ah, 1 karikues



Çmimi
6.900

E RE

CORDLESS
Kitchen Appliance

Karikues baterie

HEDC006B

- Tensioni i hyrjes: 220-240 V
- Tensioni i daljes: 16 V
- Rryma 1.3 A



Çmimi
790

E RE

CORDLESS
Kitchen Appliance

Bateri Lithium

HMDC005S

- Tensioni i baterisë: 16 V
- Bateria Litium: 2Ah
- I përshtatshëm për të gjitha produktet e serisë 16V



Çmimi
1.900

E RE

CORDLESS
Kitchen Appliance

Set blender me bateri 5 në 1

KMJB042L

- Fuqia: 60 W
- Tensioni i baterisë: 7.4 V
- Bateria: 1500 mAh
- 2 tehe inoksi
- Enë për copëtim 500 ml
- 1 rrahëse, 1 gotë matëse
- Shkumues qumështi



Çmimi
4.500

E RE

CORDLESS
Kitchen Appliance

Blender me bateri

KMJB022L

- Fuqia: 120 W
- Tensioni i baterisë: 7.4 V
- Bateria: 2000 mAh
- Kapaciteti: 500 mL
- Enë kundër rrëshqitjes
- 4 tehe inoksi
- Karikues me fishë USB



Çmimi
4.500

CORDLESS
Kitchen Appliance

decaLife

Copëzues ushqimi me bateri

KMMG008B

- Fuqia: 30 W
- Tensioni i baterisë: 3.7 V
- Bateria: 1500 mAh
- Kapaciteti: 300 mL
- Enë qelqi 300 ml
- 3 tehe inoksi
- Karikues me fishë USB



Çmimi
1.990

CORDLESS
Kitchen Appliance

decaLife

Mikser dore me bateri

KMMX018G

- Fuqia: 25 W
- Tensioni i baterisë: 3.7 V
- Bateria: 1500 mAh
- 3 nivele shpejtësie
- 2 rrahëse inoksi
- Karikues me fishë USB



Çmimi
1.590

CORDLESS
Kitchen Appliance

decaDeal

Mikser dore me bateri

KMMX019G

- Fuqia: 25 W
- Tensioni i baterisë: 3.7 V
- Bateria: 1500 mAh
- 3 nivele shpejtësie
- 2 rrahëse inoksi
- Enë qelqi për copëtim 0.3 L
- Karikues me fishë USB



Çmimi
1.990

CORDLESS
Kitchen Appliance

decaDeal

Blender portabël me bateri

KMJB035G

- Fuqia: 30 W
- Tensioni i baterisë: 3.7 V
- Bateria: 1500 mAh
- Kapaciteti: 300 ml
- 3 nivele shpejtësie
- 2 tehe inoksi
- Karikues me fishë USB



Çmimi
1.590

CORDLESS
Kitchen Appliance

decaDeal

Blender portabël me bateri

KMJB035W

- Fuqia: 30 W
- Tensioni i baterisë: 3.7 V
- Bateria: 1500 mAh
- Kapaciteti: 300 ml
- 3 nivele shpejtësie
- 2 tehe inoksi
- Karikues me fishë USB



Çmimi
1.590

CORDLESS
Kitchen Appliance

decaDeal

Përpunues ushqimi me bateri

KMMG005B

- Fuqia: 200 W
- Tensioni i baterisë: 11.1 V
- Bateria: 2000 mAh
- 3 funksione
- 2 thika inoksi
- Nivelet e funksionimit: P-0-1-2
- Pastrim i lehtë thike



Çmimi
5.900

CORDLESS
Kitchen Appliance

decaPrime

Set Blender 4 në 1

KMJB024B

- Fuqia: 100 W
- Tensioni i baterisë: 11.1 V
- Bateria: 2000 mAh
- 2 thika inoksi
- Bateria: 2000 mAh
- 1 rrahëse, 1 gotë matëse
- Shkumues qumështi



Çmimi
4.900

CORDLESS
Kitchen Appliance

decaPrime

Mikser me bateri

KMMX006B

- Fuqia: 90 W
- Tensioni i baterisë: 11.1 V
- Bateria: 2000 mAh
- 7 nivele shpejtësie
- 2 rrahëse
- 2 përzjerëse
- Shkumues qumështi



Çmimi
5.900

decaPrime

E RE

CORDLESS
Kitchen Appliance

Fshesë portative me bateri

CMPV003W

- Fuqia: 90 W
- Bateria: 11.1 V
- Motorr pa karbonçina
- Koha e karikimit: 4 orë
- Me kablllo karikimi USB



Çmimi
5.900

decalife

CORDLESS
Kitchen Appliance

CMPV003B

Fshesë portabël me bateri

CUCV001W

- Fuqia: 140 W
- Bateria: 22.2 V
- Kapaciteti: 0.8 L
- Koha e karikimit: 4 orë
- Filtër HEPA



Çmimi
7.990

decalife

CORDLESS
Kitchen Appliance

Makinë Rroje me bateri

KMHS029R

- Bateria Ni-Cd 600 mAh
- Teh çeliku
- Madhësia: 158 x 37 mm
- Gjatësia e prerjes: e rregullueshme
- Me krehër 3 mm, 6 mm, 9 mm
- Koha e punës: 50 min
- Koha e karikimit: 8 orë
- Kabull USB, furçë, shishe vaji



Çmimi
790

CORDLESS
Kitchen Appliance

E RE

Kafetiere Moka

KMCF023M

- Kapaciteti: 6 filxhanë
- Dimensioni: 168 x 105 x 203 mm
- Materiali: Alumini
- Peshë: 380 g (+/-10 g)
- Dorezë rezistente ndaj nxehtësisë



Çmimi
990

decaDeal

Bërës kafeje Tuke (1-4 filxhan)

KECF030B

- Fuqia: 500 W
- Kapaciteti: 250 ml
- Fikje automatike mbas zjerjes
- Tregues i nivelit të ujit
- Lugë mase
- Pllakë ngrohëse: SUS 304



Çmimi
2.500

decalife

Kafe filtër (10 filxhanë)

KECF001B

- Fuqia: 750 W
- Kapaciteti: 1.25 L
- Funkcion ruajtje nxehtësie
- Filtër najloni dhe lugë mase
- Buton ndezje ON/OFF
- Mbrojtje nga tharja e zierjes
- Funkcion kundër pikimit 30 sec



Çmimi
1.990

decaDeal

Fritezë

KEEC056M

- Fuqia: 2000 W
- Kapaciteti: 3L
- Tensioni: 220-240 V
- Temp. e rregullueshme: 115-190°C
- Materialet: çelik inoxi
- Me mbrojtje nga mbinxehja
- Enë e brendshme e lehtë për t'u pastruar
- Shportë me dorezë të palosshme



Çmimi
4.900

E RE

Copëzues ushqimi

KEMG013R

- Fuqia: 400 W
- Kapaciteti: 1.5 L
- Motorr me thurrje bakri
- Thikë me tre helika
- Buton me prekje
- Copëzon edhe akullin



Çmimi
3.590



Copëzues ushqimi

E RE

KEMG011B

- Fuqia: 300 W
- Tensioni: 220-240 V
- Kapaciteti: 2 Lt
- 2 nivele shpejtësie
- Enë qelqi, trup inoksi
- Teh i mprehtë me 2 shtresa
- E lehtë për tu pastruar



Çmimi
2.190

Grirëse mishi

KEMG021B

- Fuqia: 600 W
- Kapaciteti: 1.5 kg/min
- Bazament kundra rrëshkitjes
- Rrotullim thike para dhe mbrapa
- 1 thikë, 2 pjata dhe 1 kallup



Çmimi
4.990



Mikser dore

KEMX001W

- Fuqia: 200 W
- 6 nivele shpejtësie dhe turbo
- 2 funksione: rrahje dhe përzierje



Çmimi
1.790



Mikser dore

KEMX016W

- Fuqia: 120 W
- Tensioni: 220-240 V
- 7 nivele shpejtësie
- 2 tehe inoksi
- 2 rrahëse



Çmimi
990

Mikser me enë inoksi

KEMX003B

- Fuqia: 600 W
- Enë inoksi: 5 L
- 7 nivele shpejtësie
- Kokë mikseri e lëvizshme
- Mbrojtëse transparente
- Aksesor rrahje dhe përzierje



Çmimi
7.990



Zjerës vezësh

KEEG003W

- Fuqia: 350 W
- Kapaciteti: 7 vezë
- Tregues fuqie
- Tabaka e çmontueshme



Çmimi
1.990



Shkumues qumështi

KECF015W

- Fuqia: 550 W
- Kapaciteti për ngrohje: 210 mL
- Kapaciteti për shkumim: 80 mL
- Materiali: çelik karboni
- Koha e shkumimit: 2 min



Çmimi
3.900



Blender elektrik

KEJB045L

- Fuqia: 650 W
- Tensioni: 220-240 V
- Kapaciteti: 1.5 Lt
- 2 nivele shpejtësie
- 6 tehe inoksi, enë qelqi
- Motor me tela bakri
- Kundër rrëshqitjes së këmbëve



Çmimi

3.900

Blender elektrik

E RE

KEJB001W

- Fuqia: 400 W
- Kapaciteti: 1.5 Lt
- 2 nivele shpejtësie
- Tehe inoksi
- Enë plastike
- Kundër rrëshqitjes



Çmimi

2.500

Ngrohës uji elektrik

KEKT002B

- Fuqia: 1500-1800 W
- Kapaciteti: 1.5 L
- Materiali: inoks
- Mbrojtje nga shterimi
- Me llambë treguese
- Filtër i integruar
- Fikje automatike



Çmimi

1.590

decaDeal

Ngrohës uji elektrik

KEKT004W

- Fuqia: 1850-2200 W
- Kapaciteti: 1.7 L
- Materiali: inoks
- Mbrojtje nga shterimi
- Me llambë treguese
- Filtër i integruar
- Fikje automatike



Çmimi

1.990

decalife!

Pjekëse halogjene

E RE

KEEC072W

- Fuqia: 1200-1400 W
- Kapaciteti: 12L
- Tensioni: 220-240 V
- Tas qelqi rezistent ndaj nxehtësisë
- Mbrojtje e ulët, mbajtje e lartë
- 1 kapëse
- Gatvani 2-3 herë më shpejt se furra standarte
- Kursen deri në 60% energji



Çmimi

4.500

decalife!

Air fryer

E RE

KEEC036V

- Fuqia: 1400 W
- Kapaciteti: 3.5 Lt
- Mbrojtje nga mbinxehja
- Depozitë që nuk ngjit
- Temp. e rregullueshme 80-200°C
- Këmbë që nuk rrëshqasin



Çmimi

3.990

decalife!

Shtrydhëse frutash

KEJC006W

- Fuqia: 40 W
- Kapaciteti: 0.5 L
- Motorr rrotullues në dy drejtime
- Kupë transparente



Çmimi

1.590

decaDeal

Shtrydhëse frutash

E RE

KEJC008B

- Fuqia: 160 W
- Trup inoksi
- Sistem kundra rrëshqitjes
- Filtër i çmontueshëm
- E lehtë për tu pastruar
- Dorezë e gomuar



Çmimi

3.590

decalife!

Toster

KEEC046B

- Fuqia: 750 W
- Kapaciteti i pllakës: 215 × 125 mm
- Temp. e pllakës së gatimit: 180±10°C
- Koha e nxehtjes: 90-150 sek
- Kontroll me termostat
- Veshje kundër ngjitjes
- Bazament kundër rrëshqitjes



Çmimi
1.590



Toster

KEEC047R

- Fuqia: 750 W
- Kapaciteti i pllakës: 215 × 125 mm
- Temp. e pllakës së gatimit: 180±10°C
- Koha e nxehtjes: 90-150 sek
- Kontroll me termostat
- Veshje kundër ngjitjes
- Bazament kundër rrëshqitjes



Çmimi
1.590



Toster

KEEC058W

- Fuqia: 650 W
- Kapaciteti i pllakës: 142 × 142 mm
- Temp. e pllakës së gatimit: 200±10°C
- Koha e nxehtjes: 3 min
- Kontroll me termostat
- Veshje kundër ngjitjes
- Me llambë treguese



Çmimi
1.990



Pllakë Grill/ Pllakë Waffle

KMEC059B

- Pllakë për KEEC058W, KUEC058W
- Pllakë kundër ngjitjes
- Kapaciteti i pllakës: 142 × 142 mm



KMEC061B

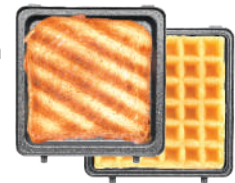

Çmimi
490



Pllakë Ovale/ për petulla

KMEC062B

- Pllakë për KEEC058W, KUEC058W
- Pllakë kundër ngjitjes
- Kapaciteti i pllakës: 142 × 142 mm



KMEC065B



Çmimi
490



Pllakë Rumbullake (për krepë)

KMEC063B

- Pllakë për KEEC058W, KUEC058W
- Pllakë kundër ngjitjes
- Kapaciteti i pllakës: 142 × 142 mm



Çmimi
490



Thekëse buke me 2 anë

KETS001W

- Fuqia: 700 W
- Kapaciteti për dy feta
- 6 nivele thekjeje
- Zgara të lëvizshme



Çmimi
1.590



Thekëse buke me 4 anë

KETS011B

- Fuqia: 1200-1400 W
- Kapaciteti për katër feta
- 7 nivele thekjeje
- Funkzioni: ngrohje dhe shkrirje
- Zgara të lëvizshme



Çmimi
2.690



Tenxhere presioni Multi Cooker

E RE

KEER041M

- Fuqja: 900 W
- Kapaciteti: 5L
- Tensioni: 220-240 V
- 9 funksione të parakonfiguruar
- Veshje jo ngjitëse
- 1 lugë, 1 filnshan matës
- Kabull rryme
- Ekran LED



Çmimi
6.900

Tenxhere presioni

KMER018M

- Kapaciteti: 5.5 L
- Presioni: 60-80 kPa
- Tensioni i baterisë: 220-240 V
- Materiali: aliazh alumini A3003
- Lustrim i jashtëm
- Dorezë bakeliti



Çmimi
3.490

decaDeal

Tenxhere

KMEP007B

- Madhësia: 16 x 7 cm
- Trashësia: 2.0 mm
- Pesha: 750 g
- Materiali: alumin
- Veshje jo ngjitëse me dy shtresa
- Me kapak xhami të temperuar



Çmimi
990

decalife!

Tenxhere

E RE

KMEP009B

- Madhësia: 24 x 11 cm
- Trashësia: 2.3 mm
- Pesha: 1.3 Kg
- Materiali: alumin
- Veshje jo ngjitëse me dy shtresa



Çmimi
1.890

decalife!

Set kuzhine me tenxhere

E RE

KMEP006B

- Set enë gatimi, 11 copë
- Tenxhere 16 x 7 cm me kapak
- Tenxhere 20 x 8 cm me kapak
- Tenxhere 22 x 10 cm me kapak
- Tenxhere 22 x 4 cm
- 4 spatulla najloni
- Trashësia: 2.1 mm, materiali: alumin



Çmimi
3.900

decalife!

Tigan për skuqje

E RE

KMEP001B

- Madhësia: 20 cm
- Trashësia: 2.5 mm
- Pesha: 410 g
- Materiali: alumin
- Veshje jo ngjitëse me dy shtresa



Çmimi
890

decalife!

Tigan për skuqje

E RE

KMEP002B

- Madhësia: 24 cm
- Trashësia: 2.5 mm
- Pesha: 553 g
- Materiali: alumin
- Veshje jo ngjitëse me dy shtresa



Çmimi
990

decalife!

Set enë kuzhine (6 copë)

KMTT045B

- Madhësia: najlon, material jo ngjitës
- Lugë me vrima: 30 x 6,5 x 5 cm
- Lugë e fortë: 30 x 6.5 x 5cm
- Lugë: 30 x 9,5 x 7,5 cm
- Lugë makaronash: 29.5 x 6.5 x 5.5 cm
- Rrotullues me vrima: 31 x 9 x 4,5 cm
- Spatulat: 30 x 9 x 4.5 cm



Çmimi
750

decalife!

Spatul silikoni

E RE

KMTT071R

- Materiali silikon
- Madhësia: 20.5 x 3.8 cm
- Peshë: 35 g
- Rezistencë ndaj temp. -30°C deri 230°C
- I lehtë për t'u përdorur



Çmimi
150



Presëse pice

E RE

KMTT068B

- Materiali: inoks
- Dorezë e parrëshqitshme
- Perfekt për prerjen e picës, byrekut, brumit të ëmbëlsirave, etj



Çmimi
290



Shtrydhëse limoni

E RE

KMTT069Y

- Materiali alumin
- Madhësia: 22 x 7.5 cm
- Peshë: 175 g
- I lehtë për t'u përdorur



Çmimi
450



Prerëse patatesh

E RE

KMTT085W

- Materiali PP+S/S 201
- Madhësia: 9.6 x 8 x 13.3 cm
- Peshë: 192 g
- Tehet inoxi
- I dobishëm dhe për përbërës si karrotat, kastravecat, qepët, vezët, djathin, etj



Çmimi
490



Rrahëse inoksi

KMTT064M

- Materiali: çelik inoksi
- Përmasat: 30,5 x 6,5 cm
- Peshë: 53.7 g
- Trashësia: 1.4 mm
- I lehtë për t'u pastruar



Çmimi
150



KMTT065M

Grirëse qepe manuale

KMTT084W

- Materiali: PP+PS+ABS+TPR+S/S 18/0
- Madhësia: 12,5 x 9,3 cm
- Peshë: 195 g
- Kapaciteti: 400 ml
- Tehe inox për prerje efikase
- Kundër rrëshqitjes
- Nuk kërkohet energji elektrike



Çmimi
450



Termus portabel

E RE

KMTT024W

- Kapaciteti: 566 ml
- Materiali: inoks
- Madhësia: 88 x 175 mm
- Peshë: 300g
- I sigurt në larës enësh
- Me izolim të dyfishtë vakum për të mbrojtur temperaturën



Çmimi
1.490



Formë pjekje keku

E RE

KMTT081B

- Materiali çelik karboni
- Madhësia: 2.5 x 10.5 cm
- Peshë: 459 g
- Trashësia: 0.4 mm
- Rezistencë ndaj temp. 230°C
- E përkryer për ëmbëlsirat



Çmimi
450



Peshore kuzhine me ekran

KMTT014P

- Kapaciteti: 2-5000 g
- Fikje automatike
- Ekran LCD
- Temperatura e punës: 5-60°C
- Me buton ON/OFF



Çmimi
1.490



Peshore kuzhine

KMTT012B

- Kapaciteti: 2-5000 g
- Fikje automatike
- Ekran LCD
- Temperatura e punës: 5-60°C
- Me buton ON/OFF
- Me enë të përfshirë



Çmimi
1.590



Fshesë portative 2 në 1

CECV006B

- Fuqia: 600 W
- Fshesë portative
- Qese pluhuri: 0.6 L
- Gjatësia e kabullit: 3.5 M

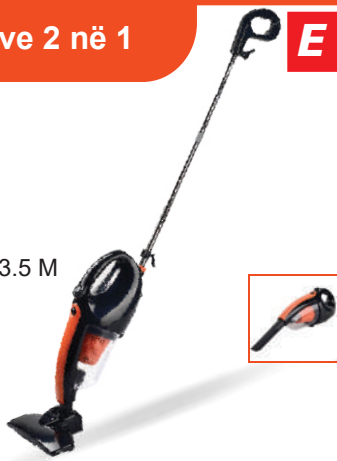

E RE

Çmimi
3.900

Fshesë korenti

CEVC002B

- Fuqia: 1200 W
- Depozita: 2 L
- Presioni 22 kPa
- Gjatësia e kabullit: 4 m
- Funksion treguesi të pluhurit
- Rrotullues automatik i kabullit



E RE

Çmimi
5.990



Pastruese me avull

KEEN017W

- Fuqia: 1800 W
- Depozita: 1.5 L
- Presioni: 5 bar
- Gjatësia e kabullit: 2.5 m
- Koha e ngrohjes: 7 min
- Përfshirë 15 aksesorë



Çmimi
7.990



Fshesë robotike

DECABOT06

- Depozita: 450 ml
- Presioni: 1300 Pa
- Gyroscope style
- Koha e punës: 90 min
- Koha e karikimit: 4-5 orë
- Me furçë elektrike
- Me sensorë kundër ndërprerjeve



E RE

Çmimi
15.900



Hekur me pllakë tefloni

KEEN019V

- Fuqia: 1200-1400 W
- Kapaciteti i depozitës: 150 ml
- Pllakë teflon
- Përmasa: 183 x 100 mm
- Kontroll mekanik temperature
- Shkalla e avullit: 0-15 g/min



Çmimi
1.390



Hekur me pllakë telfoni

KEEN001W

- Fuqia: 2000 W - 2400 W
- Kapaciteti i depozitës: 210 ml
- Pllakë telfoni
- 5 nivele nxehtësie
- Përmasa: 223 x 120 mm
- Kontrolli mekanik i temperaturës
- Shkalla e avullit: 30 g/min



E RE

Çmimi
2.790



Hekur me kaldajë

KEEN006B

- Fuqia: 2000-2250 W
- Kapaciteti i depozitës : 1100 ml
- Pllakë qeramike
- Përmasa: 228 x120 mm
- Ngrohja paraprake: 40 S
- Shkalla e avullit: 40 g/min



Çmimi
6.990



Tharëse flokësh

KEHS007W

- Fuqia: 1600 W
- Dorezë e palosshme
- 2 nivele shpejtësie
- 3 nivele nxehtësie
- 200 x 80 x 250 mm
- Gjatësia e kabullit: 1.65 m



Çmimi
1.490



Tharëse flokësh

KEHS032L

- Fuqia: 1800-2200 W
- Kokë difuzori
- 2 nivele shpejtësie
- 3 nivele nxehtësie
- Gjatësia e kabullit: 1.8 M
- Difuzor + kokë



Çmimi
1.990



Tharëse flokësh

KEHS011W

- Fuqia: 2200 W
- Funksion jonik
- 2 nivele shpejtësie
- 3 nivele nxehtësie
- 226 x 87 x 260 mm
- Gjatësi kabulli: 1.8 m + difuzor



Çmimi
2.490



Piastër flokësh

KEHS034B

- Fuqia: 43W
- Kapaciteti: 12L
- Tensioni: 220-240 V
- Temperatura maksimale 210°C
- Me pllaka qeramike 120 x 25 mm
- Me funksion ndalimi
- Gjatësia e kabullit 1.7M
- Kursen deri në 60% energji



Çmimi
1.190

Ngrohëse 2000 W

KEFH002W

- Fuqia: 2000 W
- Me termostat
- Kontroll automatik
- Mbrojtje nga mbinxehja
- Pesha: 1 kg
- 200 x 80 x 250 mm



Çmimi
1.490



Ngrohëse 2000 W

KEFH003W

- Fuqia: 2000 W
- Me termostat
- Kontroll automatik
- Mbrojtje nga mbinxehja
- Pesha: 1.15 kg
- 260 x 260 x 120 mm



Çmimi
1.890



Ngrohëse me Quartz

KEFH001B

- Fuqia: 1200 W
- Tensioni: 220-240 V
- 3 grupe ngrohjeje
- Me dorezë portative
- Mbrojtje nga mbinxehja
- Pesha: 1.6 kg
- 320 x 260 x 460 mm



Çmimi
1.990

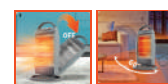

Ventilator

E RE

KEFC009B

- Fuqia: 60 W
- Tensioni: 220 V
- 3 nivele shpejtësie
- Ventilator 18"
- Diametri i bazës: 500 mm me vrima
- 5 helika plastike, skarë plastike 18"
- Lartësi e rregullueshme

Çmimi

3.390



decaDeal

Ventilator 3 në 1

E RE

KEFC008B

- Fuqia: 60 W
- Tensioni: 220 V
- 3 nivele shpejtësie
- Ventilator 3 në 1, 18"
- Diametri i bazës: 500 mm me 5 vrima
- 5 helika plastike, skarë plastike 18"
- Lartësi e rregullueshme, 3 modele

Çmimi

3.690



Tavë elektrike

E RE

KEEC051B

- Fuqia: 1500 W
- Mbrojtje nga mbinxehja
- Madhësia: 300 x 300 mm
- Materiali: jo ngjitës me dy shtresa
- Dy doreza të izoluar
- Kapak xhami
- Dritë treguese e ndezjes/fikjes

Çmimi

2.790



Tavë elektrike për pica

KEEC052B

- Fuqia: 1500 W
- Mbrojtje nga mbinxehja
- Madhësia: 320 x 300 mm
- Materiali: jo ngjitës me 2 shtresa
- Doreza të izoluar
- Kapak xhami

Çmimi

2.590



decaDeal

Furrë elektrike

E RE

KEEV007B

- Fuqia: 650 W
- Tensioni: 220-240 V
- Kapaciteti: 10 Lt
- Kontrolli i temp. 100°C~230°C
- Elementet ngrohëse me kuarc
- Dorezë inoksi

Çmimi

3.500



Mikrovalë

E RE

KEMC007W

- Fuqia: 1150 W
- Tensioni: 220-240 V
- Kapaciteti: 20 L
- 6 nivele të fuqisë së mikrovalës
- Kohëmatësi i gatimit: 30 min
- Tabaka qelqi rrotulluese: 245 mm
- Sinjali i përfundimit të gatimit

Çmimi

10.500



Furnellë elektrike me 2 vatra

E RE

KECC005B

- Fuqia: 1000 W + 1000 W
- Tensioni: 220-240 V
- 2 vatra
- 5 nivele nxehtësie
- Sipërfaqe gize
- E përdorshme tek të gjitha enët e gatimit metal, qelq, qeramikë

Çmimi

2.190



decalife!

Furnellë gazi me 2 vatra

E RE

KMGS013M

- Fuqia: 3.2 Kw + 3.2 Kw
- Presioni: 2800 Pa
- Diametri i vatrës: 90 mm
- Tub gazi në formë L
- Ndezja automatike
- Panel inoksi

Çmimi

3.790





Zgare me gas

KMGS005B

- Fuqia: 5.5 kW
- Lartësia: 86 cm
- Zona e gatimit: 48.5 × 37.5 cm
- Injektori kryesore 0.84 mm, anësor 0.75 mm
- Valvula alumini
- Tavolinë anësore
- Kapak inoksi, me rrota

Çmimi

18.500



E RE



Zgarë me gas

KMGS006B

- Fuqia: 11.5 kW
- Lartësia: 82 cm
- Zona e gatimit: 63 × 37 cm
- Valvula alumini, rretë gatimi
- Tavolinë anësore
- Kapak inoksi, me rrota

Çmimi

37.500



E RE



Zgarë me qymyr

KMCC008B

- Lartësia: 82 cm, e rregullueshme
- Zona e gatimit: 58 x 42.5 cm
- Tabaka me qymyr
- 2 copë rretë gatimi me tela të kromuar
- Raft ngrohës me tela të kromuar
- Me rrota 50 x 25 mm
- Kapak inoksi

Çmimi

21.500



E RE



Barbekju me qymyr dhe rrota



BBQ1145

- + tavoline dhe mbledhese 47 cm



Çmimi
4.290

Barbekju me qymyr, raft dhe rrota



BBQ1140

- 50 x 26 cm



Çmimi
5.900

Barbekju me qymyr, raft dhe rrota



BBQ1160

- Mbledhese hiri F 56cm



Çmimi
7.500

Barbekju me qymyr, raft dhe rrota



BBQ1170

- 76x40 cm



Çmimi
13.500

Barbekju me gas, kapak dhe rrota



BBQ2000

- Fuqia: 7.2 Kw



Çmimi
23.500

Barbekju me gaz dhe 3 vatra



BBQ3000

- Fuqia: 10.8kW
- Dimensione të rrjetit: 60 x 45cm
- Pa zgare anesore



Çmimi
27.900

Barbekju me gaz dhe 3 vatra



BBQ3100

- Fuqia: 17.1kW
- Me zgare anesore



Çmimi
39.500

Rregullator gazi



BBQ1008

- Rregullator gazi me tub
- Gjatesia e tubit ±60cm



Çmimi
1.790

Barbekju me qymyr dhe rrota



99580

• 47x47x73



Çmimi
4.500

Tel zgare inoksi dysh



BBQ1001

• Permasa: 35X25 cm



Çmimi
1.350

Set barbeque valixhe 16 copesh



BBQ1015



Çmimi
5.900

Furce pastrimi per barbekju



BBQ1018

• Permasa: 21 cm



Çmimi
290

Barbekju me qymyr, raft dhe rrota



99585

• 82x33x85 cm



Çmimi
4.990

Tel zgare inoksi dysh me dopio mbajtëse



Kodi	Te dhena	Paketimi	Cmimi
BBQ1004	35 x 25 cm	1 Cope	1.390
BBQ1011	35 x 25 cm	1 Cope	1.690

Tel zgare inoksi



BBQ1017

• Permasa: 40x30 cm



Çmimi
1.150

Tel zgare inoksi dysh per peshk



BBQ1019

• Permasa: 66x14 cm



Çmimi
890

1
2
3
4
5
6
7
8
9
10

Zgarë portative me gas



104997

- Fuqia: 1.9 kW
- Shtresë jo ngjitëse
- Ideale për pjekje në sgarë
- Sipërfaqja: 27 X 34 cm



Çmimi
4.500

Zgarë portative me bombël të vogël



104998

- Bombël e vogël gazi
- Shtresë inoxi jo ngjitëse
- Ideale për kampe, shëtitje me varkë dhe gatim në natyrë
- Sipërfaqe: 34 X 25 cm



Çmimi
4.500

Furnellë elektrike



104991

- Fuqia: 450W
- Diametri: 90 mm
- Strukture Inoxi



Çmimi
1.590

Pjatë zgarë



104987P

- Pjatë për furnellë 104987
- Material kundra ngjitjes së gatimit
- Përmasa: 27 x 34 cm



Çmimi
1.390

Ngrohës ushqimi mini me gaz



1059KIT

- Ndezje me çentil
- Rregullator flake
- Bombël 227 gr
- Ideale për karamelizimin e ëmbëlsirave, skuqjen e mishit dhe thekjen e farave



Çmimi
2.390

Kokë për furnellë 106110



106110

- E përshtatshme për bombël gazi 2-3-5 Kg
- E sigurt në përdorim
- Kokë e kromuar
- Ideale për kamping dhe gatim në natyrë



Çmimi
1.400

Tymues ushqimesh



SB-01

- Lehtësisht i pastrueshëm
- Ideal për peshk, mish, preime e fruta
- Gjatësia e tubit lidhës 25 cm



Çmimi
1.990

Lageshtues ambjenti



UMU-100

- Depozitë 1.2 Lt
- Konsumi i kufizuar i energjisë
- Ideale për lagështimin e dhomës



Çmimi
2.500

Largues minjsh dhe gjarpërinjsh



AR-T2

- Largues për minj dhe gjarpërinj me bateri
- Për ambiente deri në 625 m²
- Funksonon me tinguj dhe vibrim



Çmimi
1.990

Neon për vrasës insektesh



EIN-16

- Fuqia: 8 watt
- Neon Rezerve



Çmimi
1.990

Vrasës mushkonjash me staiv



EIN-G

- E pajisur me llampë 7 W
- E pajisur me kabëll 2 m
- E përshtatshme për çdo lloj
- Ndezje automatike me sensor drite
- mm 255 x 255 x 1100



Çmimi
4.990

Reflektor vertikal me tre llampa



ALN-1200

- 3 nivele fuqie: 400/ 800/ 1200 W
- Sipërfaqe mbulimi 25 m²
- Lëkundje automatike 180°
- Sistem kundër animit
- Dorezë mbajtëse



Çmimi
3.990

Vrasëse insektesh elektrike



EIN-12

- Dy llamba neoni 6 W
- Me sinjalizues për kapjen e miut



Çmimi
3.900

Vrasëse insektesh elektrike



EIN-6

- Fuqia: 1000 W
- E pajisur me llampë 6 W
- Rreze veprimi 20 m²
- E pajisur me sirtar për grumbullimin e insekteve + grep varës

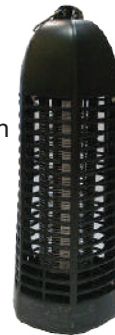

Çmimi
1.590

Ngrorhës elektrik Convex



TC-2000

- 3 nivele nxehtësie 750/1250/ 2000 W
- Siperfaqe mbulimi 20 m²
- Termostat të rregullueshëm
- Kundër mbinxehjes
- Doreza anësore
- Këmbë plastike kundër gërvishetjeve



Çmimi
3.900

Kalorifer me vaj



ERC2-1507

- Fuqia: 1500 W
- 3 nivele gradimi
- Numri i fletëve: 7



Çmimi
9.900

Ngrohës elektrik me programim



TC-SPD2000

- Fuqia 2000 W
- E pajisur me telekomandë
- Sipërfaqe mbulimi 20 m²
- Ideale për ngrohje ose ftohje
- Për temp. nga 10° deri në 49°



Çmimi
10.500

Stativ për reflektorin 65432KW20



AA602

- Reflektor me stativ për ambiente të jashtme 1.5 - 2 Kw
- Llampë halogjene
- Kënd ngrohje i rregullueshëm
- Kënd ngrohje i rregullueshëm
- ↙ mm 590 x 110 x 77



Çmimi
5.500

Ngrohës me ventilim



TV-SL

- Ngrohës elektrik me ventilim me dy nivele fuqie
- Termostat rregullues për ambientin
- Termostat rregullues për mbi-nxehjen
- ↙ mm 250 x 105 x 270



Çmimi
2.990

Ngrohës me ventilim



TV-T24

- 2 nivele nxehësie 1800/ 2000 W
- Siperfaqe mbulimi 20 m²
- Termostat të rregullueshëm
- Kundër mbinxehjes
- Funkzioni i ajrosjes gjatë verës
- Dorezë në pjesën e pasme



Çmimi
3.990

Reflektor muri



65432KW20

- Reflektor muri për ambiente të jashtme 2 Kw
- Llampë halogjene
- Kënd ngrohje i rregullueshëm
- Kabëll 5.0 m
- Rezistente ndaj ujit
- ↙ mm 615 x 110 x 160



Çmimi
8.500

Ngrohëse me ventilim



TV-EC

- Ngrohës me ventilim me 2 gradime ventilim dhe mbrojtje termike 2000W
- Temperaturë e rregullueshme
- I përshtatshëm për ambiente të vogla
- Me dorezë mbajtëse
- ↙ mm 205 x 130 x 250



Çmimi
1.990

Mini ngrohëse qeramike



CM-1500

- Mini ngrohëse me pllakë qeramike
- Dy nivele fuqie 1000/ 1500 W
- Mbrojtje termike
- Termostat sigurie
- E pajisur me filtër ajri
- Sipërfaqe mbulimi 20 m²



Çmimi
3.900

Ngrohës me ventilim



BEH5200

- 2 nivele nxehësie 1000/ 2000 W
- Mbrojtje nga mbinxehja
- Termostat të rregullueshëm
- Kundër mbinxehjes
- Funkzioni i ajrosjes gjatë verës
- Dorezë në pjesën e pasme



Çmimi
3.900

Ngrohës me ventilim



BEH5210

- 2 nivele nxehtësie 1000/ 2000 W
- Mbrojtje nga mbinxehja
- Termostat të rregullueshëm
- Kundër mbinxehjes
- Funkzioni i ajrosjes gjatë verës
- Dorezë në pjesën e pasme



Çmimi
1.900

Ventilator tavoline



BFN1025

- Fuqia: 40W
- Diameter: 30 cm



Çmimi
2.690

Ventilator tavoline



BFN2025

- Fuqia: 40W
- 3 nivele shpejtesie
- 3 helika
- Ngjyra e bardhe



Çmimi
2.990

Ventilator Industrial



BFN8115

- Fuqia: 80W
- Dimensioeni: 50 cm
- 3 nivele shpejtesie
- 3 helika



Çmimi
5.990

Freskuese me shume helika



BFN4015

- Fuqia: 45W
- 3 nivele shpejtesie
- 3 helika
- Ngjyra e bardhe



Çmimi
6.500

Freskuese murale



BFN6110

- Fuqia: 70 W
- Permasa: 120 cm
- Me telekomande dhe drite



Çmimi
12.900

Kondicioner per ftohje i bardhe



BFN5615

- Fuqia: 65 W
- Me rrota dhe telekomande
- Depozite uji: 6 L
- Me 3 nivele shpejtesie
- Motor alumini



IRI

Çmimi
7.990

Kondicioner



BFN5610

- Fuqia: 80 W
- Dimensionet: 25 x 26.5 x 57 cm
- Me rrota dhe telekomande
- Depozite uji: 4 L
- Furnizimi me ajer: 300m³/h
- Motor alumini
- Pesha: 4.46 kg



Çmimi
8.900

PRODUKTE SHTEPIAKE

Te lehta, elegante dhe perfekte për çdo ambient.

Komode dhe lehtësisht te palosshme dhe magazinueshme.

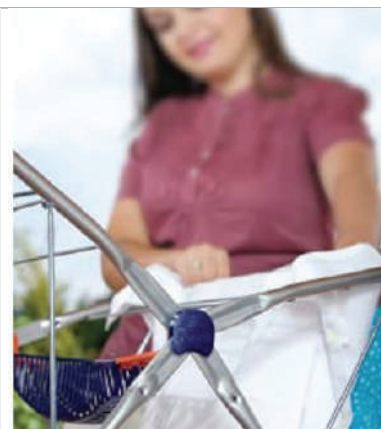
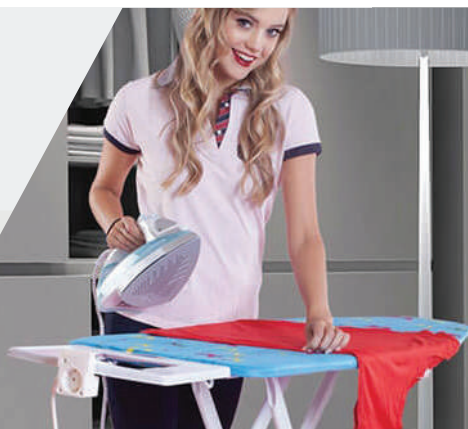

Tavoline hekurosje Lux Tach

2302

- Sipërfaqja e sipërme e hekurosjes me rrjetë
- Mbulesa teflon rezistente ndaj nxehtë-
- Dizajni i veçantë për të lehtësuar hekurosjen
- Gjatesia: 1.75m, Gjerësia: 0.38m
Lartësia: 1.48m, Pesha 4.6 kg



Çmimi
2.900

Tavoline hekurosje Evita

2201

- Rregullimi automatik i lartësisë 60 deri në 90 cm
- Sipërfaqja e sipërme e hekurosjes me rrjetë
- Dizajni i veçantë për të lehtësuar hekurosjen
- Gjatesia: 1.42m, Gjerësia: 0.34m
Lartësia: 0.9m, Pesha 5.2 kg



Çmimi
3.390

Tavoline hekurosje Europa Capitol

2206

- Sipërfaqja e sipërme e hekurosjes me rrjetë
- Mbulesa teflon rezistente ndaj nxehtësisë
- Dizajni i veçantë për të lehtësuar hekurosjen
- Gjatesia: 1.43m, Gjerësia: 0.38m
Lartësia: 0.9m, Pesha 7.21 kg

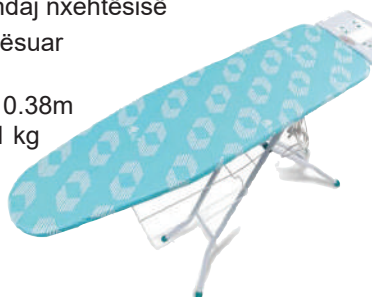

Çmimi
3.990

Tavoline hekurosje Rayan

2226

- Rregullimi automatik i lartësisë 60 deri në 90 cm
- Sipërfaqja e sipërme e hekurosjes me rrjetë
- Dizajni i veçantë për të lehtësuar hekurosjen
- Gjatesia: 1.55m, Gjerësia: 0.42m
Lartësia: 0.91m, Pesha 7.8 kg



Çmimi
4.990

Tavoline hekurosje Flash New

2228

- Rregullimi automatik i lartësisë 60 deri në 90 cm
- Sipërfaqja e sipërme e hekurosjes me rrjetë
- Dizajni i veçantë për të lehtësuar hekurosjen
- Gjatesia: 1.67m, Gjerësia: 0.42m
Lartësia: 0.9m, Pesha 8.5 kg



Çmimi
5.500

Tavoline hekurosje Flash New

2229

- Rregullimi automatik i lartësisë 60 deri në 90 cm
- Sipërfaqja e sipërme e hekurosjes me rrjetë
- Dizajni i veçantë për të lehtësuar hekurosjen
- Gjatesia: 1.58m, Gjerësia: 0.46m
Lartësia: 0.95m, Pesha 9.35 kg



Çmimi
5.990

ERE

Nderese rrobash Platine Liva

3315

- Nderese rrobash metalike
- Gjatesia: 1.80m, Gjeresia: 0.54m
Lartesia: 1.15m, Pesha 2.85 kg



Çmimi
1.490

Nderese rrobash Caprice

3304

- Nderese rrobash metalike
- Gjatesia: 1.74m, Gjeresia: 0.55m
Lartesia: 1.11m, Pesha 4.10 kg

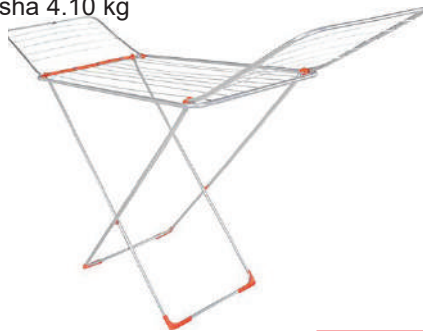

Çmimi
2.590

Nderese rrobash Define

E RE

3312

- Nderese rrobash metalike
- Gjatesia: 1.80m, Gjeresia: 0.56m
Lartesia: 1.17m, Pesha 2.55 kg

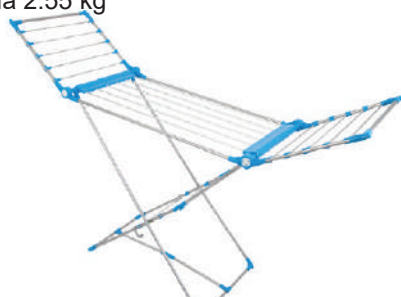

Çmimi
4.290

Mbulese per tavoline hekurosje

2701

- Permasa: 130 x 45 cm



Çmimi
950

Nderese rrobash Rennie M

E RE

3302

- Nderese rrobash m
- Gjatesia: 1.89m, Gjeresia: 0.61m
Lartesia: 0.9m, Pesha 4.1 kg

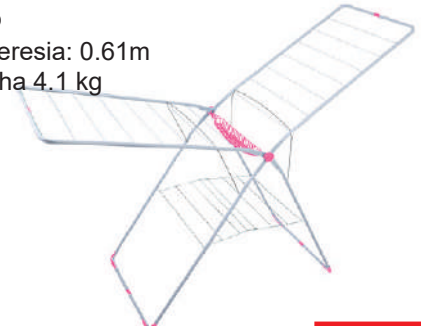

Çmimi
1.490

Nderese rrobash Begonia

E RE

3308

- Nderese rrobash metalike me mbajtese te dyfishte
- Gjatesia: 1.80m, Gjeresia: 0.38m
Lartesia: 0.5m, Pesha 2.11 kg



Çmimi
3.790

Nderese rrobash Cabrice

E RE

3316

- Nderese rrobash metalike
- Gjatesia: 1.80m, Gjeresia: 0.60m
Lartesia: 1.60m, Pesha 7 kg

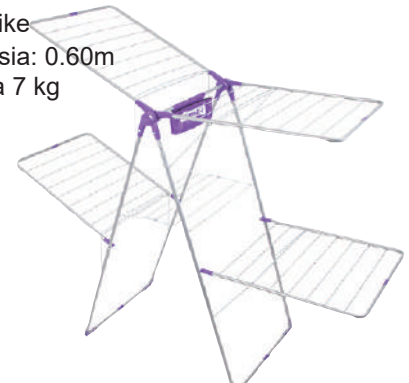

Çmimi
4.290

Mbulese per tavoline hekurosje

2702

- Permasa: 140 x 52 cm



Çmimi
990

1
2
3
4
5
6
7
8
9
10



Cader per kopesht me bazament

BSP1030

- Lartesia: 3 m
- Bazamenti: 48 mm



Çmimi
9.900

Cader per kopesht

BSP1035

- Lartesia: 3 m
- Diametri i tubit: 3 mm



Çmimi
6.500

Set per verande

BSP1168

- Karrige njevendeshe x 2
- Nje karrige dyvendeshe x1
- Tavoline katrore xhami



Çmimi
19.900

Lekundese per 3 persona

BSP1050

- Struktura metalike
- Permasa: 170x100x153 cm
- 3 Persona



Çmimi
12.500

Lekundese per kopesht

BSP1122

- Permasa: 275x140 cm



Çmimi
2.290

Karrige per verande ngjyre gri

BSP1130

- Permasa: 55x78x91 cm



Çmimi
3.690



Tavoline xhami per verande

BSP1140

- Permasa: 150x90x72 cm
- Struktura metalike



Çmimi
11.900

Set me 4 karrige te palosshme

BSP1152

- Struktura metalike
- Ngjyra: Gri



Çmimi
4.690

Tavoline plastike me xham te zi

BSP1156

- Permasat: 150x90x72 cm
- Struktura alumini



Çmimi
16.900

Tavoline xhami per verande

BSP1145

- Permasa: 60x72 cm
- E rrumbullaket
- Struktura metalike



Çmimi
3.990

Jastek per karrige te jashtme

BSP1154

- Permasat: 50x100x8 Cm



Çmimi
2.200

Karrige metal gri e palosshme

BSP1164

- Struktura metalike
- Permasa: 52x43x80 cm



Çmimi
2.990

Tavoline pikniku e palosshme
BSP1149

- Permasa: 80x60x70 cm
- Kembe metalike

ERE

 Çmimi
3.200
Tavoline dhe 4 karrige potative
BSP1150

- Alumini

ERE

 Çmimi
5.990
Tende e palosshme
BSP1025

- Permasa: 3x3 m
- Rezistente ndaj ujit
- E palosshme

ERE

 Çmimi
10.500
Cader plazhi me korniza metal
BSP1037

- Permasa: 200xH200 cm

ERE

 Çmimi
2.200
Bazament per cader kopeshti
BSP1040

- Diameter bishti: 38/48 mm

ERE

 Çmimi
3.690
Shezllon me strukture metal
BSP1170

- Permasa: 66x153x104 cm
- Kapacitet: 100 kg
- Gri

ERE

 Çmimi
5.500
Karrige portative plazhi gri
BSP1176

- Struktura metalike
- Permasa: 53x55x73 cm

ERE

 Çmimi
1.890
Karrige portative plazhi blu
BSP1175

- Struktura Metalike
- Permasa: 66x153x104 cm

ERE

 Çmimi
1.790

Poltrol lekundes

BSP1166

- Permasa: 95 x 95 x 196 cm

ERE



Çmimi
29.900



Kuti magazinimi plastike

BPC5000

- Permasa: 8.7x4x12.2 cm

ERE



Çmimi
5.990

Dollap plastik

BPC4000

- 1 Ndarje
- Permasa: 92x68x36 cm

ERE



Çmimi
7.500

Dollap plastik me 4 ndarje

BPC7000

- 4 Ndarje
- Permasa: 171x68x38 cm

ERE



Çmimi
11.500

Dollap plastik me 3 ndarje

BPC6000

- 3 Ndarje
- Permasa: 171x68x38 cm

ERE



Çmimi
9.900

Raft I palosshem per garderobe

BPC1500

- Permasa 130 x 45 x 175 cm
- Bazament Metalik

ERE



Çmimi
3.990

Raft metali me 3 ndarje

BTW9044

- Per lavatrice
- Permasa: 68x25x166 cm
- I bardhe

ERE



Çmimi
3.500

Tapet bari artificial



ERE

Kodi	Permasa	Çmimi
BPN2110	20 mm x 1 m x 25 m	29.000
BPN2130	20 mm x 2 m x 10 m	29.900

Shtrese per tapete bari



ERE

Kodi	Permasa	Çmimi
BPN1300	1 m x 10 m 90 Gsm	990
BPN1305	2 m x 50 m 90 Gsm	7.500

Pani rjete hije per mbulim serash



Kodi	Permasa	Çmimi
SN1500	125Gsm 90%, 1x50m	5.990
SN1550	125Gsm 90%, 1,5x50m	9.900
SN2050	125Gsm 90%, 2x50m	11.500
SN3050	125Gsm 90%, 3x50m	18.500
SN4050	125Gsm 90%, 4x50m	22.500
SN5050	125Gsm 90%, 5x50m	27.500
SN6050	125Gsm 90%, 6x50m	35.900

MBULESE UNIVERSALE



Kodi	Permasa	Çmimi
BTR2000	2 m x 3 m 60 Gr	490
BTR2040	4 m x 6 m 60 Gr	1.900
BTR2050	5 m x 8 m 60 Gr	2.500
BTR2060	6 m x 10 m 60 Gr	4.250

Rrjete dekorative me gjethe

BPN1200

• Gjatesia: 3 x 1 m



Çmimi
4.900



Mbulese per hije



88740

• Gjatesia: 1.5m x 10 m,
90 gsm



Çmimi
2.500



Rrjete sigurie plastike per ballkone



Kodi	Permasa	Çmimi
BPN1450	1 m x 50 m E bardhe	8.900
BPN1550	1 m x 50 m E zeze	8.900
BPN1650	1 m x 50 m Gri	8.900
BPN1750	1 m x 50 m Jeshile	8.900

Rrjete sigurie plastike per ballkone



ERE

Kodi	Permasa	Çmimi
BPN1850	1.2 m x 50 m E bardhe	9.900
BPN1950	1.2 m x 50 m E zeze	9.900
BPN2050	1.2 m x 50 m Gri	9.900

Top rrjete teli zingato me saldim



ERE

Kodi	Permasa	Çmimi
BDA2020	1 m x 25 m / 12.2 Kg	7.500
BDA2025	1 m x 25 m / 8.3 Kg	5.390

Top rrjete teli zingato



ERE

Kodi	Permasa	Çmimi
BDA2000	0.8 m x 25 m / 6.6 Kg	2.990
BDA2005	1.0 m x 25 m / 8.3 Kg	3.590
BDA2010	1.0 m x 25 m / 9.9 Kg	4.590
BDA2015	1.2 m x 25 m / 4.8 Kg	2.390

Top rrjete gri per dritare



ERE

Kodi	Permasa	Çmimi
BDA2030	0.8 m x 30 m / 1/2"	3.590
BDA2035	1.0 m x 30 m / 1/2"	4.290
BDA2040	1.2 m x 30 m / 1/2"	5.290
BDA2045	1.5 m x 30 m / 1"	6.390

Mbulese universale shiu

VOREL



Kodi	Permasa	Çmimi
85122	2m x 3m, 57 gsm	250
85124	4m x 5m, 57 gsm	950
85116	5m x 8m, 75 gsm	2.500
85118	6m x 10m, 75 gsm	2.900

PROFESSIONAL SERVICE

Jemi të lumtur t'ju shërbejmë edhe pas shitjes. Ne ju ofrojmë një shërbim të shkëlqyer servisi, që bën dallimin midis një blerjeje rutinë dhe një partneriteti afatgjatë. Ecuria jonë e gjatë në fushën e shërbimit teknik na ka lejuar të krijojmë një rrjet të fortë bashkëpunimi me klientët tanë, duke u ofruar atyre jo vetëm një shërbim cilësor, por edhe një eksperiencë të paharrueshme. Me poshtë do të gjeni listën e çmimeve të shërbimit të servisit, ku vegla juaj do të kthehet në gjendje funksionale e gatshme për të kryer punët sikur të ishte e re. Ne jemi këtu për t'ju ndihmuar në çdo mënyrë që të mundemi.



KATEGORIA	LLOJI I DIFEKTIT	EASY PRO	COMFORT PRO	PREMIUM PRO
ELEKTROKOSA, FRYRESE GJETHESH ELEKTRIKE	DIFEKT MEKANIK	1,500	2,500	3,500
	DIFEKT ELEKTRIK	1,900	2,900	4,500
KORRESE BARI ELEKTRIKE, ELEKTROSHARRA KRASITESH LIGUSTRASH	DIFEKT MEKANIK	3,500	4,500	6,900
	DIFEKT ELEKTRIK	4,500	4,900	7,900
TRAPAN ELEKTRIK GURE FLEKSIBEL I VOGEL	DIFEKT MEKANIK	1,500	2,500	3,500
	DIFEKT ELEKTRIK	1,900	2,900	4,500
TRAPAN ME BATERI	DIFEKT MEKANIK	1,500	2,500	3,900
	DIFEKT ELEKTRIK	1,900	2,900	5,500
MATRAPIK SDS-PLUS GURE FLEKSIBEL I MADH,	DIFEKT MEKANIK	3,500	4,500	6,900
	DIFEKT ELEKTRIK	4,500	5,500	7,900
MATRAPIK SDS-MAX	DIFEKT MEKANIK	5,900	8,900	14,500
	DIFEKT ELEKTRIK	6,900	9,900	16,500

KATEGORIA	LLOJI I DIFEKTIT	EASY PRO	COMFORT PRO	PREMIUM PRO
POMPA UJI SIPERFAQESORE	DIFEKT MEKANIK	1,500	2,500	3,500
	DIFEKT ELEKTRIK	1,900	2,900	3,900
POMPA ZHYTESE PUSI 4"	DIFEKT MEKANIK	5,500	7,900	12,500
	DIFEKT ELEKTRIK	6,500	8,900	14,500
LARESE ME PRESION DHE ASPIRATORË	DIFEKT MEKANIK/ ELEKTRIK	4,500	6,500	9,500
MAKINERI ME MOTOR 2T ME BENZINE MOTOKOSA MOTOSHARRA	DIFEKT MEKANIK	3,900	4,900	6,900
	DIFEKT MOTORIK	4,900	6,900	9,900
MAKINERI ME MOTOR 4T ME BENZINE KORRESE BARI FREZA	DIFEKT MEKANIK	5,900	7,500	11,500
	DIFEKT MOTORIK	7,900	9,900	14,500
SHARRA ME MAJA SHARRA RRETHORE ZMERILUESE ELEKTRIKE	DIFEKT MEKANIK	2,500	3,500	5,500
	DIFEKT ELEKTRIK	2,900	3,900	7,500
TRONKATRICE ELEKTRIKE	DIFEKT MEKANIK	5,900	7,500	11,500
	DIFEKT ELEKTRIK	7,900	9,900	14,500
VEGLA ME AJER	DIFEKT MEKANIK	2,500	3,500	4,500
KOMPRESORET 24-50 LIT	DIFEKT MEKANIK	3,500	5,500	6,500
	DIFEKT ELEKTRIK	4,500	6,500	7,500
KOMPRESORET 100-200 LIT	DIFEKT MEKANIK	12,500	14,500	17,500
	DIFEKT ELEKTRIK	13,500	16,500	19,500
KOMPRESORET 300-500 LIT	DIFEKT MEKANIK	24,500	34,500	45,500
	DIFEKT ELEKTRIK	27,500	37,500	49,500

PROFESSIONAL SERVICE



Ne ju garantojmë pjesët origjinale, për të gjitha makineritë e shitura nga ne, në 10 vitet e fundit.









Të gjitha këto pjesë mund të porositen, me çmimet më të mira në treg, në pikat më të afërta të shitjes, si edhe pranë serviseve të autorizuara. Aktualisht ne kemi investuar në një stok të qëndrueshëm me rreth 3.000 pjesë këmbimi.

MOTOKOSE

52 CC

CGTB52







1E44F-2A-1	1E44F-2A.1	1E44F-2A.1
		
Cilinder	Karburator	Bobine ndezese
1E44F-2A.2-1	1E44F-2A.2-4	1E40F-5A.4.1
		
Piston	Fasho pistoni	Serbator
1E40F-5.11	1E40F-5.7-1	CG305F.1-4
		
Starter komplet	Starter i brendshem	Dado e kundert

MOTOKOSE

43-33-25.4 CC

CGTB43-33-25cc



CG415.2	1E34F.13	1E34F-12
		
Xhunto transmi.	Karburator	Bobine ndezese
CG330B.1	1E32FL.6.2	1E40F-5B.4.1
		
Tub + shufer trasnmisioni	Tape serbatori	Serbator
CG420.2-3	CG260B-CE.1.1	CG260.2.1
		
Shufer transmisioni	Doreze gazi	Kembane freksioni

GJENERATOR

63CC

LT950DC



305800LT950DC	3058000005001	30580KLT950DC
Cilinder	Guarnicion cilindri	Koke cilindri
3058000031003	30580ULT950DC	3012002000001
Piston	Fasho pistoni	Celes
3058000037001	3058000028001	3058000012001
Karburator	Kollodok + bielle	Kapak starteri

GJENERATOR ME NAFTE

2 KW

LDG2200CLE



46LTP	2019000205001
Rrota rezerve 8"	
3049010400500	2010000003000
Pistoni	Depozite benzine

POMPA PRESIONI

FET100- 200



FET100-H	FET150-H
Helike pompe FET100	Helike pompe FET15
FET200-H	FXH-2540
Helike pompe FET200	MUFTE KABLLI POMPE PUSI

MOTOR ME BENZINE

208 CC

LT210



G1214E1201000	G1311E0101000	G1320E0101000
Cilinder	Piston	Fasho pistoni
G1230E0102000	G1501E0101H20	1E40F-5B.4.1
Guarnicion cilindri	Sinjalizues vaji	Celes fikje
G1668E0101010	CG260B-CE.1.1	CG260.2.1
Valvul kontrolli	Tape benzine	Kapak starteri

POMPA VOLUMETRIKE

FB60/ FB70/FB80



FB60-H/FGPB125	FB60-P/FGP125
Helike pompe FB60	Permistop FB60
FB80-H	FB70-P
Helike pompe FB80	Permistop FB70

POMPA CENTRIFUGALE

FCP130 - FCP170-H



FCP130-H	FCP158-H
Helike pompe FCP130	Helike pompe FCP158
FCP170-H	FCP200-H
Helike pompe FCP170	Helike pompe FCP130

KORRESE BARI

51 cm

GLM196201



GLM196201-SP-103	GLM196201-SP-2	GLM196201-SP-63
Piston	Kapak starteri	Filter ajri
GLM196201-SP-71	GLM196201-SP-B15	
Karburator	Rrote komplet 8''	Thike

GJENERATOR NAFTE SILENCIOZ

GSE50003



GSE50003-SP-1-7-8	GSE50003-SP-B10-11	GSE50003-SP-B10-9
Rregullator tensioni	Rregullator rryme karikimi	Pakete
GSE50003-SP-B2-5	GSE50003-SP-B7-22	GSE50003-SP-B9-1
Helike motor	Filter benzine	Celes starti

POMPE CENTRIFUGALE

CPM7508



CPM7508-SP-10	CPM7508-SP-18	CPM7508-SP-39
Premistop	Kondesator	Freskuese
CPM7508-SP-40	CPM7508-SP-9	
Mbrotjese ventitalori	Freskuese	

FREZE TOKE

6.5 hp

GC6101



GC6101-SP-7-1	GC6101-SP-8-7
Thike freze e majte	Koperton gome 3.5-6
GC6101-SP-E6-5	GC6101-SP-E7-1
Kapak starti	Bobine

POMPE UJI

370 W

VPM37018



VPM37018-SP-11	VPM37018-SP-15	VPM37018-SP-26
Premistop	Kapak i siperm	Freskuese
VPM37018-SP-6	VPM37018-SP-7	VPM37018-SP-8
Valvul sigurie	Unaze	Helike

POMPE JET

750 W

JP07508



JP07508-SP-15	JP07508-SP-16
Helike	Premistop
JP07508-SP-43	JPT07508-SP-47
Freskuese	Tub flesibel

MOTOSHARRE KRASITSE ME BENZINE

GCS5261011



GCS5261011-SP-16	GCS5261011-SP-24-26	GCS5261011-SP-33
Pompe vaji	Freksion	Filter benzine
GCS5261011-SP-55	GCS5261011-SP-56	GCS5261011-SP-59
Piston	Fasho Pistoni	Cilinder per motosharre krasitese
GCS5261011-SP-67	GCS5261011-SP-80	GCS5261011-SP-95
Bobine ndezje	Kapak starti	Karburator

KORRESE ELEKTRIKE

380 cm 1600 W

LM385



LM385-SP-11	LM385-SP-28	LM385-SP-30
Kase plastike	Rrip motori	Thike per Korrese
LM385-SP-36	LM385-SP-4-13	LM385-SP-7
Set rrotash	Motori elektrik	Kuzhinete

MOTOPOMPE BENZINE

2"

GWP202



GWP202-SP-12	GWP202-SP-1-25	GWP202-SP-1-39
Helike	Karburator	Piston
GWP202-SP-1-52	GWP202-SP-1-54	
Kapak starteri	Bobine ndezje	

MOTOKOSE

52 CC

GBC5524421



GBC5524421-SP-1-22	GBC5524421-SP-1-36	GBC5524421-SP-1-40
Filter ajri sfungjer	Karburator	Bobine ndezese
GBC5524421-SP-1-41	GBC5524421-SP-1-5	GBC5524421-SP-1-52
Cilinder	Starter komplet	Fasho pistoni
GBC5524421-SP-1-53-5	GBC5524421-SP-1-57	GBC5524421-SP-1-8
Piston komplet	Serbator	Starter i brendshem

KORRESE BARI

46 cm

GLM141181



GLM141181-SP-27	GLM141181-SP-50	GLM141181-SP-90-B39
Karburator	Piston	Tel Gazi
GLM141181-SP-90-B3	GLM141181-SP-96	GLM141181-SP-90-B12
Thike	Kapak starteri	Set rrotash 8"

MOTOPOMPE NAFTE

2"

GEP201



GEP201-SP-38	GEP201-SP-44
Rubinet benzine	Filter benzine
GEP201-SP-47	GEP201-SP-A.F.A
Injektore nafte	Filter ajri

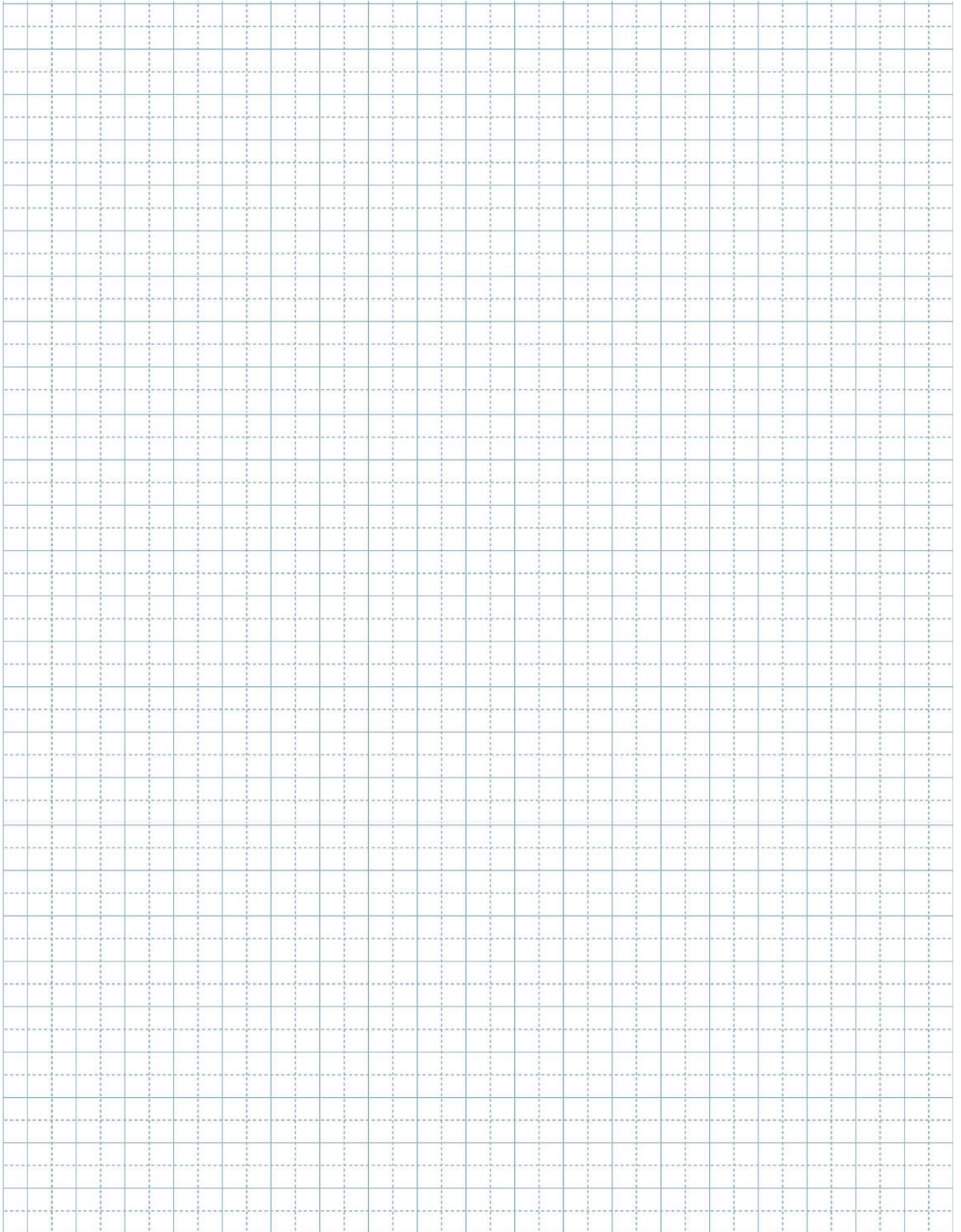

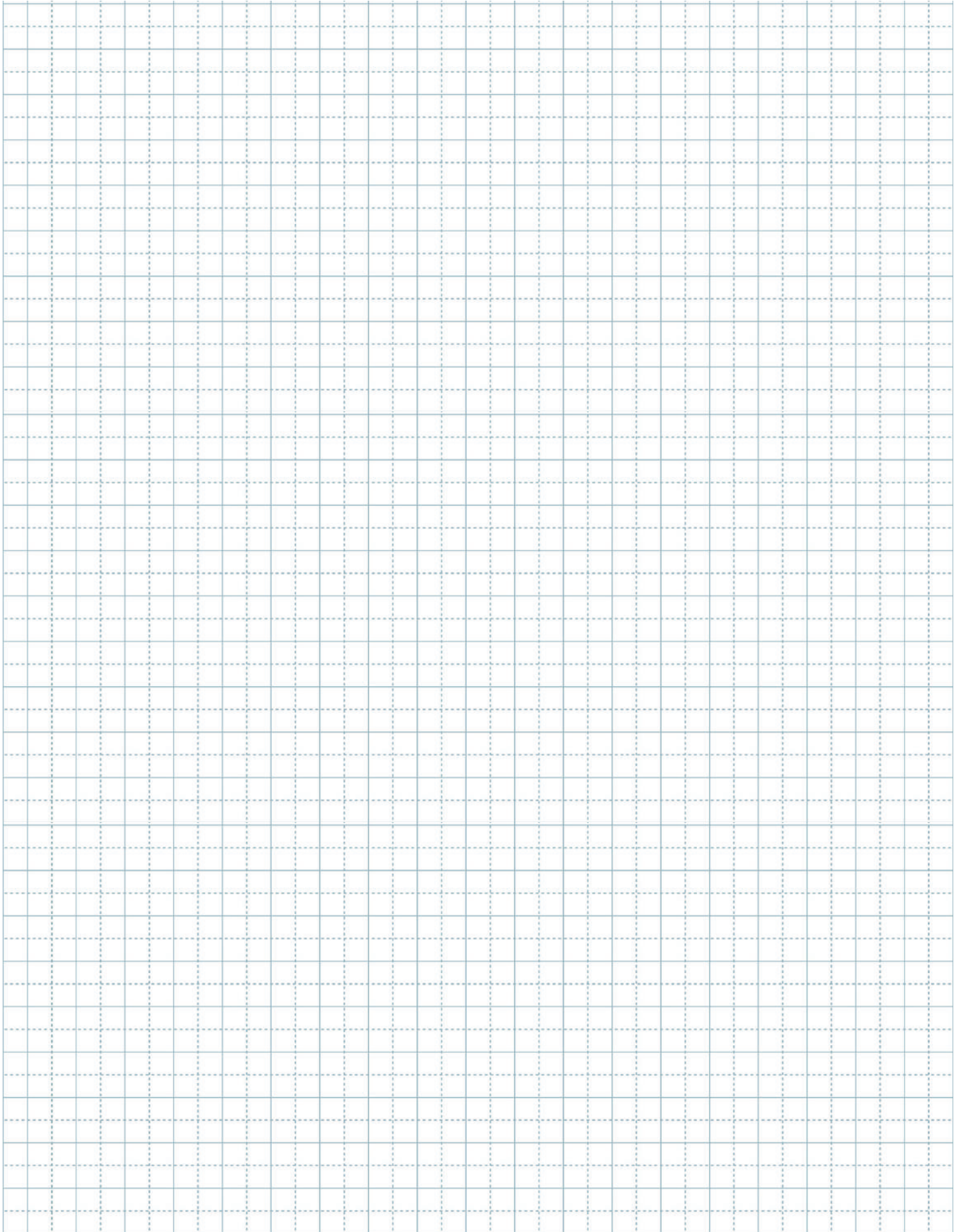

KRAFT



KRAFT ALBANIA

Autostrada TR-DR Km 3

1051 Tiranë

Email: info@kraft.al

Web: www.kraft.al

Tel: +355 69 405 6664